

CANDIDATE  
NAME

|  |
|--|
|  |
|--|

CENTRE  
NUMBER

|  |  |  |  |  |
|--|--|--|--|--|
|  |  |  |  |  |
|--|--|--|--|--|

CANDIDATE  
NUMBER

|  |  |  |  |
|--|--|--|--|
|  |  |  |  |
|--|--|--|--|

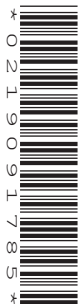

**MATHEMATICS**

**0580/41**

Paper 4 (Extended)

**October/November 2017**

**2 hours 30 minutes**

Candidates answer on the Question Paper.

Additional Materials:      Electronic calculator  
   Tracing paper (optional)

Geometrical instruments

**READ THESE INSTRUCTIONS FIRST**

Write your Centre number, candidate number and name on all the work you hand in.

Write in dark blue or black pen.

You may use an HB pencil for any diagrams or graphs.

Do not use staples, paper clips, glue or correction fluid.

**DO NOT WRITE IN ANY BARCODES.**

Answer **all** questions.

If working is needed for any question it must be shown below that question.

Electronic calculators should be used.

If the degree of accuracy is not specified in the question, and if the answer is not exact, give the answer to three significant figures. Give answers in degrees to one decimal place.

For  $\pi$ , use either your calculator value or 3.142.

At the end of the examination, fasten all your work securely together.

The number of marks is given in brackets [ ] at the end of each question or part question.

The total of the marks for this paper is 130.

This document consists of **19** printed pages and **1** blank page.

- 1 (a) A library has a total of 10 494 fiction and non-fiction books.  
The ratio fiction books : non-fiction books = 13 : 5.

Find the number of non-fiction books the library has.

..... [2]

- (b) The library has DVDs on crime, adventure and science fiction.  
The ratio crime : adventure : science fiction = 11 : 6 : 10.  
The library has 384 **more** science fiction DVDs than adventure DVDs.

Calculate the number of crime DVDs the library has.

..... [2]

- (c) Every Monday, Sima travels by car to the library.  
The distance is 20 km and the journey takes 23 minutes.

- (i) Calculate the average speed for the journey in kilometres per hour.

..... km/h [2]

- (ii) One Monday, she is delayed and her average speed is reduced to 32 km/h.

Calculate the percentage increase in the journey time.

..... % [5]

- (d) In Spain, the price of a book is 11.99 euros.  
In the USA, the price of the same book is \$12.99 .  
The exchange rate is \$1 = 0.9276 euros.

Calculate the difference between these prices.  
Give your answer in dollars, correct to the nearest cent.

\$..... [3]

- (e) 7605 books were borrowed from the library in 2016.  
This was 22% less than in 2015.

Calculate the number of books borrowed in 2015.

..... [3]

2 (a)

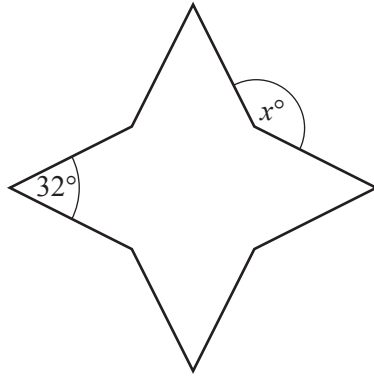
NOT TO  
SCALE

The diagram shows an octagon.  
All of the sides are the same length.  
Four of the interior angles are each  $32^\circ$ .  
The other four interior angles are equal.

Find the value of  $x$ .

$$x = \dots\dots\dots [4]$$

(b)

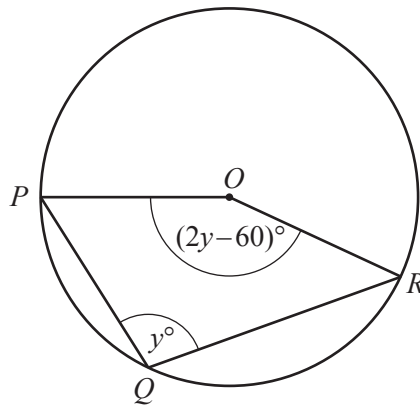
NOT TO  
SCALE

$P$ ,  $Q$  and  $R$  lie on a circle, centre  $O$ .  
Angle  $PQR = y^\circ$  and angle  $POR = (2y - 60)^\circ$ .

Find the value of  $y$ .

$$y = \dots\dots\dots [3]$$

3 (a) Solve.

$$11x + 15 = 3x - 7$$

$$x = \dots\dots\dots [2]$$

(b) (i) Factorise.

$$x^2 + 9x - 22$$

$$\dots\dots\dots [2]$$

(ii) Solve.

$$x^2 + 9x - 22 = 0$$

$$x = \dots\dots\dots \text{ or } x = \dots\dots\dots [1]$$

(c) Rearrange  $y = \frac{2(x-a)}{x}$  to make  $x$  the subject.

$$x = \dots\dots\dots [4]$$

(d) Simplify.

$$\frac{x^2 - 6x}{x^2 - 36}$$

$$\dots\dots\dots [3]$$

4

$$f(x) = x^3 - 4x^2 + 15$$

(a) Complete the table of values for  $y = f(x)$ .

|     |    |    |      |    |    |   |     |   |     |    |      |
|-----|----|----|------|----|----|---|-----|---|-----|----|------|
| $x$ | -2 | -1 | -0.5 | 0  | 1  | 2 | 2.5 | 3 | 3.5 | 4  | 4.5  |
| $y$ | -9 |    | 13.9 | 15 | 12 |   | 5.6 | 6 | 8.9 | 15 | 25.1 |

[2]

(b) On the grid, draw the graph of  $y = f(x)$  for  $-2 \leq x \leq 4.5$ .

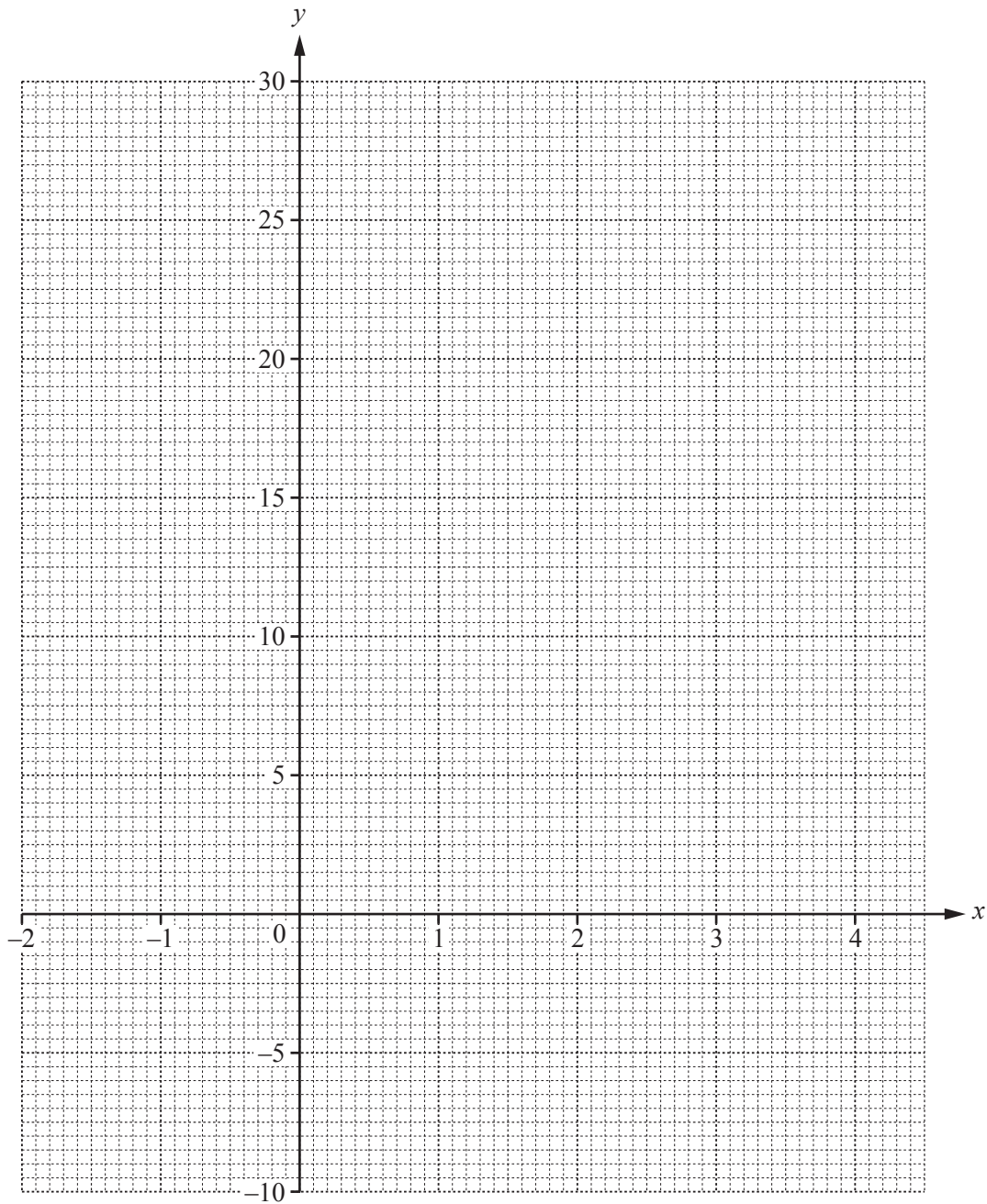

[4]

(c) Use your graph to solve the equation  $f(x) = 0$ .

$x = \dots\dots\dots$  [1]

(d) By drawing a suitable tangent, estimate the gradient of the graph of  $y = f(x)$  when  $x = 3.5$ .

$\dots\dots\dots$  [3]

(e) By drawing a suitable straight line on the grid, solve the equation  $x^3 - 4x^2 - 2x + 5 = 0$ .

$x = \dots\dots\dots$  or  $x = \dots\dots\dots$  or  $x = \dots\dots\dots$  [4]

- 5 The histogram shows the distribution of the masses,  $m$  grams, of 360 apples.

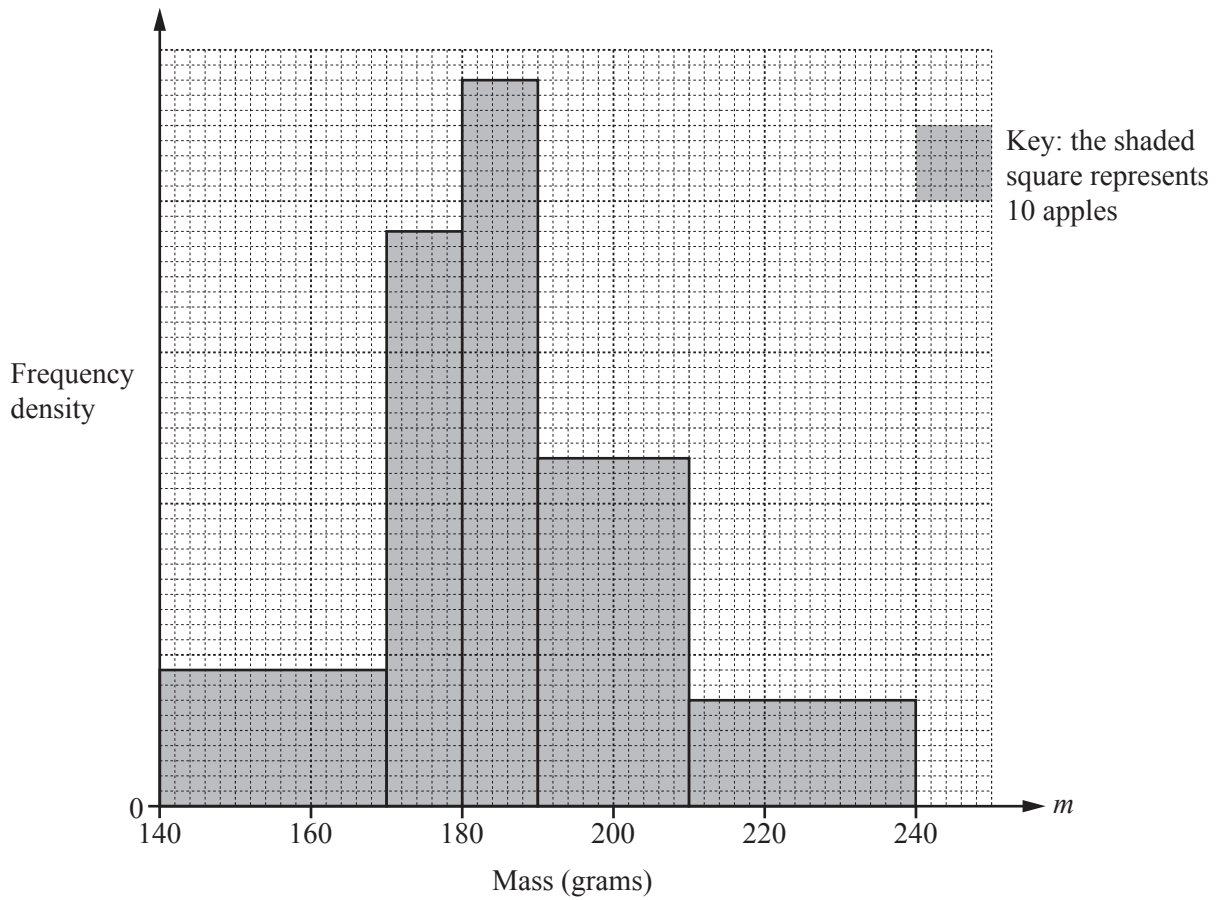

- (a) Use the histogram to complete the frequency table.

| Mass ( $m$ grams)  | Number of apples |
|--------------------|------------------|
| $140 < m \leq 170$ |                  |
| $170 < m \leq 180$ |                  |
| $180 < m \leq 190$ |                  |
| $190 < m \leq 210$ | 92               |
| $210 < m \leq 240$ | 42               |

[3]



(b) Calculate an estimate of the mean mass of the 360 apples.

..... g [4]

6

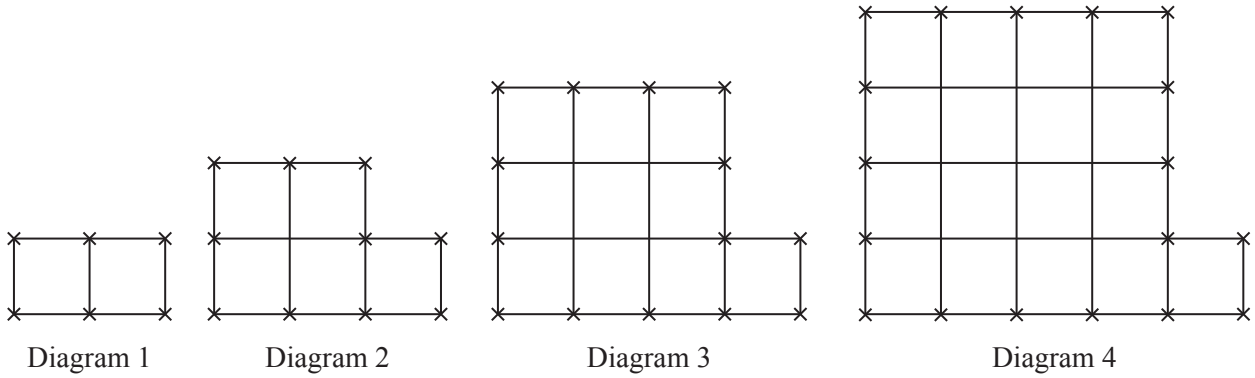

These are the first four diagrams in a sequence.  
Each diagram is made from small squares and crosses.

(a) Complete the table.

|                         |   |    |    |   |   |  |     |
|-------------------------|---|----|----|---|---|--|-----|
| Diagram                 | 1 | 2  | 3  | 4 | 5 |  | $n$ |
| Number of crosses       | 6 | 10 | 14 |   |   |  |     |
| Number of small squares | 2 | 5  | 10 |   |   |  |     |

[6]

(b) Find the number of crosses in Diagram 60.

..... [1]

(c) Which diagram has 226 squares?

Diagram ..... [1]

(d) The side of each small square has length 1 cm.  
The number of lines of length 1 cm in Diagram  $n$  is  $2n^2 + 2n + q$ .

Find the value of  $q$ .

$q =$  ..... [2]

7             $f(x) = 3 - 2x$              $g(x) = \frac{4}{x}, x \neq 0$              $h(x) = 4^x$

(a) Find  $f(5)$ .

..... [1]

(b) Find  $gh(3)$ .

..... [2]

(c) Find  $f^{-1}(x)$ .

$f^{-1}(x) =$  ..... [2]

(d) Show that  $hf(x) = \frac{64}{16^x}$ .

[3]

(e) Find the value of  $x$  when  $h(x) = g(0.5)$ .

$x =$  ..... [2]

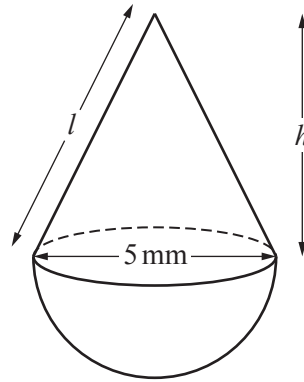

NOT TO  
SCALE

The diagram shows a solid made from a hemisphere and a cone.  
The base diameter of the cone and the diameter of the hemisphere are each 5 mm.

- (a) The total surface area of the solid is  $\frac{115\pi}{4}$  mm<sup>2</sup>.

Show that the slant height,  $l$ , is 6.5 mm.

[The curved surface area,  $A$ , of a cone with radius  $r$  and slant height  $l$  is  $A = \pi rl$ .]

[The surface area,  $A$ , of a sphere with radius  $r$  is  $A = 4\pi r^2$ .]

[4]

- (b) Calculate the height,  $h$ , of the cone.

$h = \dots\dots\dots$  mm [3]

- (c) Calculate the volume of the solid.

[The volume,  $V$ , of a cone with radius  $r$  and height  $h$  is  $V = \frac{1}{3}\pi r^2 h$ .]

[The volume,  $V$ , of a sphere with radius  $r$  is  $V = \frac{4}{3}\pi r^3$ .]

.....mm<sup>3</sup> [4]

- (d) The solid is made from gold.  
1 **cubic centimetre** of gold has a mass of 19.3 grams.  
The value of 1 gram of gold is \$38.62 .

Calculate the value of the gold used to make the solid.

\$..... [3]

- 9 (a) A bag contains red beads and green beads.  
There are 80 beads altogether.  
The probability that a bead chosen at random is green is 0.35 .

(i) Find the number of red beads in the bag.

..... [2]

- (ii) Marcos chooses a bead at random and replaces it in the bag.  
He does this 240 times.

Find the number of times he would expect to choose a green bead.

..... [1]

- (b) A different bag contains 2 blue marbles, 3 yellow marbles and 4 white marbles.  
Huma chooses a marble at random, notes the colour, then replaces it in the bag.  
She does this three times.

Find the probability that

(i) all three marbles are yellow,

..... [2]

- (ii) all three marbles are different colours.

..... [3]

- (c) Another bag contains 2 green counters and 3 pink counters.  
Teresa chooses three counters at random **without** replacement.

Find the probability that she chooses more pink counters than green counters.

..... [4]

10

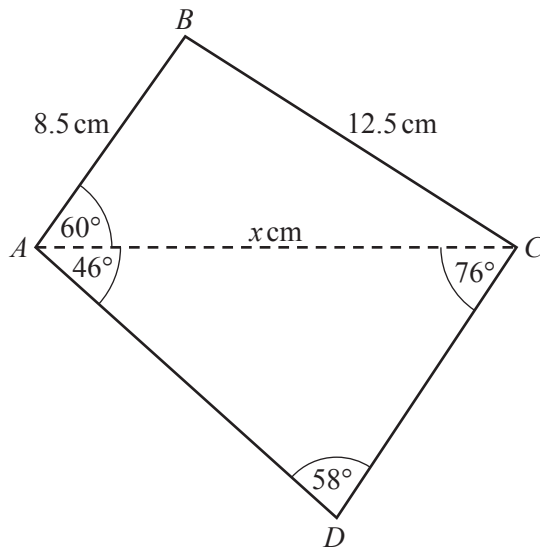
NOT TO  
SCALE

The diagram shows a quadrilateral  $ABCD$ .

- (a) The length of  $AC$  is  $x$  cm.

Use the cosine rule in triangle  $ABC$  to show that  $2x^2 - 17x - 168 = 0$ .

[4]

- (b) Solve the equation  $2x^2 - 17x - 168 = 0$ .  
Show all your working and give your answers correct to 2 decimal places.

$x = \dots\dots\dots$  or  $x = \dots\dots\dots$  [4]



(c) Use the sine rule to calculate the length of  $CD$ .

$CD = \dots\dots\dots$  cm [3]

(d) Calculate the area of the quadrilateral  $ABCD$ .

$\dots\dots\dots$  cm<sup>2</sup> [3]

11 (a)  $\mathbf{A} = \begin{pmatrix} 2 & -3 \\ 1 & 4 \end{pmatrix}$

Find

(i)  $\mathbf{A}^2$ ,

$$\begin{pmatrix} & \\ & \end{pmatrix} \quad [2]$$

(ii)  $\mathbf{A}^{-1}$ , the inverse of  $\mathbf{A}$ .

$$\begin{pmatrix} & \\ & \end{pmatrix} \quad [2]$$

(b) Describe fully the **single** transformation represented by the matrix  $\begin{pmatrix} -1 & 0 \\ 0 & 1 \end{pmatrix}$ .

.....  
 ..... [2]

(c) Find the matrix that represents a clockwise rotation of  $90^\circ$  about the origin.

$$\begin{pmatrix} & \\ & \end{pmatrix} \quad [2]$$

(d)

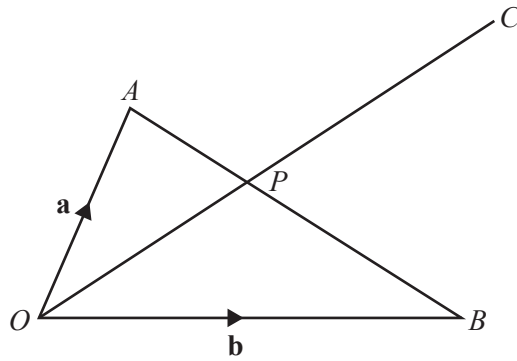

NOT TO SCALE

In the diagram,  $O$  is the origin and  $P$  lies on  $AB$  such that  $AP : PB = 3 : 4$ .  
 $\vec{OA} = \mathbf{a}$  and  $\vec{OB} = \mathbf{b}$ .

(i) Find  $\vec{OP}$ , in terms of  $\mathbf{a}$  and  $\mathbf{b}$ , in its simplest form.

$$\vec{OP} = \dots\dots\dots [3]$$

(ii) The line  $OP$  is extended to  $C$  such that  $\vec{OC} = m\vec{OP}$  and  $\vec{BC} = k\mathbf{a}$ .

Find the value of  $m$  and the value of  $k$ .

$$m = \dots\dots\dots$$

$$k = \dots\dots\dots [2]$$

**BLANK PAGE**

---

Permission to reproduce items where third-party owned material protected by copyright is included has been sought and cleared where possible. Every reasonable effort has been made by the publisher (UCLES) to trace copyright holders, but if any items requiring clearance have unwittingly been included, the publisher will be pleased to make amends at the earliest possible opportunity.

To avoid the issue of disclosure of answer-related information to candidates, all copyright acknowledgements are reproduced online in the Cambridge International Examinations Copyright Acknowledgements Booklet. This is produced for each series of examinations and is freely available to download at [www.cie.org.uk](http://www.cie.org.uk) after the live examination series.

Cambridge International Examinations is part of the Cambridge Assessment Group. Cambridge Assessment is the brand name of University of Cambridge Local Examinations Syndicate (UCLES), which is itself a department of the University of Cambridge.