



---

**COMPUTER SCIENCE**

**0478/13**

Paper 1

**October/November 2016**

MARK SCHEME

Maximum Mark: 75

---

**Published**

This mark scheme is published as an aid to teachers and candidates, to indicate the requirements of the examination. It shows the basis on which Examiners were instructed to award marks. It does not indicate the details of the discussions that took place at an Examiners' meeting before marking began, which would have considered the acceptability of alternative answers.

Mark schemes should be read in conjunction with the question paper and the Principal Examiner Report for Teachers.

Cambridge will not enter into discussions about these mark schemes.

Cambridge is publishing the mark schemes for the October/November 2016 series for most Cambridge IGCSE<sup>®</sup>, Cambridge International A and AS Level components and some Cambridge O Level components.

<b>Page 2</b>	<b>Mark Scheme</b>	<b>Syllabus</b>	<b>Paper</b>
	<b>Cambridge IGCSE – October/November 2016</b>	<b>0478</b>	<b>13</b>

- 1** In any order:
- Fetch
  - Decode
  - Execute
- [3]

- 2**
- Hacking
  - Virus
  - Cookies
  - Cracking
  - Pharming
- [5]

3

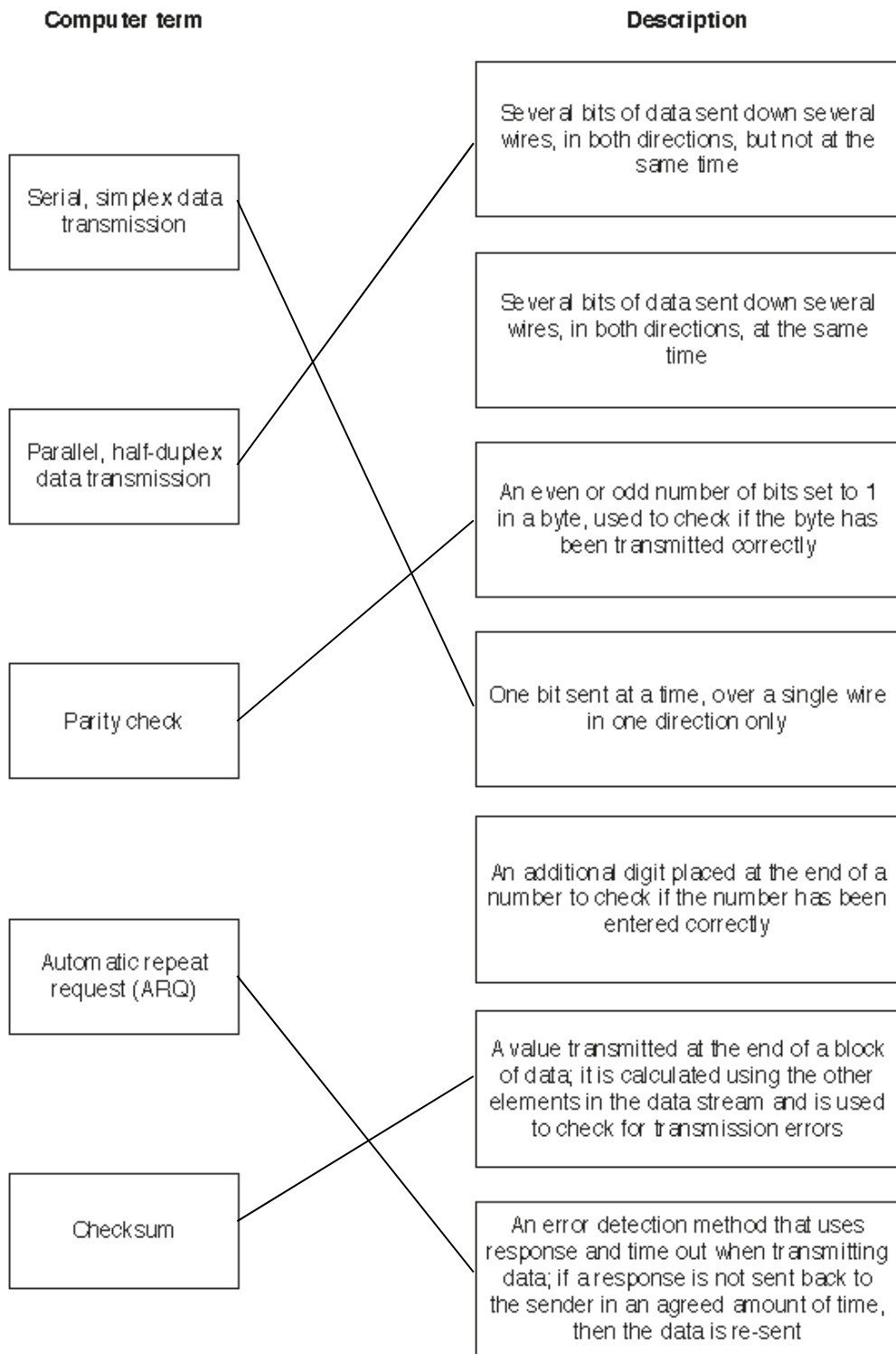

[5]

<b>Page 4</b>	<b>Mark Scheme</b>	<b>Syllabus</b>	<b>Paper</b>
	<b>Cambridge IGCSE – October/November 2016</b>	<b>0478</b>	<b>13</b>

4 (a) Any **two** from:

- Easy to make a mistake
- Can be slow if not trained
- Dirt/food can get into keys

[2]

(b) Any **two** with identification and explanation from:

- Fewer typing errors may be made ...
- ... because one button is pressed to order an item
- Speed up the time to enter an order ...
- ... because fewer buttons are pressed to complete the order
- May require less training ...
- ... because it is easier to identify an order item from its image rather than typing it
- Can stop dirt/food damage ...
- ... normally has a protective layer // because there are no keys for dirt/food to get into

[4]

(c) 1 mark for security measure, 1 mark for description.

Any **two** from:

- Encryption
- If the data is accessed or stolen it will be meaningless
  
- Biometric device
- Can help prevents unauthorised access to the system (only award once)
  
- Firewall
- Can alert to show unauthorised access attempt on the system
- Can help prevent unauthorised access to the system (only award once)
- Can help protect against viruses and malware entering the system
  
- Anti-spyware
- Can stop the keys being logged that, when analysed, would reveal the password to the data

[4]

5 (a) 1 mark per correct section.

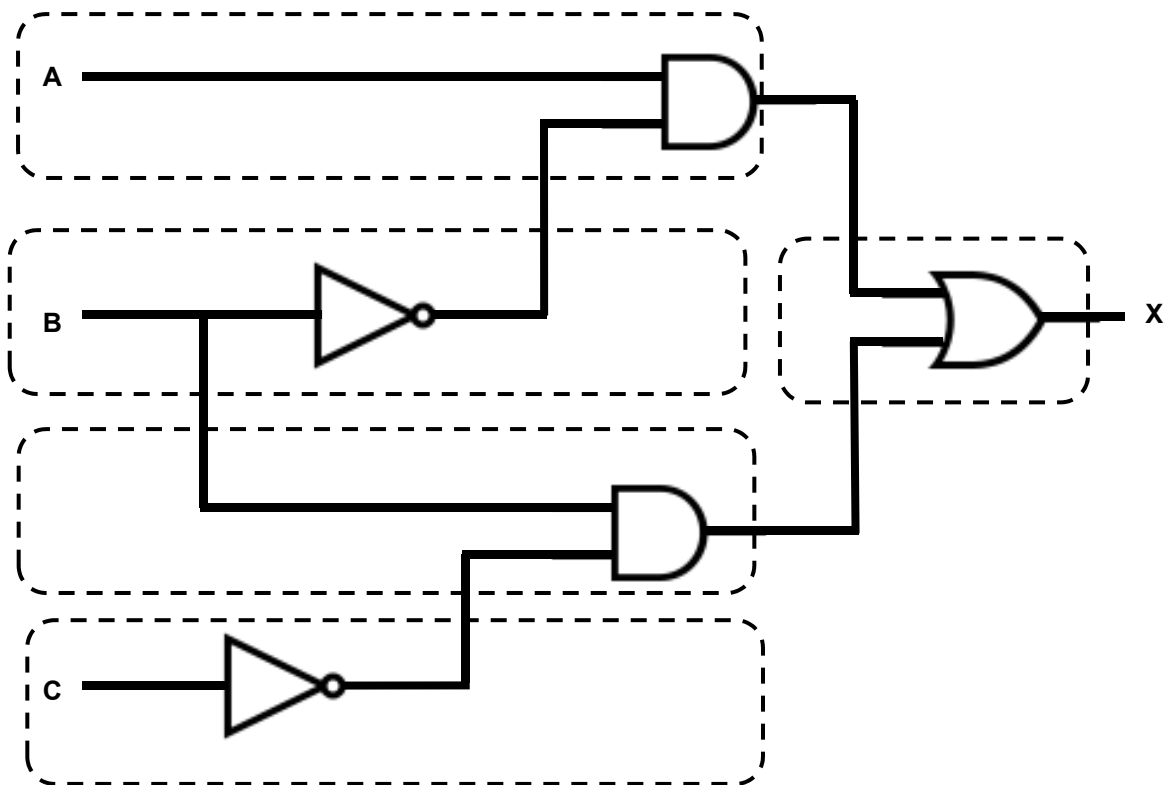

[5]

(b) 4 marks for 8 correct values  
 3 marks for 6 correct values  
 2 marks for 4 correct values  
 1 mark for 2 correct values

A	B	C	Working space	X
0	0	0		0
0	0	1		0
0	1	0		1
0	1	1		0
1	0	0		1
1	0	1		1
1	1	0		1
1	1	1		0

[4]

Page 6	Mark Scheme	Syllabus	Paper
	Cambridge IGCSE – October/November 2016	0478	13

(c) Register Z [1]

(d) (i) (byte) 5 [1]

(ii) (column) 4 [1]

(iii) corrected byte is: **1 0 0 1 1 1 1 1** [1]

(iv) that gives the value: **1 5 9**  
(follow through applies) [1]

(v) Any **two** from:

- The byte would be transmitted without having 5 consecutive 1's
- The fault condition would not be recognised [2]

6 Any **two** from:

High level language

- easier/faster to write code as uses English-like statements
- easier to modify as uses English-like statements
- easier to debug as uses English-like statements
- portable language code

Any **two** from:

Low level language

- can work directly on memory locations
- can be executed faster
- translated program requires less memory [4]

7 Any **four** from:

- reaches maximum brightness quickly
- colours are vivid
- good colour definition/contrast can be achieved
- screens can be thinner/thin
- more reliable as LED's are long lasting
- consume very little/less energy [4]

8

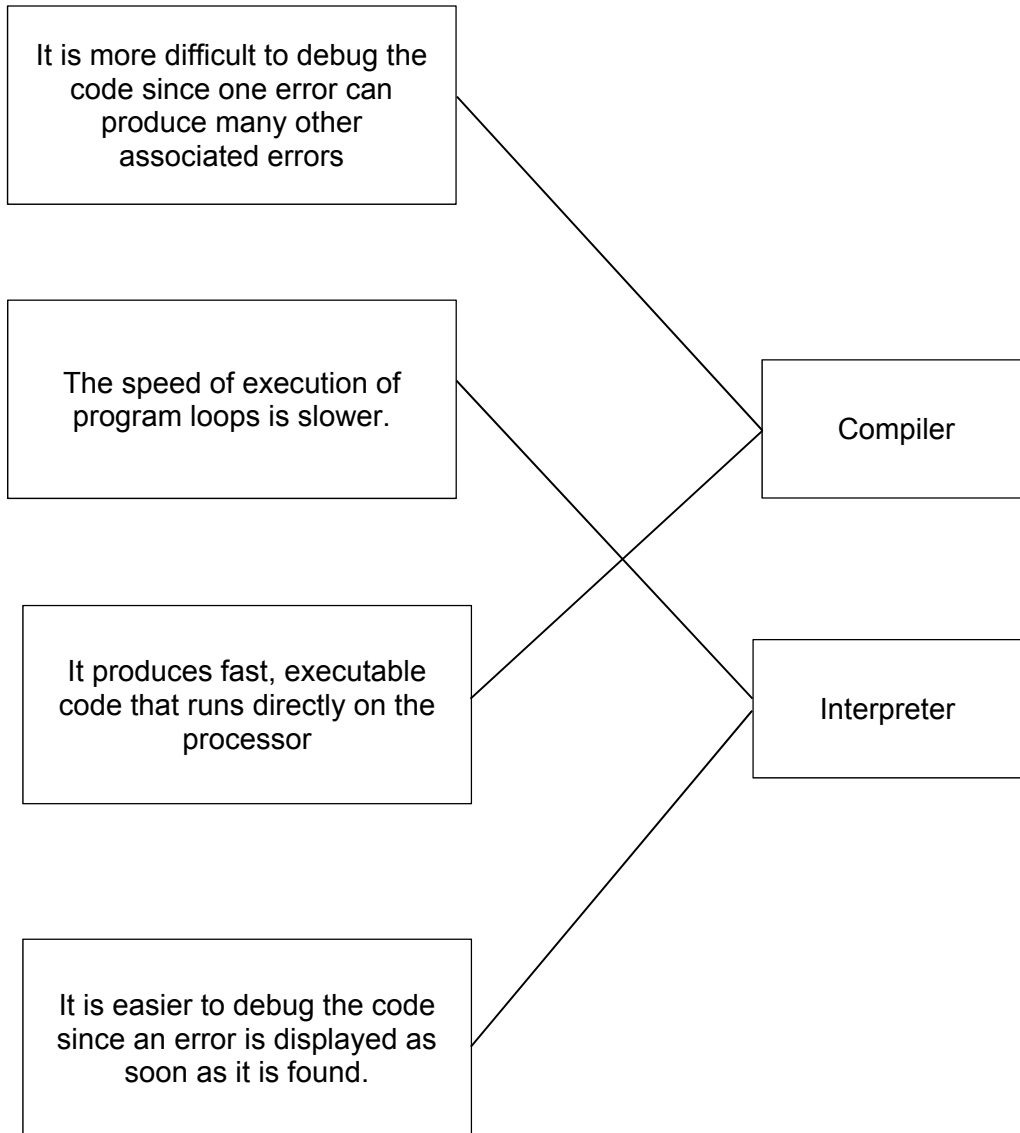

[4]

Page 8	Mark Scheme	Syllabus	Paper
	Cambridge IGCSE – October/November 2016	0478	13

9 Any six from:

- infrared / motion / pressure (sensor) // sensor detects movement/pressure
  - signals/data sent (continuously) to microprocessor
  - converted from analogue to digital (using ADC)
  - microprocessor compares value with those stored in memory
  - if sensor value does not match the stored value(s) ...
  - ... signal sent to switch on the light
  - ... signal sent to keep the light on
  - ... light remains on for a period of time (30 seconds)
  - if sensor value matches the stored value(s) ...
  - ... light will remain off
  - ... will turn off after period of time (30 seconds)
  - works in a continues loop
- [6]

10 (a) (i) 2 marks for 3 correct binary conversions, 1 mark for 2 correct binary conversions [2]

0	0	0	1	1	0	1	0	1	1	1	1
---	---	---	---	---	---	---	---	---	---	---	---

(ii) 1 mark for each correct hex value converted

**1 A F** [3]

(b) 2 marks for working + 1 mark for correct answer

Working

- $1200 \times 8 = 9600$  (bytes)
- $9600/1024$  or  $9600/1000$

Answer

- 9.4 or 9.6 kilobytes [3]

(c) Any one from:

MAC address

- Media Access Control (address)
- unique number that identifies a device (connected to the Internet)
- address is made up of manufacturer id + serial number of device
- address is allocated by the manufacturer

Any one from:

IP address

- Internet Protocol (address)
- location/address of a device on the Internet
- address is unique for given Internet session
- address is supplied when a device connects to the Internet
- address is allocated by the network [2]



<b>Page 9</b>	<b>Mark Scheme</b>	<b>Syllabus</b>	<b>Paper</b>
	<b>Cambridge IGCSE – October/November 2016</b>	<b>0478</b>	<b>13</b>

- (d) – record (layer)  
– handshake (layer) [2]

**11** Any **six** from:

- Help stop the misuse of computers
- The use of computers needs to be governed
- Help keep users safer when using computers
- Provides rules for using computers
- Help stop intellectual property theft
- Helps prevent the misuse of personal information
- Reference to laws (relevant example)
- Reference to security issues (relevant example)

NOTE: Answer must refer to the importance of ethics and be more than a description of ethics. [6]