



UNIVERSITY OF CAMBRIDGE INTERNATIONAL EXAMINATIONS
International General Certificate of Secondary Education

DESIGN AND TECHNOLOGY

0445/13

Paper 1 Design

October/November 2013

1 hour 15 minutes

Candidates answer on the pre-printed A3 Answer Sheets.

Additional Materials: Standard drawing equipment

To be taken together with the optional paper for which you have been entered in one session of 2 hours and 15 minutes.

READ THESE INSTRUCTIONS FIRST

Write your Centre number, candidate number and name in the spaces on **both** printed Answer Sheets.

Write in dark blue or black pen.

You may use a soft pencil for any diagrams, graphs or rough working.

Do not use staples, paper clips, highlighters, glue or correction fluid.

Answer **one** question.

Write/draw your answers in the spaces provided on the Answer Sheets.

You may use a calculator.

At the end of the examination, fasten all your work securely together.

The number of marks is given in brackets [] at the end of each question or part question.

This document consists of **4** printed A4 pages and **2** A3 Inserts.



Answer **one** question only on the A3 pre-printed answer sheets provided.

- 1 Candles are popular methods of providing soft lighting in a room.

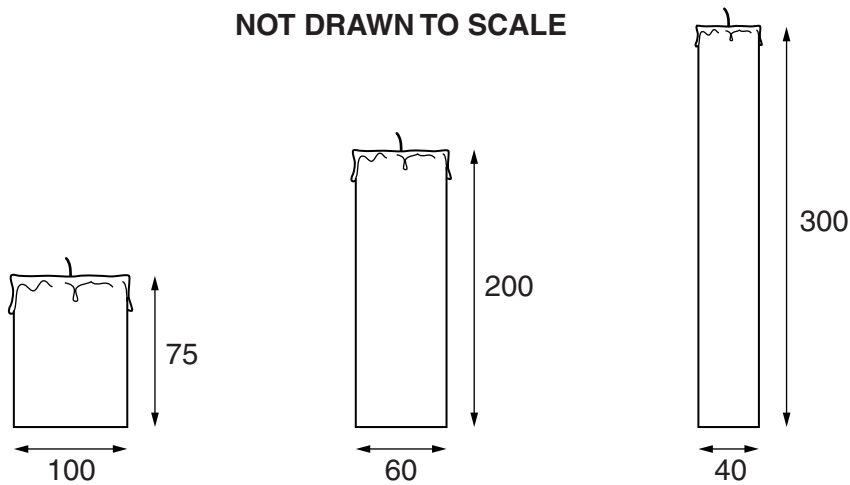

Design a holder to take at least three candles. The candles can be of just one size or a combination of the above sizes.

- (a) List **four** additional points about the function of such a holder that you consider to be important. [4]
- (b) Use sketches and notes to show **two** ways by which candles could be held in place. [4]
- (c) Develop and sketch **three** ideas for the holder. [12]
- (d) Evaluate your ideas and justify why you have chosen **one** idea to develop more fully. [8]
- (e) Draw, using a method of your own choice, a full solution to the problem. Include construction details and major dimensions. [12]
- (f) Suggest suitable specific materials for your solution and give reasons for your choice. [4]
- (g) Outline a method used to manufacture **one** part of your solution in the school workshop. [6]

2 Young children enjoy playing together in 'pretend' situations.



Design a lightweight play house, for children of 3–6 years, that can be easily stored.

- (a) List **four** additional points about the function of such a play house that you consider to be important. [4]
- (b) Use sketches and notes to show **two** methods by which card and other lightweight materials can be hinged. [4]
- (c) Develop and sketch **three** ideas for the play house. [12]
- (d) Evaluate your ideas and justify why you have chosen **one** idea to develop more fully. [8]
- (e) Draw, using a method of your own choice, a full solution to the problem. Include construction details and major dimensions. [12]
- (f) Suggest suitable specific materials for your solution and give reasons for your choice. [4]
- (g) Outline a method of producing a prototype of your solution in the school graphics studio. [6]

- 3 Many gardens have some form of centre piece to add interest and attract attention.



Design a garden feature that uses water to provide some form of movement.

- (a) List **four** additional points about the function of such a garden feature that you consider to be important. [4]
- (b) Use sketches and notes to show **two** ways by which movement could be created by using water. [4]
- (c) Develop and sketch **three** ideas for the garden feature. [12]
- (d) Evaluate your ideas and justify why you have chosen **one** idea to develop more fully. [8]
- (e) Draw, using a method of your own choice, a full solution to the problem. Include construction details and major dimensions. [12]
- (f) Suggest suitable materials for your solution and give reasons for your choice. [4]
- (g) Outline a method used to manufacture **one** part of your solution in the school workshop. [6]

Permission to reproduce items where third-party owned material protected by copyright is included has been sought and cleared where possible. Every reasonable effort has been made by the publisher (UCLES) to trace copyright holders, but if any items requiring clearance have unwittingly been included, the publisher will be pleased to make amends at the earliest possible opportunity.

University of Cambridge International Examinations is part of the Cambridge Assessment Group. Cambridge Assessment is the brand name of University of Cambridge Local Examinations Syndicate (UCLES), which is itself a department of the University of Cambridge.