



UNIVERSITY OF CAMBRIDGE INTERNATIONAL EXAMINATIONS
International General Certificate of Secondary Education

CANDIDATE
NAME

CENTRE
NUMBER

--	--	--	--	--

CANDIDATE
NUMBER

--	--	--	--



CO-ORDINATED SCIENCES

0654/62

Paper 6 Alternative to Practical

May/June 2013

1 hour

Candidates answer on the Question paper.

No Additional Materials are required.

READ THESE INSTRUCTIONS FIRST

Write your Centre number, candidate number and name on all the work you hand in.

Write in dark blue or black pen.

You may use a pencil for any diagrams or graphs.

Do not use staples, paper clips, glue or correction fluid.

DO NOT WRITE IN ANY BARCODES.

Answer **all** questions.

Electronic calculators may be used.

You may lose marks if you do not show your working or if you do not use appropriate units.

At the end of the examination, fasten all your work securely together.

The number of marks is given in brackets [] at the end of each question or part question.

For Examiner's Use	
1	
2	
3	
4	
5	
6	
Total	

This document consists of **18** printed pages and **2** blank pages.



- 1 A student did an experiment with two potted plants, each of which had been enclosed in a transparent polythene bag for a period of two days. During this time, the plants were exposed to bright light.

In one of the polythene bags there was a chemical which absorbs carbon dioxide.

Both plants had parts of their leaves covered with black paper, as shown in Fig. 1.1.

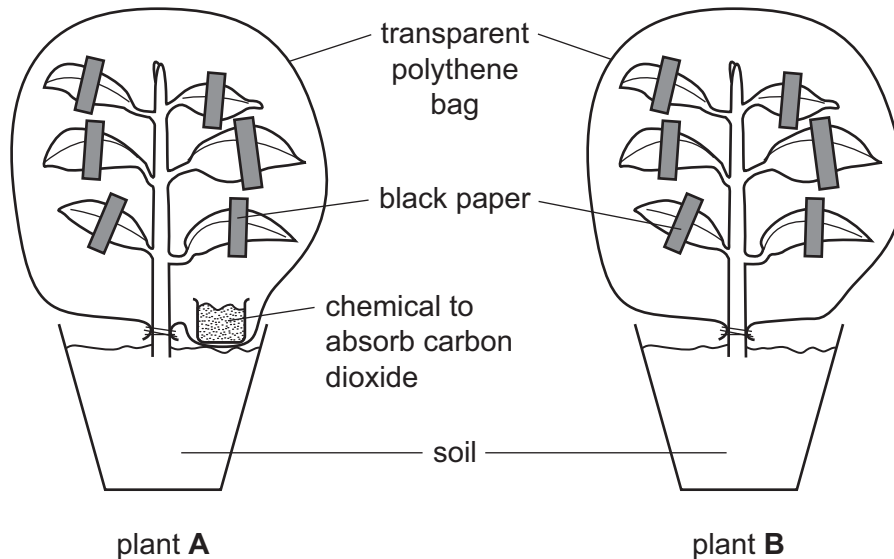
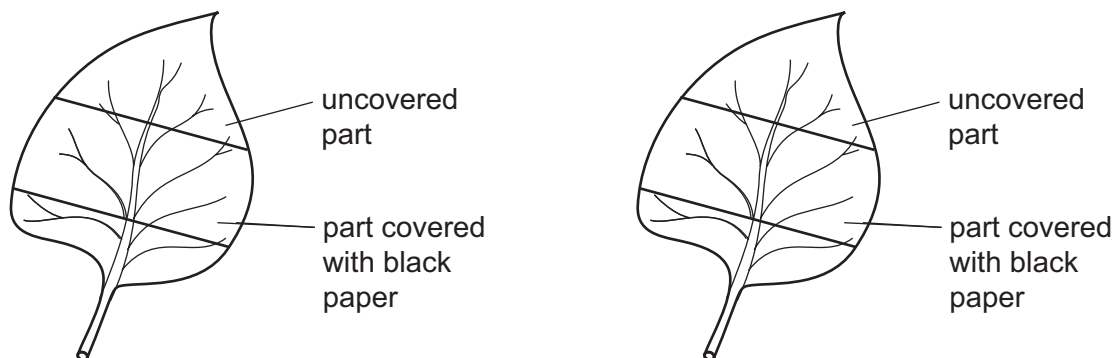

Fig. 1.1

One leaf was removed from each plant, and labelled drawings of the two leaves were made as shown in Fig. 1.2.



leaf from plant **A** with chemical
that absorbs carbon dioxide

leaf from plant **B** without chemical
that absorbs carbon dioxide

Fig. 1.2

Both leaves were then tested for starch.

- The black paper was removed from each leaf.
- The leaves were placed in hot water for two minutes.
- The leaves were removed from the hot water, and placed in a test-tube of hot alcohol for five minutes.
- The leaves were dipped briefly back into the hot water.
- The leaves were spread out on a white tile, and covered with iodine solution.

(a) On Fig. 1.2, on page 2, label the different areas of each leaf to show the colours that you would expect to see after each leaf had been treated with iodine solution. [3]

(b) In the starch test, explain the reasons for

(i) placing the leaf in the hot water at the beginning,

.....
..... [1]

(ii) placing the leaf in hot alcohol.

.....
..... [1]

(c) (i) The purpose of the experiment with the black paper was to see if light is needed for photosynthesis. However, another student criticised this experiment, saying that the black paper might have prevented photosynthesis by preventing gas exchange.

Suggest a modification of the experiment that would overcome this criticism.

.....
..... [1]

(ii) Another modification of the experiment would be to use just one plant, and enclose different part-covered leaves on this plant with and without the chemical that absorbs carbon dioxide.

Explain why this might be considered to be a better experiment.

.....
..... [1]

(d) Describe an experiment that you could do to show that chlorophyll in a leaf is needed for photosynthesis.

.....
.....
.....
.....
.....
..... [3]

2 In this experiment a student is investigating the period of a simple pendulum.

The *period* is the time for one complete oscillation of the pendulum.

The experiment is set up with the point of support 55.0 cm from the bench as in Fig. 2.1.

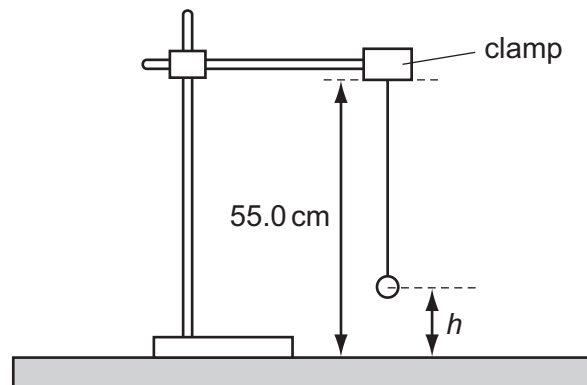

Fig. 2.1

- (a) The student adjusts the height, h , of the bob so that it is 10.0 cm above the bench. He gently starts the bob oscillating and starts the stopwatch. He counts 20 complete oscillations, stops the stopwatch and records the time in Table 2.1.

Table 2.1

height, h /cm	time for 20 oscillations/s	time, T for one oscillation/s	T^2/s^2
10.0	26	1.30	1.69
20.0	23	1.15	1.32
25.0			
30.0	19	0.95	0.90
40.0			

- (i) He alters the height, h , of the bob so that it is 20.0 cm above the bench. He times 20 complete oscillations and records it in Table 2.1. He repeats the experiment at several different heights, h .

Read the stopwatches in Fig. 2.2 and record the times for the 20 complete oscillations, in the appropriate spaces in Table 2.1. [2]

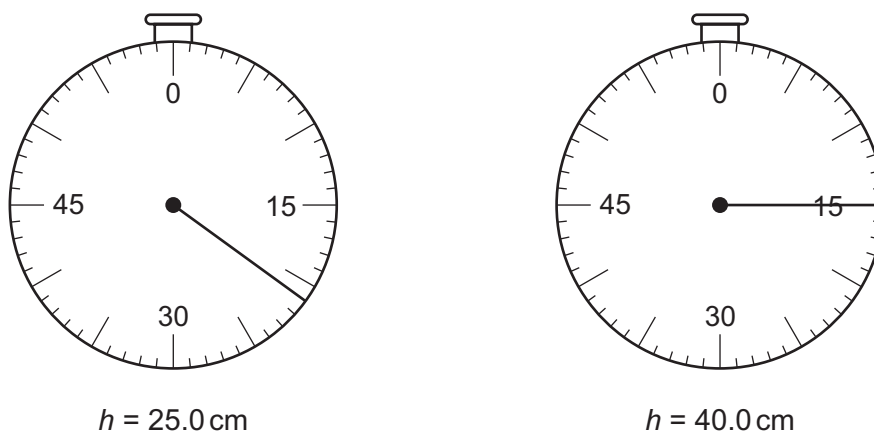
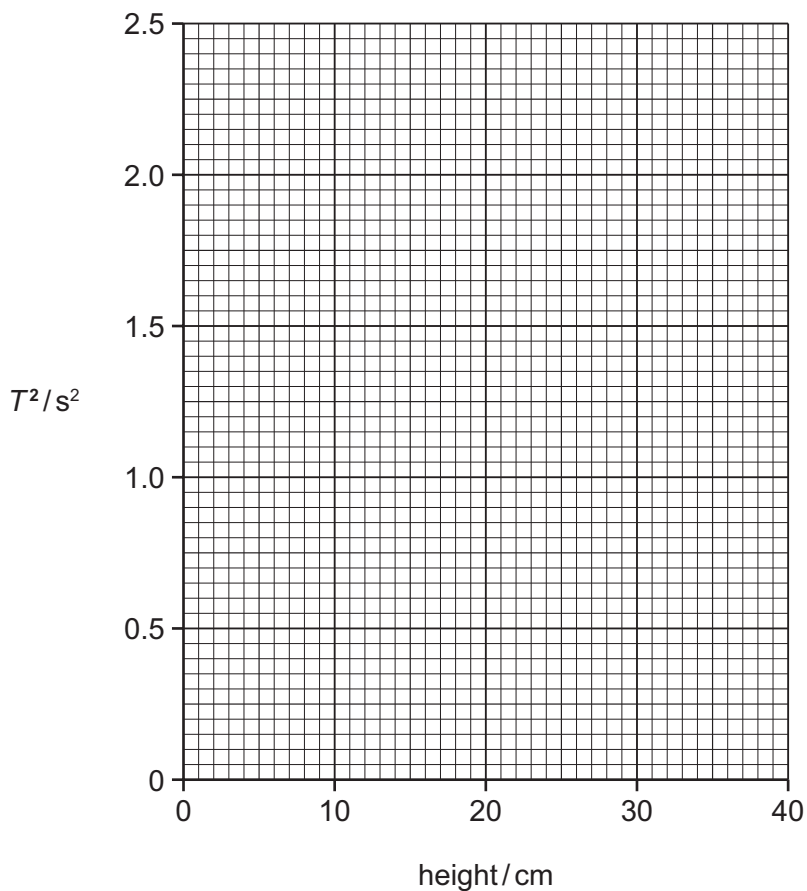

Fig. 2.2

- (ii) Using the results for 20 oscillations, in Table 2.1, calculate the time taken for one oscillation, T , for each height, h , in (a)(i) and complete the third column in Table 2.1. [1]
- (iii) Calculate the values of T^2 for each value of h , in (a)(i) and record them in the final column of Table 2.1. [1]
- (b) (i) On the grid provided plot a graph of T^2 against height. Draw the best fit straight line. [2]



- (ii) Calculate the gradient of the line, showing on your graph how you do this.

For
Examiner's
Use

gradient = [2]

- (iii) Extend the line you have drawn until it cuts the vertical axis.

Read off the value of T^2 when the height, $h = 0$.

$T^2 = \dots\dots\dots$ s² [1]

- (iv) Calculate the height of the support of the bob above the bench by dividing the value of T^2 found in (b)(iii) by the gradient found in (b)(ii).

height = cm [1]

- 3 A student carries out five tests on each of the solutions sodium hydroxide, aqueous ammonia, hydrochloric acid and sulfuric acid.

For
Examiner's
Use

Write in each blank box in Table 3.1 the observations you would expect to make. If you think nothing happens, write 'no change'.

There should be a statement in each blank box.

Table 3.1

		aqueous sodium hydroxide	aqueous ammonia	dilute hydrochloric acid	dilute sulfuric acid	
(a)	3 drops of Universal Indicator are added					[2]
(b)	an equal volume of silver nitrate solution is added	brown precipitate	no change		no change	[2]
(c)	an equal volume of barium chloride solution is added	no change	no change		white precipitate	[1]
(d)	copper sulfate solution is added slowly until the test-tube is half full			no change	no change	[3]
(e)	a 2 cm length of magnesium ribbon is added and any gas evolved tested with a lighted splint					[2]

- 4 A student carried out an experiment to study osmosis in dandelion stalks.

Osmosis is the movement of water from a region of high water concentration (a dilute solution) to a region of lower water concentration (a more concentrated solution).

She cut a piece of stalk from the dandelion and cut it lengthwise to produce 6 identical pieces. The dandelion plant and a piece of cut stalk are both shown in Fig. 4.1.

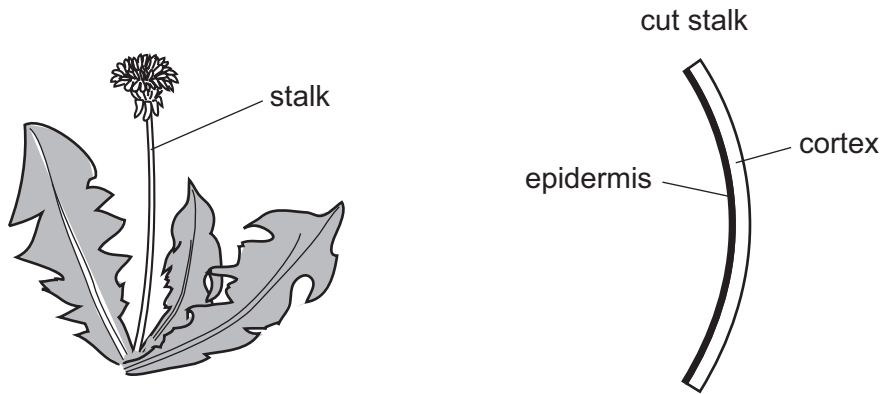

Fig. 4.1

The stalk curved after cutting because the epidermis cells are strong and covered with a thick cuticle. The cortex cells are packed very tightly and they expand a little when the stalk is cut.

No water enters or leaves the pieces of stalk through the epidermis.

- The student had six sucrose solutions of different concentrations. She immersed one strip of cut stalk into each solution.
- She left the strips for 20 minutes then removed them. The strips had changed shape.
- The results are shown in Fig. 4.2, on page 10.

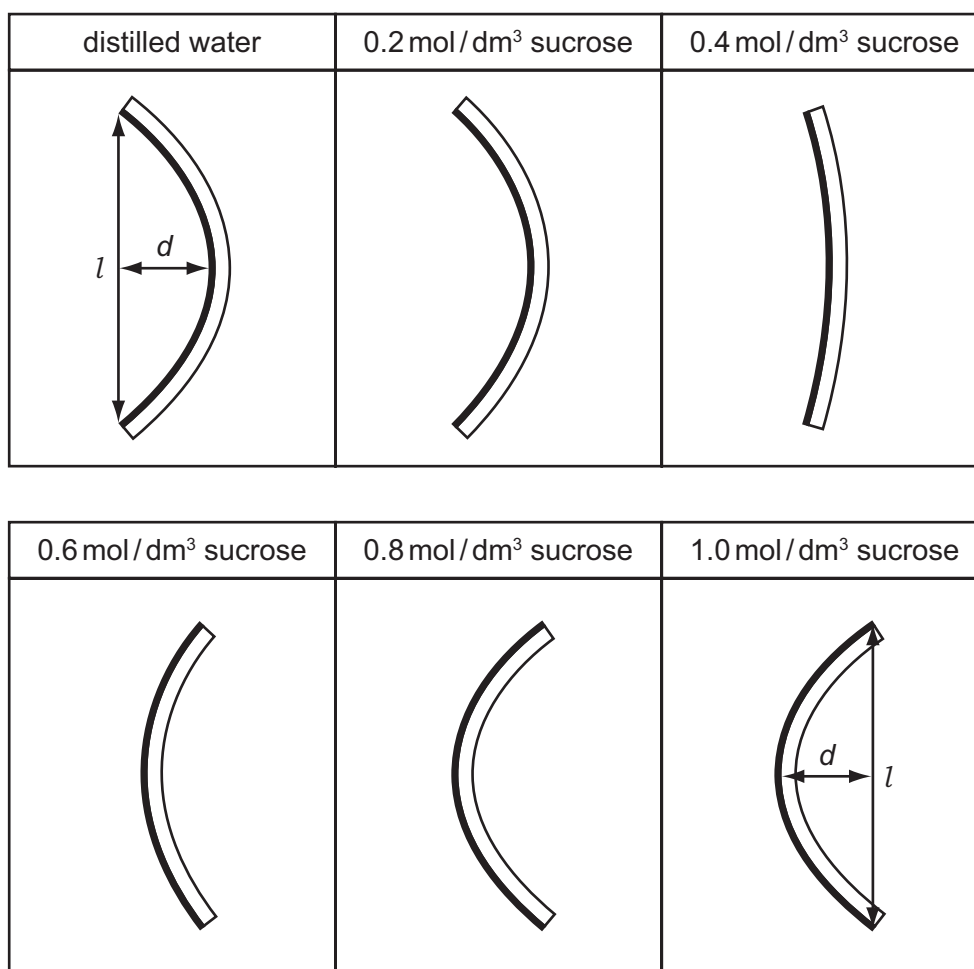

Fig. 4.2

The student measured how much each dandelion stalk had curved.

She drew a straight line, l , between both ends of the epidermis, and then measured the perpendicular distance, d , from the centre of the line to the **left edge** of the epidermis. The way she did this is shown on two diagrams in Fig. 4.2. She entered four of the readings in Table 4.1.

Table 4.1

concentration of sucrose solution in mol/dm ³	d /mm
0 (distilled water)	12
0.2	
0.4	3
0.6	-7
0.8	
1.0	-12

- (a) (i) Use the diagrams in Fig. 4.2 to measure, to the nearest millimetre, the values of d for solutions of concentrations of 0.2 and 0.8 mol/dm³.

Enter the measurements in Table 4.1. Note that when the stem curves to the left the value of d is positive. When the stem curves to the right the value is negative. [2]

- (ii) Plot the values of d against concentration of sucrose solution on the grid provided. Label the horizontal axis, showing the units. Draw a smooth curve. [3]

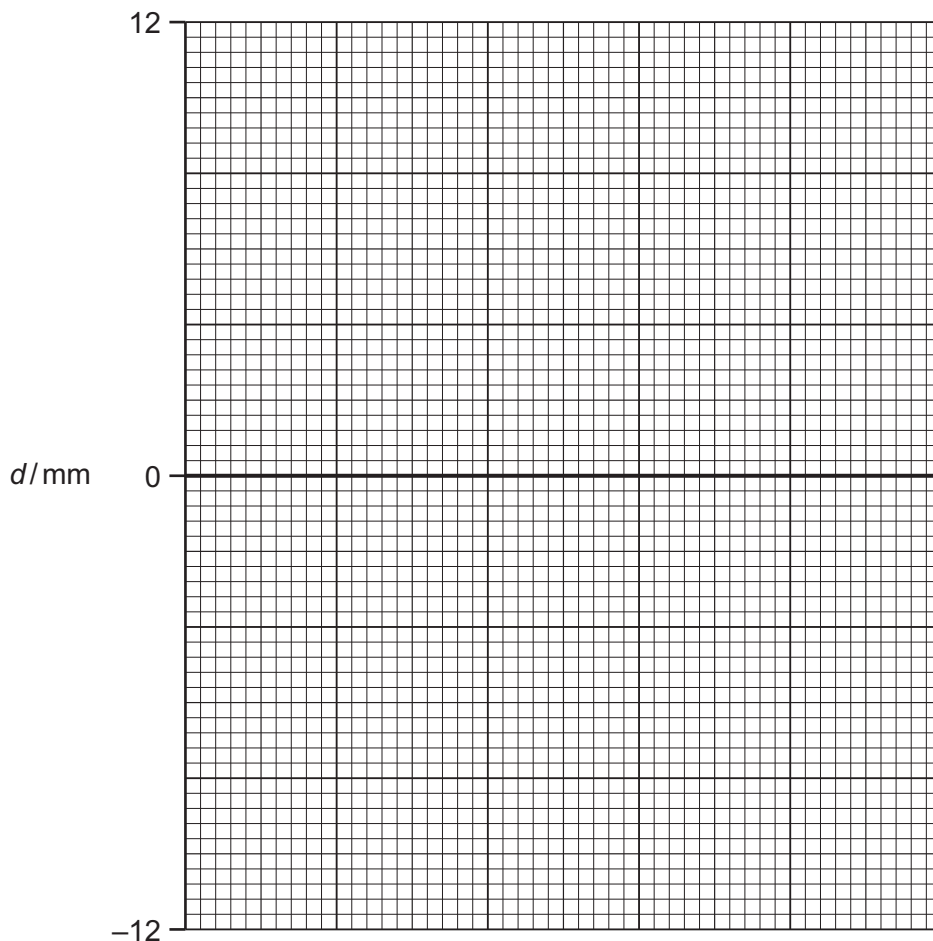

- (iii) Use Fig. 4.1, on page 9, to find the value d of the stalk before immersion.

$d =$ mm [1]

- (iv) Using your value from (a)(iii) and the graph, find the concentration of sucrose solution that would produce no change in shape of the cut stalk.

Show on the graph how you do this.

concentration of sucrose solution = mol/dm³ [2]

(b) In terms of osmosis explain what has happened to the cortex cells of the dandelion stalks during immersion in the 1.0 mol/dm^3 sucrose.

*For
Examiner's
Use*

.....

.....

..... [2]

Please turn over for Question 5.

- 5 (a) A student is copper plating a metal key by the electrolysis of aqueous copper chloride. He uses the following apparatus:

battery made up of three cells,
 switch,
 lamp,
 large beaker of aqueous copper chloride,
 copper electrode,
 metal key,
 sufficient leads and connectors.

- (i) Using a ruler where necessary, draw a circuit diagram to show how he should set up the apparatus.

[2]

- (ii) The teacher said that if the electrolysis was allowed to continue for a long time the copper electrode would disappear.

The student decides to find out how long it would take.

He takes a new copper electrode. He measures its mass as 20.05g and records it in Table 5.1.

Table 5.1

time/hours	0	1	2	3	4
mass/g	20.05	17.42			8.91

He closes the switch. After 1 hour he opens the switch, and quickly removes, dries and weighs the electrode. He records the new mass in Table 5.1. He replaces the electrode in the circuit and closes the switch. He repeats the process after 2, 3, and 4 hours.

Use Fig. 5.1 to read the mass of the electrode after 2 and 3 hours.

Record the masses in Table 5.1.

[2]

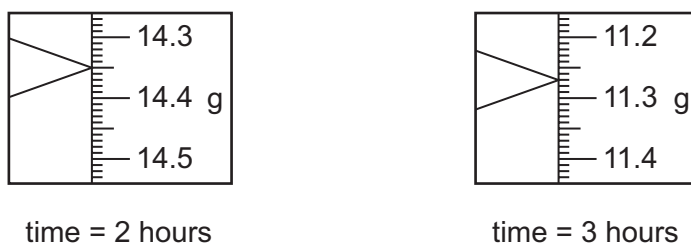
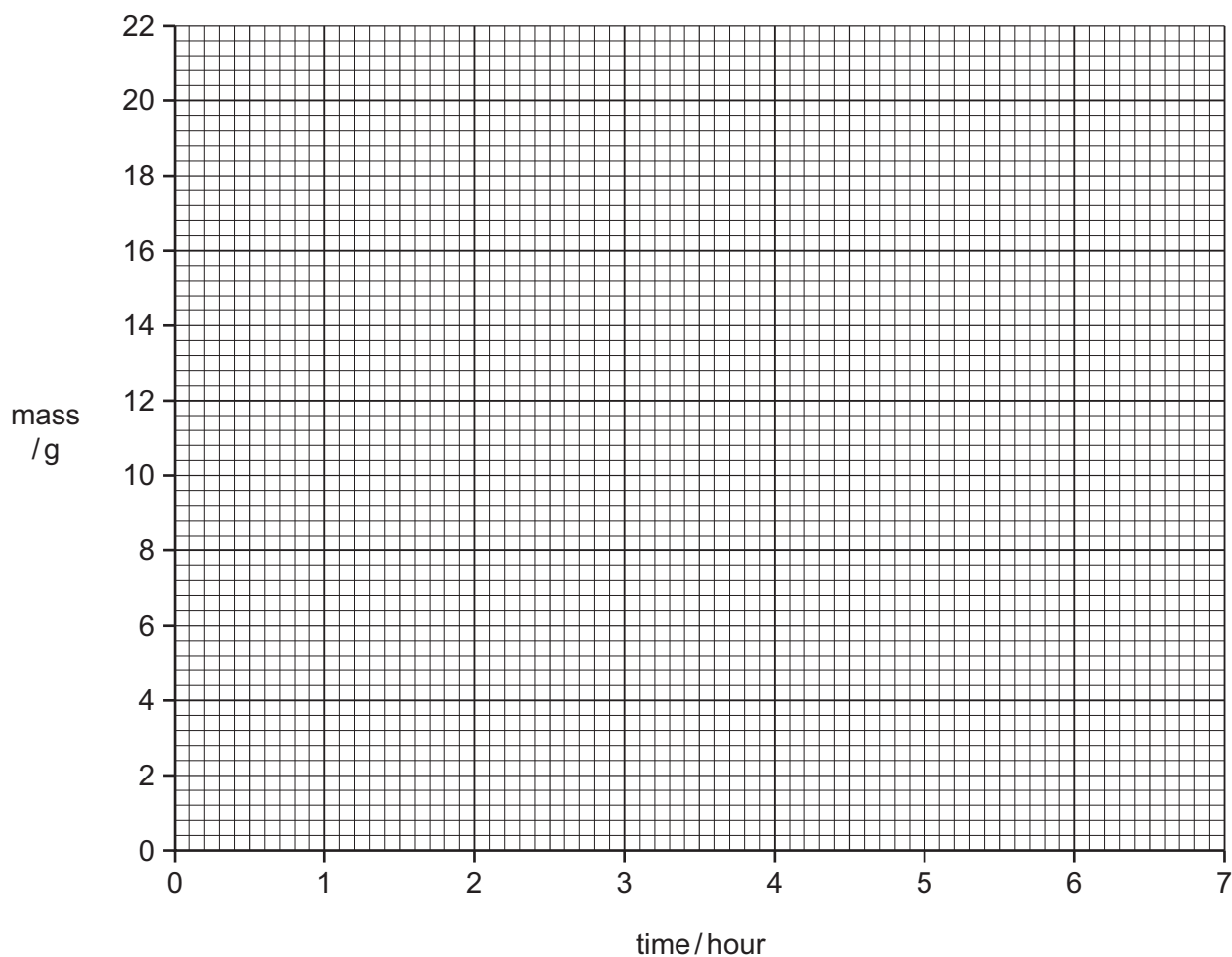

Fig. 5.1

For
Examiner's
Use

- (iii) On the grid plot a graph of mass/g against time/hour. Draw the best fit straight line. [2]



- (iv) The student kept the experiment going overnight and the next morning found the electrode had disappeared completely.

Find how long it took to dissolve fully by continuing your graph to the x-axis and read off the time taken.

time taken to disappear completely =hours [1]

- (b) The student carries out a second electrolysis, this time using carbon electrodes and aqueous copper chloride.

Explain why the colour of the copper chloride solution changes during this experiment.

..... [1]

- (c) Explain why aqueous copper chloride conducts electricity but solid copper chloride does not.

.....
.....
..... [2]

*For
Examiner's
Use*

Please turn over for Question 6.

- 6 (a) Fig. 6.1 shows words and phrases about gas tests, cut from a page of a student's note book.

For
Examiner's
Use

Use a ruler to construct a table, showing each gas with its test and the positive result to identify it.

relights
oxygen
Limewater
glowing splint
white precipitate
hydrogen
lighted splint
pops
carbon dioxide

Fig. 6.1

[4]

(b) Carbon dioxide can be formed by adding an acid to a carbonate.

Name a suitable acid and carbonate for this reaction.

acid

carbonate

[1]

(c) In the space below draw the apparatus you would use to carry out the experiment with your chosen acid and carbonate in order to measure the volume of gas evolved.

Label your diagram.

[4]

(d) Hydrogen gas can be produced by adding a metal to an acid.

Name a suitable metal that can be added to an acid to produce hydrogen safely.

..... [1]

BLANK PAGE

Permission to reproduce items where third-party owned material protected by copyright is included has been sought and cleared where possible. Every reasonable effort has been made by the publisher (UCLES) to trace copyright holders, but if any items requiring clearance have unwittingly been included, the publisher will be pleased to make amends at the earliest possible opportunity.

University of Cambridge International Examinations is part of the Cambridge Assessment Group. Cambridge Assessment is the brand name of University of Cambridge Local Examinations Syndicate (UCLES), which is itself a department of the University of Cambridge.