



Cambridge International Examinations
Cambridge International General Certificate of Secondary Education

PHYSICS

0625/13

Paper 1 Multiple Choice (Core)

October/November 2017

45 minutes

Additional Materials: Multiple Choice Answer Sheet
Soft clean eraser
Soft pencil (type B or HB recommended)



READ THESE INSTRUCTIONS FIRST

Write in soft pencil.

Do not use staples, paper clips, glue or correction fluid.

Write your name, Centre number and candidate number on the Answer Sheet in the spaces provided unless this has been done for you.

DO NOT WRITE IN ANY BARCODES.

There are **forty** questions on this paper. Answer **all** questions. For each question there are four possible answers **A, B, C** and **D**.

Choose the **one** you consider correct and record your choice in **soft pencil** on the separate Answer Sheet.

Read the instructions on the Answer Sheet very carefully.

Each correct answer will score one mark. A mark will not be deducted for a wrong answer.

Any rough working should be done in this booklet.

Electronic calculators may be used.

Take the weight of 1.0 kg to be 10 N (acceleration of free fall = 10 m/s^2).

The syllabus is approved for use in England, Wales and Northern Ireland as a Cambridge International Level 1/Level 2 Certificate.

This document consists of **19** printed pages and **1** blank page.

- 1 A measuring cylinder contains some water. A small metal block is slowly lowered into the water and is then removed.

Finally a piece of plastic is attached to the metal block and the block is again slowly lowered into the water.

The diagrams show the measuring cylinder at each stage of this process.

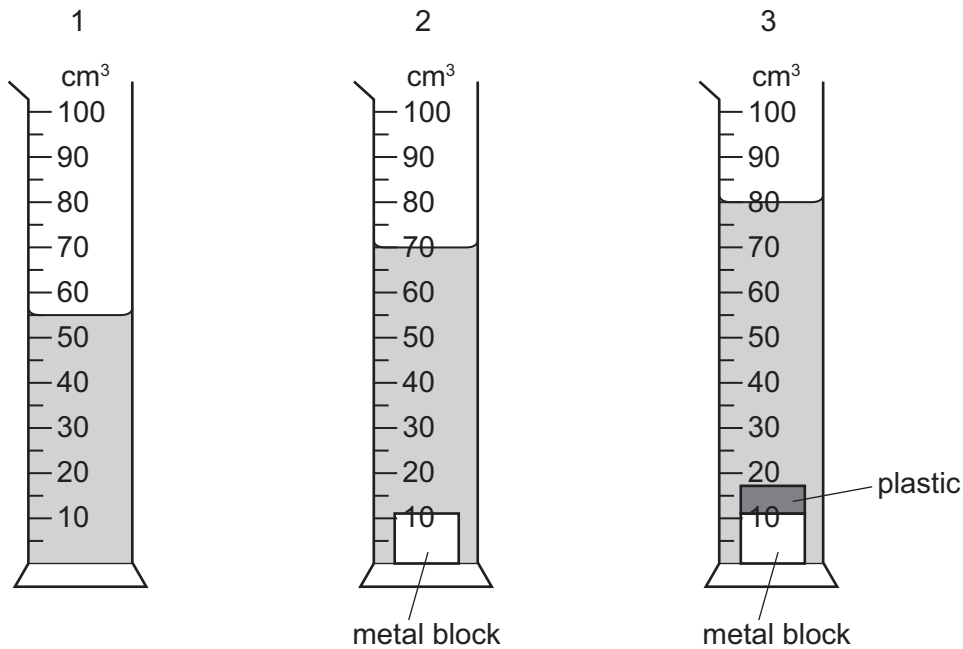

What is the volume of the piece of plastic?

- A** 10 cm^3 **B** 25 cm^3 **C** 70 cm^3 **D** 80 cm^3

- 2 A car accelerates from rest and travels a distance of 100 m in 10 seconds.

Which speed-time graph represents the motion of this car?

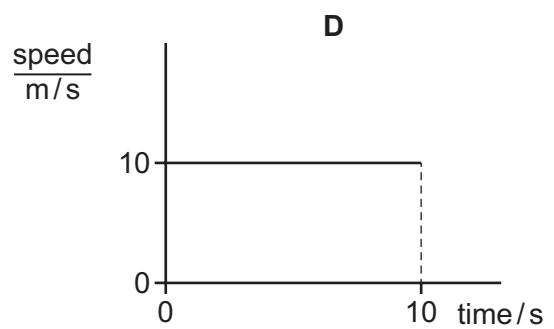
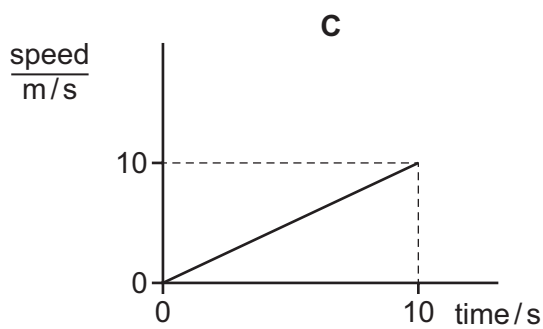
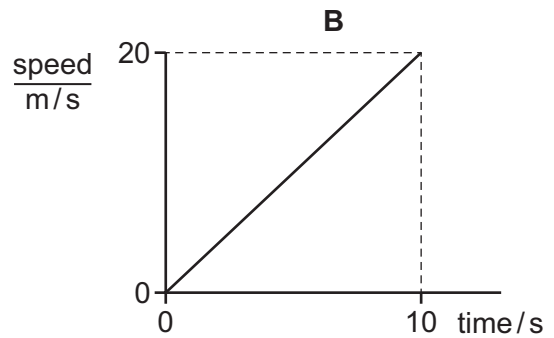
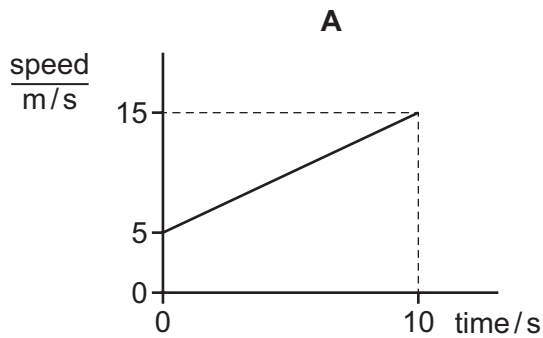

- 3 The diagram is the speed-time graph for a bicycle journey.

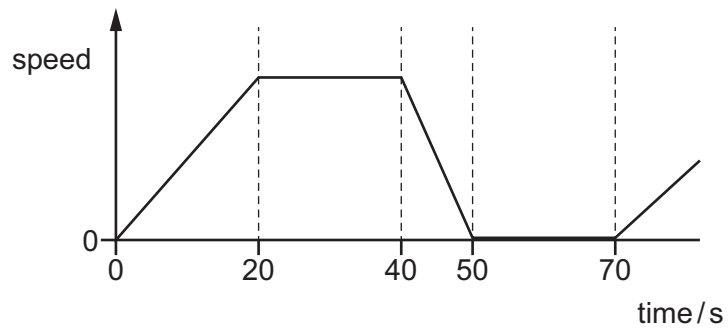

When is the bicycle moving at a constant speed?

- A** between 0 and 20 s
- B** between 20 s and 40 s
- C** between 40 s and 50 s
- D** between 50 s and 70 s

- 4 A spring is stretched by hanging a piece of metal from it.

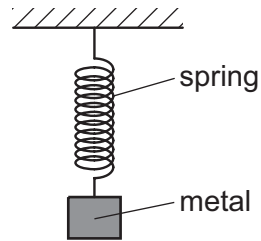

Which name is given to the force that stretches the spring?

- A friction
 - B mass
 - C pressure
 - D weight
- 5 The graph shows how weight varies with mass on planet P and on planet Q.

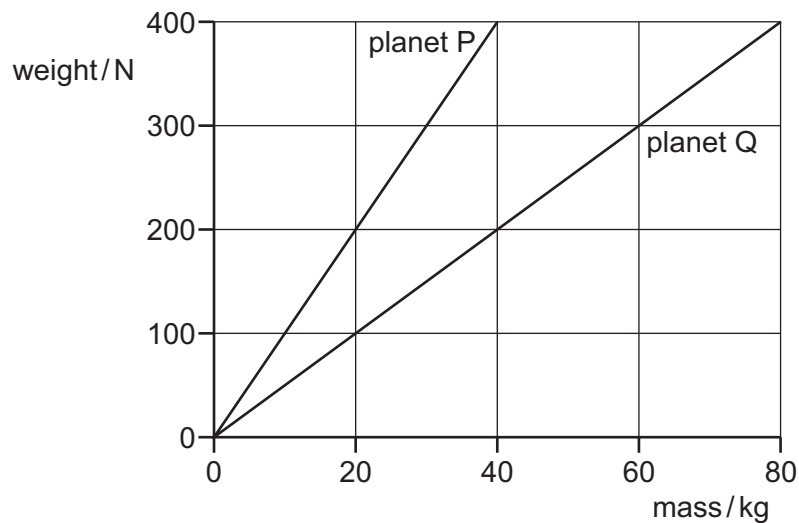

An object weighs 400 N on planet P. The object is taken to planet Q.

Which row is correct?

	mass of object on planet Q/kg	weight of object on planet Q/N
A	40	200
B	40	400
C	80	200
D	80	400

6 What is needed to determine the density of a regularly shaped block?

- A a balance and a beaker
- B a balance and a ruler
- C a measuring cylinder and a beaker
- D a measuring cylinder and a ruler

7 A cart experiences a forward force of 500 N.

The cart also experiences a backward force of 200 N.

There are no other forward or backward forces on the cart.

What is the resultant force on the cart?

- A 300 N backwards
- B 300 N forwards
- C 700 N backwards
- D 700 N forwards

8 The diagram shows a beam with a pivot, a load P at one end and a load Q at the other end.

The pivot can be moved left or right and the loads can be increased or decreased.

The weight of the beam can be ignored.

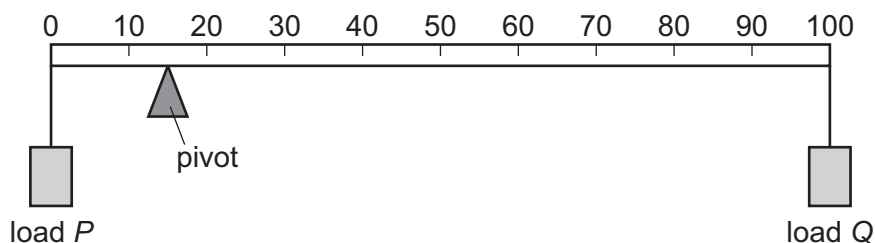

Which combination of pivot position and loads causes the beam to be in equilibrium?

	pivot position / cm	load P / N	load Q / N
A	30	6.0	4.0
B	40	6.0	4.0
C	50	5.0	9.0
D	60	3.0	9.0

- 9 The lamp in the diagram is not very stable and falls over easily.

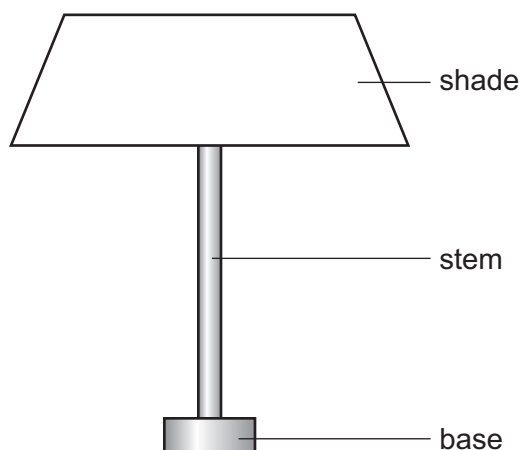

Which row shows changes that would definitely make the lamp more stable?

	base	centre of gravity
A	narrower	higher
B	narrower	lower
C	wider	higher
D	wider	lower

- 10 A toy car without a motor is moving at high speed along a track. The toy car follows a vertical loop as shown.

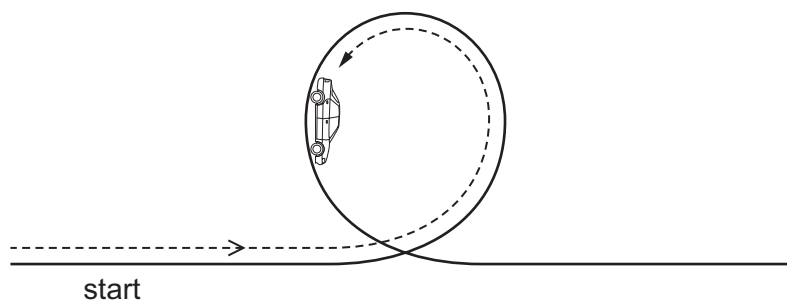

Which row describes the changes that are taking place in the kinetic energy and in the gravitational potential energy of the car in the position shown?

	kinetic energy	gravitational potential energy
A	decreasing	decreasing
B	decreasing	increasing
C	increasing	decreasing
D	increasing	increasing

11 A student runs up a flight of stairs.

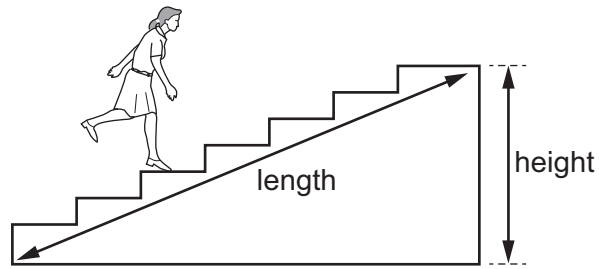

Which information is **not** needed to calculate the rate at which the student is doing work against gravity?

- A the height of the flight of stairs
- B the length of the flight of stairs
- C the time taken to run up the stairs
- D the weight of the student

12 The diagram shows a simple mercury barometer.

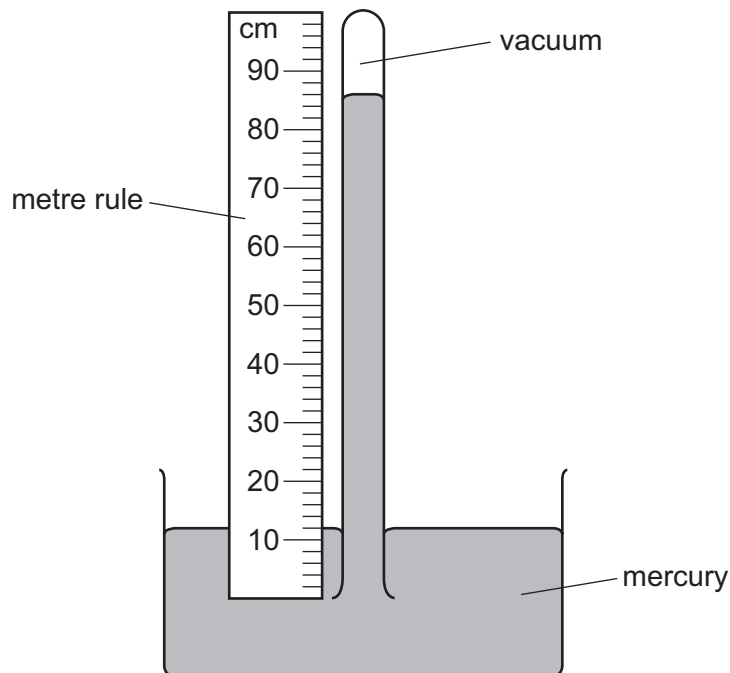

Which length is used to find the value of atmospheric pressure?

- A 12 cm
- B 74 cm
- C 86 cm
- D 100 cm

13 A polystyrene cube of mass 5.0 kg is placed on a horizontal surface. The pressure due to the cube is 89 N/m^2 .

What is the length of the sides of the cube?

- A 0.56 m
- B 0.75 m
- C 1.3 m
- D 1.8 m

14 A pollen grain in a beaker of still water is viewed through a microscope.

Which diagram shows the most likely movement of the pollen grain?

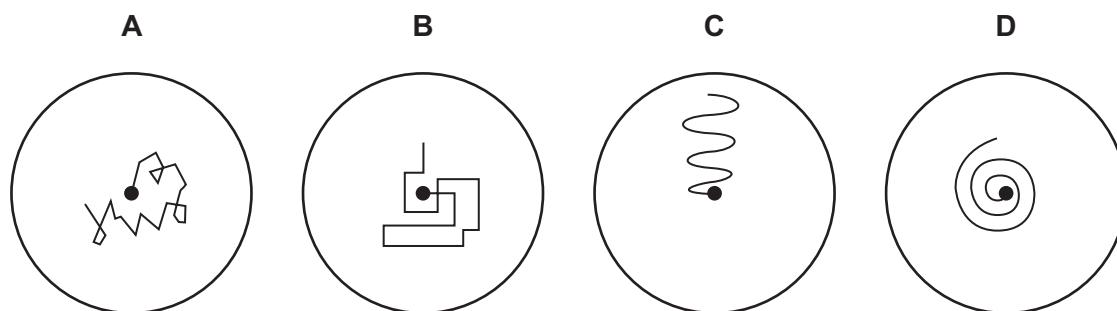

15 The diagram shows an air-filled rubber toy. A child sits on the toy and its volume decreases.

The temperature of the air in the toy does not change.

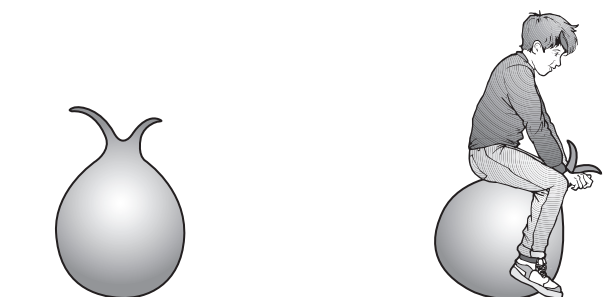

How does the air pressure in the toy change and why?

	pressure	reason
A	decreases	air molecules move more slowly
B	decreases	air molecules strike the rubber less frequently
C	increases	air molecules move more quickly
D	increases	air molecules strike the rubber more frequently

16 Which property **cannot** be used for the measurement of temperature?

- A** half-life of a radioactive isotope
- B** length of a solid metal bar
- C** pressure of a gas
- D** volume of a liquid

- 17 The diagram shows an electric heater being used to heat a beaker of water and an identical beaker containing oil. Both are heated for one minute.

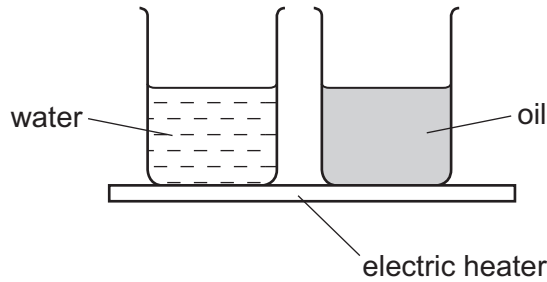

The temperature of the water and the temperature of the oil increase steadily. The increase in temperature of the oil is much greater than that of the water.

Why is this?

- A Oil has a higher boiling point than water.
 - B Oil has a lower boiling point than water.
 - C The oil has a larger thermal capacity than the water.
 - D The oil has a smaller thermal capacity than the water.
- 18 Why is the heating coil of a domestic immersion heater placed at the bottom of the tank?
- A Cold water is less dense than hot water and therefore sinks.
 - B Cold water is more dense than hot water and therefore rises.
 - C Hot water is less dense than cold water and therefore rises.
 - D Hot water is more dense than cold water and therefore sinks.
- 19 A plane wave in a shallow tank of water of uniform depth is incident normally on the small gap in a barrier.

What happens after the wave passes through the gap?

- A The frequency increases.
- B The speed decreases.
- C The wavelength decreases.
- D The wave spreads out.

20 The diagram represents plane wavefronts of a water wave about to strike a solid barrier.

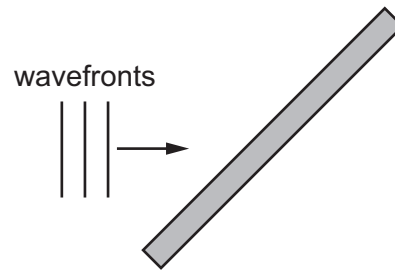

Which diagram shows the position of the wavefronts after reflection at the barrier?

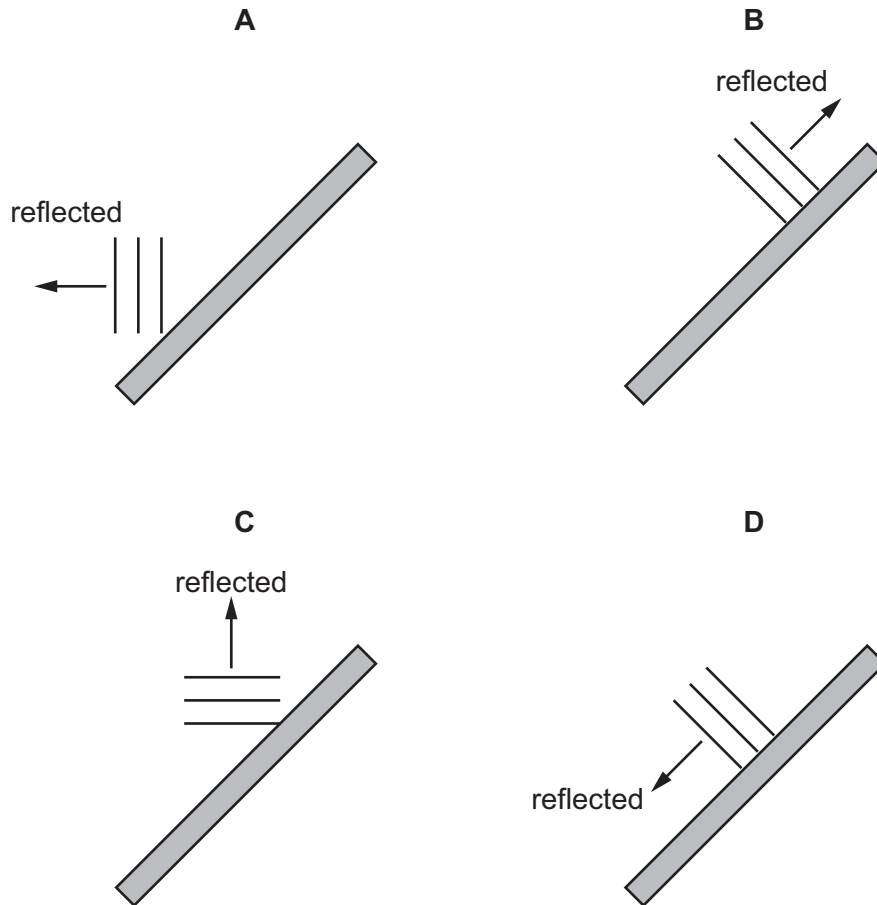

21 The diagram shows a ray of light in glass. The ray reaches a boundary with air.

One weak ray of light is missing from the diagram.

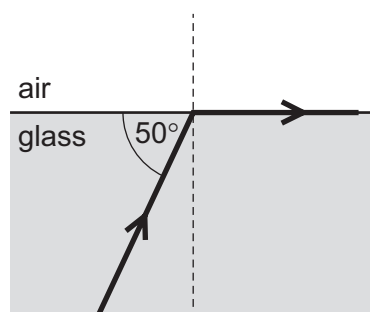

Which statement is correct?

- A At the boundary, the speed of the light will become less.
- B The critical angle for light at this boundary is 50° .
- C The diagram shows an example of diffraction of light.
- D The missing ray is a weak reflected ray.

22 Light enters a transparent block.

The light is refracted into the block and then strikes the top edge of the block at the critical angle.

Which diagram correctly shows the angle of refraction r and the critical angle c ?

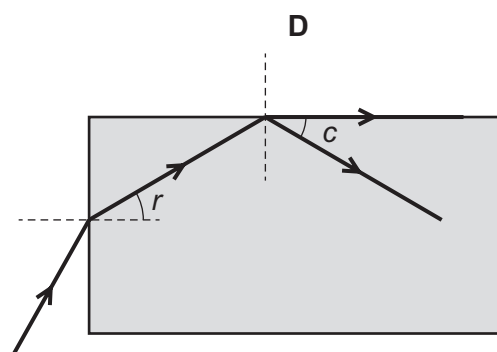
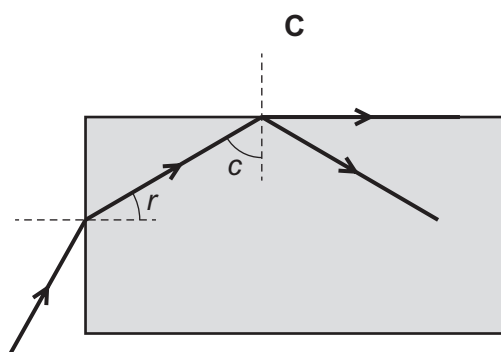
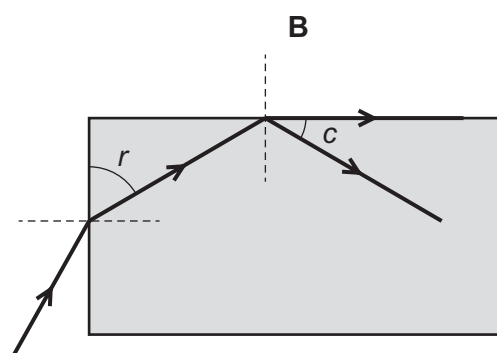
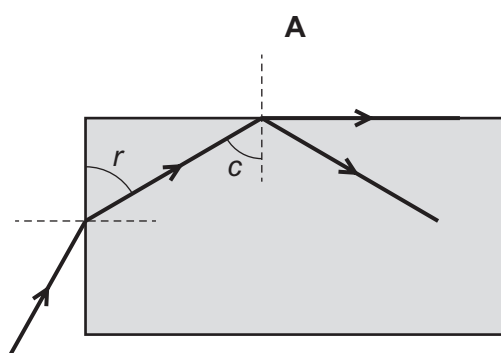

- 23 Which statement about radio waves is correct?
- A They are used in television remote controllers.
 - B They can be detected by the human eye.
 - C They travel as longitudinal waves.
 - D They have the same speed in a vacuum as ultraviolet waves.
- 24 Which types of thermal energy transfer are due to electromagnetic waves?
- A conduction and convection
 - B convection and radiation
 - C convection only
 - D radiation only
- 25 The speed of sound in air is 330 m/s.

The speed of ultraviolet waves in air is 300 000 000 m/s.

Which row gives a possible frequency and speed of an ultrasound wave in air?

	frequency / Hz	<u>speed</u> m/s
A	4000	330
B	4000	300 000 000
C	40 000	330
D	40 000	300 000 000

26 The diagram shows the Earth and its surroundings.

Through which labelled region can sound **not** be transmitted?

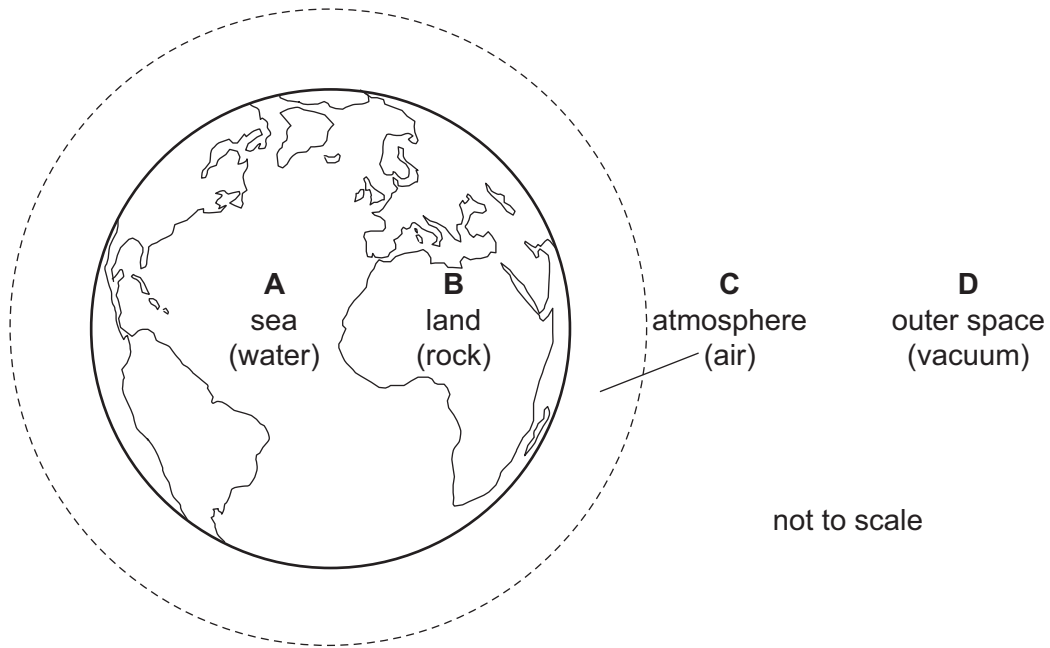

27 A train of steel nails and a train of iron nails hang from a strong magnet.

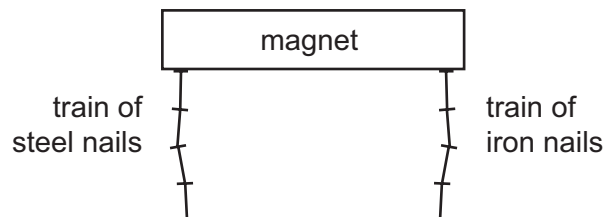

The trains are then carefully removed from the magnet.

What happens to the trains?

- A Both trains fall apart.
- B Both trains stay together.
- C Only the train of iron nails falls apart.
- D Only the train of steel nails falls apart.

28 The diagram shows an electromagnet.

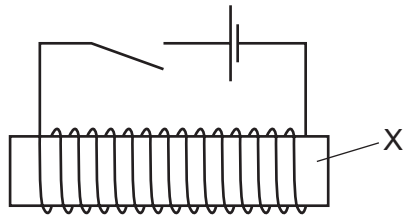

Which material is part X made from?

- A copper
- B iron
- C steel
- D tin

29 In which unit is the electromotive force (e.m.f.) of a battery measured?

- A A
- B J
- C N
- D V

30 The diagram shows a circuit symbol for a component that can be used as an input transducer.



Which graph shows how the resistance of the component varies with its intended input variable?

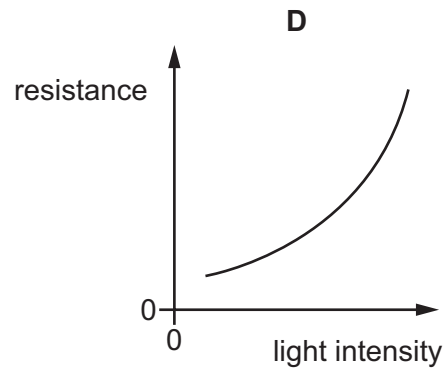
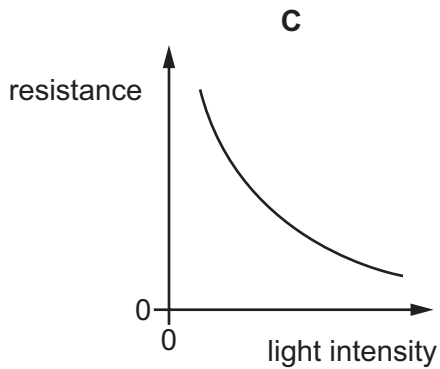
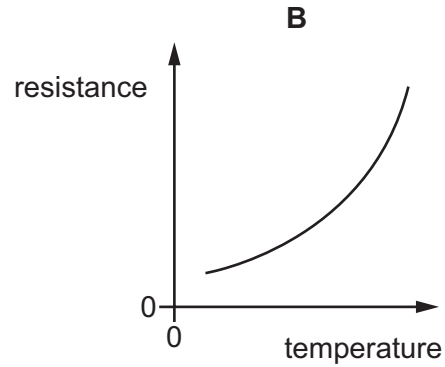
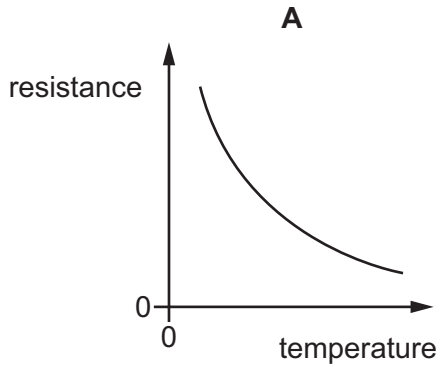

31 Which statement is **not** correct for two identical lamps connected in parallel?

- A** The potential difference across each lamp is half the supply voltage.
- B** The remaining lamp still operates when one lamp is removed.
- C** They can be switched on and off separately.
- D** They remain bright if another lamp is connected in parallel.

32 Only one of the ammeters in the circuit is showing an incorrect reading.

Which ammeter is showing the **incorrect** reading?

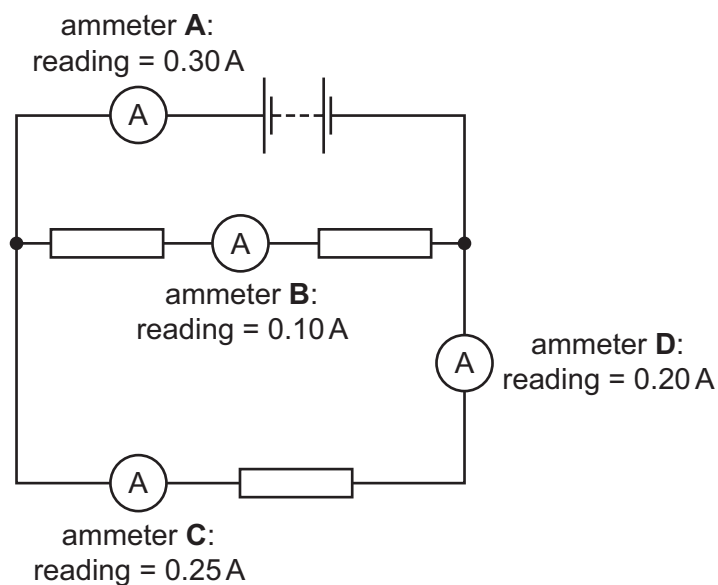

33 The diagram shows a circuit with a fixed resistor connected in series with a thermistor and an ammeter.

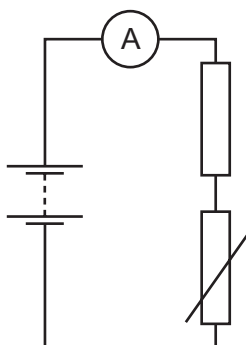

Which row shows how temperature change affects the resistance of the thermistor and the current in the circuit?

	temperature	resistance of thermistor	current in circuit
A	decreases	decreases	increases
B	decreases	increases	decreases
C	increases	decreases	decreases
D	increases	increases	increases

34 An appliance is connected to a mains supply. Its circuit also contains a switch and a fuse.

Which circuit shows the fuse in the correct position?

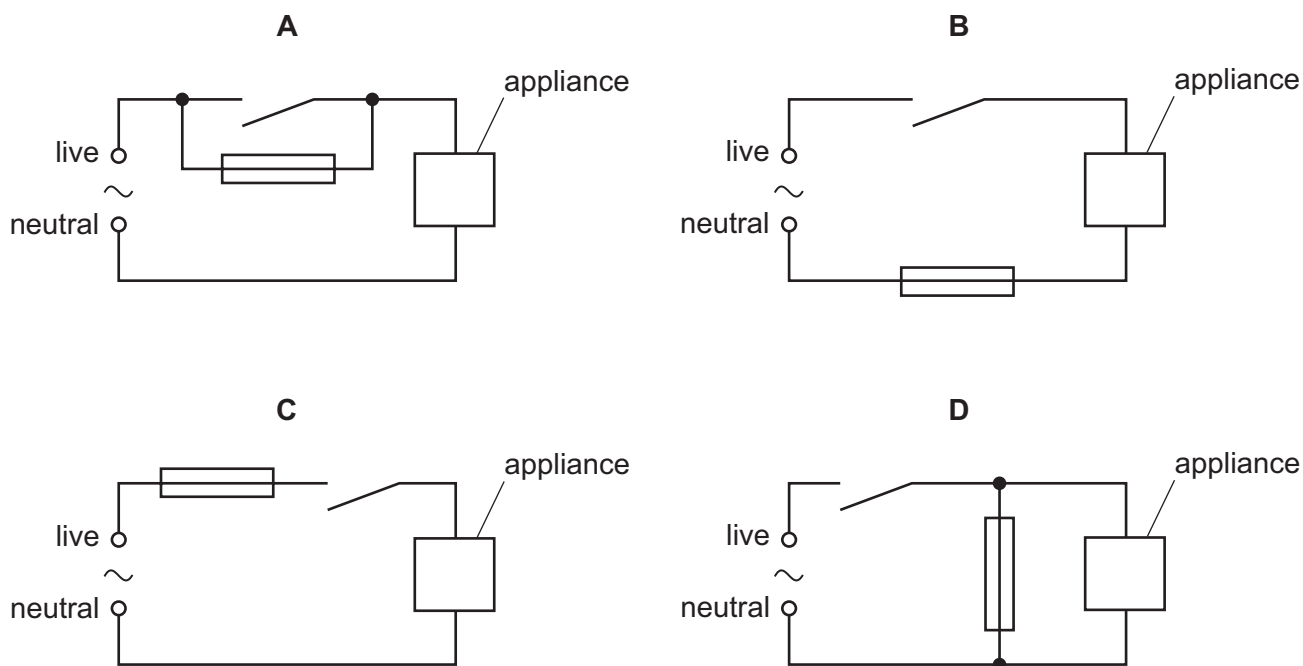

35 An electrical device requires a voltage of 5.0V to operate normally. The mains supply voltage is 250 V.

Which row shows a transformer that provides output voltage that enables the device to operate normally when connected to the mains supply?

	number of turns on the primary coil	number of turns on the secondary coil
A	500	2500
B	500	25 000
C	2500	500
D	25 000	500

36 A straight current-carrying wire has a magnetic field around it.

Which diagram best shows the magnetic field pattern around the wire?

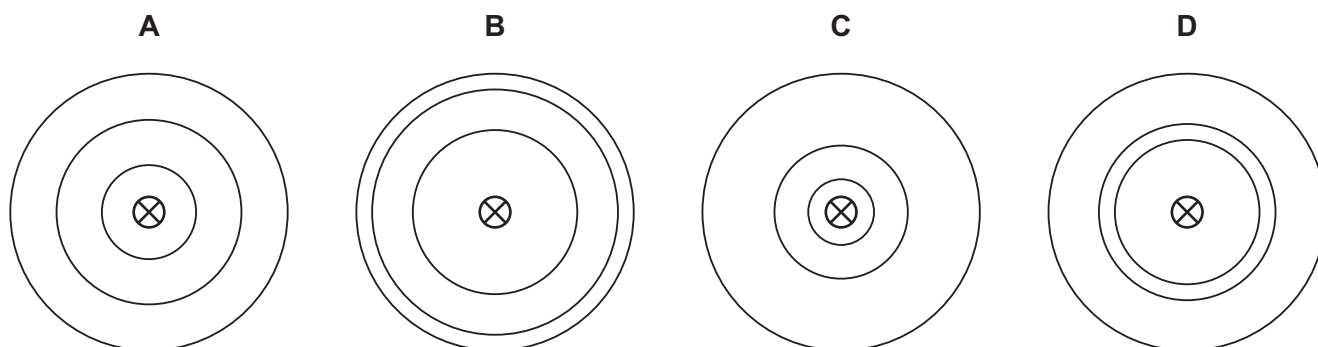

37 Which row states the charge on an electron and states whether electrons are located inside the nucleus of an atom?

	charge	located inside the nucleus
A	negative	no
B	negative	yes
C	positive	no
D	positive	yes

38 The element sodium, symbol Na, has a proton number of 11.

Which is a possible symbol for a sodium nuclide?

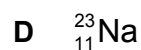
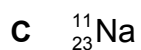
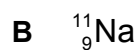
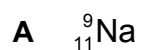

39 A radioactive source emits three types of radiation R, S and T.

The diagram shows an experiment set up to study the penetrating properties of R, S and T.

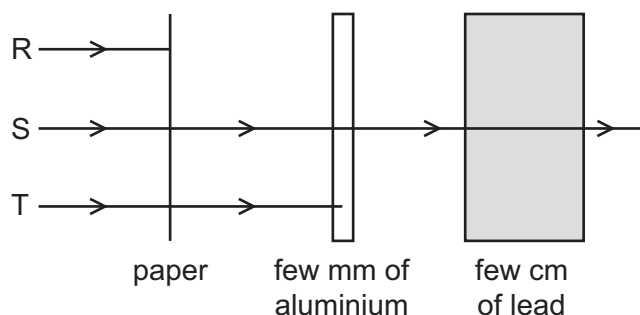

Which types of radiation are R, S and T?

	R	S	T
A	α -particles	β -particles	γ -rays
B	α -particles	γ -rays	β -particles
C	β -particles	α -particles	γ -rays
D	γ -rays	β -particles	α -particles

40 Radioactive iodine-131 emits β -particles and has a half-life of 8 days. It decays to produce xenon-131.

Which statement about this decay is correct?

- A** After 8 days no more β -particles are emitted.
- B** After 8 days the number of xenon-131 atoms has halved.
- C** After 16 days the iodine-131 has decayed completely.
- D** After 16 days the number of iodine-131 atoms has reduced to one quarter.

BLANK PAGE

Permission to reproduce items where third-party owned material protected by copyright is included has been sought and cleared where possible. Every reasonable effort has been made by the publisher (UCLES) to trace copyright holders, but if any items requiring clearance have unwittingly been included, the publisher will be pleased to make amends at the earliest possible opportunity.

To avoid the issue of disclosure of answer-related information to candidates, all copyright acknowledgements are reproduced online in the Cambridge International Examinations Copyright Acknowledgements Booklet. This is produced for each series of examinations and is freely available to download at www.cie.org.uk after the live examination series.

Cambridge International Examinations is part of the Cambridge Assessment Group. Cambridge Assessment is the brand name of University of Cambridge Local Examinations Syndicate (UCLES), which is itself a department of the University of Cambridge.