



**Cambridge International Examinations**  
Cambridge International General Certificate of Secondary Education

**PHYSICS**

**0625/11**

Paper 1 Multiple Choice (Core)

**October/November 2016**

**45 minutes**

Additional Materials: Multiple Choice Answer Sheet  
Soft clean eraser  
Soft pencil (type B or HB recommended)

\* 8 9 1 2 0 6 3 4 7 1 \*

**READ THESE INSTRUCTIONS FIRST**

Write in soft pencil.

Do not use staples, paper clips, glue or correction fluid.

Write your name, Centre number and candidate number on the Answer Sheet in the spaces provided unless this has been done for you.

**DO NOT WRITE IN ANY BARCODES.**

There are **forty** questions on this paper. Answer **all** questions. For each question there are four possible answers **A, B, C** and **D**.

Choose the **one** you consider correct and record your choice in **soft pencil** on the separate Answer Sheet.

**Read the instructions on the Answer Sheet very carefully.**

Each correct answer will score one mark. A mark will not be deducted for a wrong answer.

Any rough working should be done in this booklet.

Electronic calculators may be used.

Take the weight of 1.0 kg to be 10 N (acceleration of free fall =  $10 \text{ m/s}^2$ ).

The syllabus is approved for use in England, Wales and Northern Ireland as a Cambridge International Level 1/Level 2 Certificate.

This document consists of **17** printed pages and **3** blank pages.

- 1 A student has a can of oil.

Which quantity can be measured using only a measuring cylinder?

- A density of the oil
- B mass of the oil
- C volume of the oil
- D weight of the oil

- 2 The graph shows how the distance travelled by a vehicle changes with time.

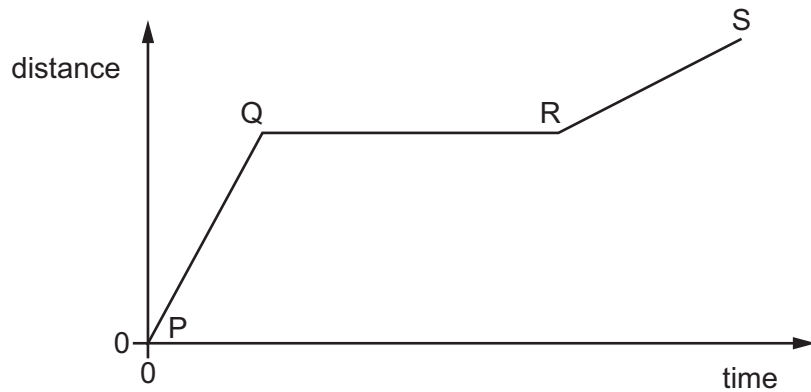

Which row describes the speed of the vehicle in each section of the graph?

|          | P to Q     | Q to R   | R to S     |
|----------|------------|----------|------------|
| <b>A</b> | constant   | zero     | constant   |
| <b>B</b> | constant   | zero     | decreasing |
| <b>C</b> | increasing | constant | decreasing |
| <b>D</b> | increasing | zero     | constant   |

- 3 A stone falls freely from the top of a cliff. Air resistance may be ignored.

Which graph shows how the acceleration of the stone varies with time as it falls?

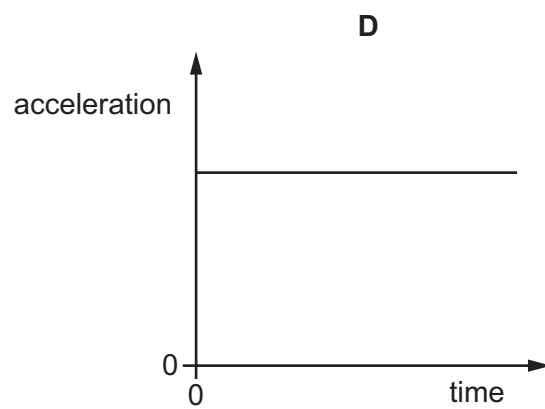
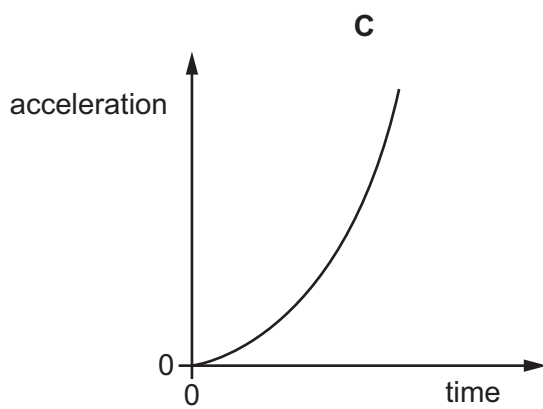
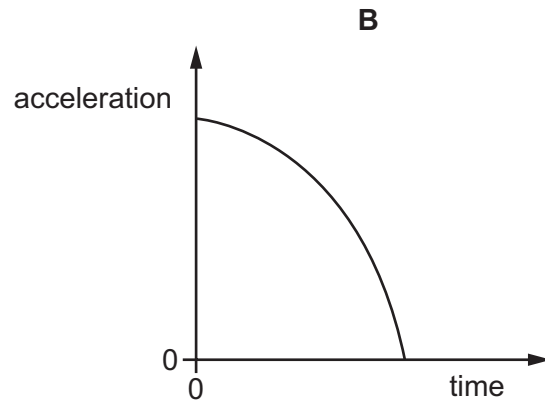
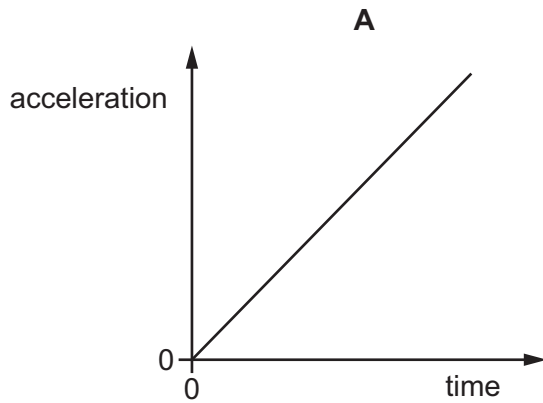

- 4 What name is given to the gravitational force of the Earth on an object?

- A** density
- B** mass
- C** volume
- D** weight

- 5 The diagrams show an empty rectangular box, and the same box filled with liquid.

The box has a mass of 60 g when empty. When filled with liquid, the total mass of the box and the liquid is 300 g.

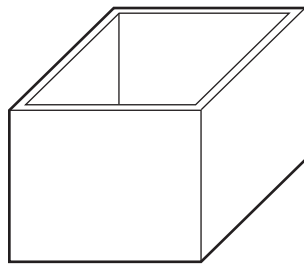

empty box  
60 g

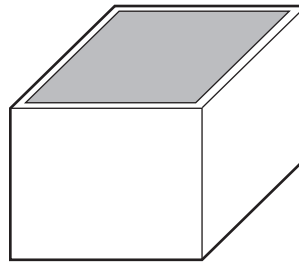

box filled with liquid  
300 g

The density of the liquid is  $1.2 \text{ g/cm}^3$ .

What is the volume of the liquid in the box?

- A  $50 \text{ cm}^3$       B  $200 \text{ cm}^3$       C  $250 \text{ cm}^3$       D  $300 \text{ cm}^3$
- 6 The diagrams show four identical objects. Each object is acted on by only the forces shown.

Which diagram shows an object in equilibrium?

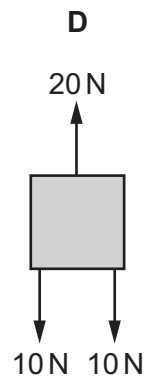
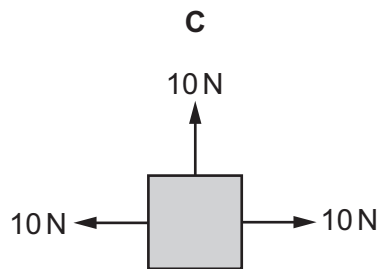
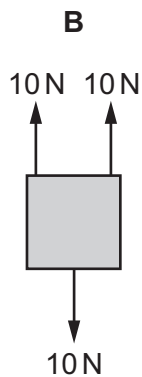
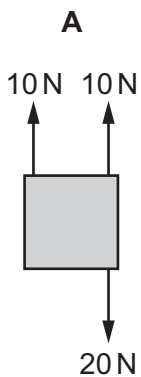

- 7 A student investigates a steel spring. He measures the length of the spring, then he hangs different weights from the spring. He measures the length of the spring for each different weight.

The table shows his results.

| weight / N | length of spring / mm |
|------------|-----------------------|
| 0.0        | 108                   |
| 2.0        | 116                   |
| 4.0        | 124                   |
| 6.0        | 132                   |

A weight of 3.0 N is hung from the spring.

What is the extension of the spring?

- A** 4 mm      **B** 12 mm      **C** 40 mm      **D** 120 mm
- 8 The diagram shows a plank balanced on a pivot. Three forces  $F$ ,  $P$  and  $Q$  act on the plank, as shown.

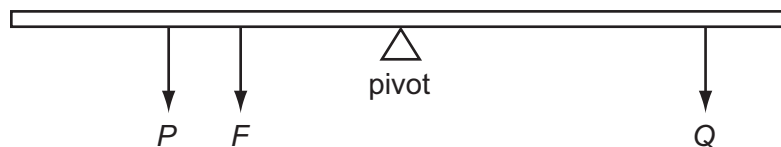

The force  $F$  is increased, but continues to act at the same distance from the pivot. The plank is no longer balanced.

Which change could make the plank balance again?

- A** decrease  $Q$   
**B** increase  $P$   
**C** move  $P$  further from the pivot  
**D** move  $Q$  further from the pivot
- 9 Which energy transfer takes place when petrol is burned?
- A** chemical to internal energy of surroundings (heat)  
**B** chemical to nuclear  
**C** gravitational potential to internal energy of surroundings (heat)  
**D** kinetic to chemical

- 10 The box contains the names of eight different energy resources.

|               |            |       |       |
|---------------|------------|-------|-------|
| natural gas   | geothermal | solar | waves |
| hydroelectric | oil        | wind  | coal  |

How many of these energy resources are renewable?

- A** 3                      **B** 4                      **C** 5                      **D** 6
- 11 A child runs up a set of stairs four times. The time taken for each run is recorded.
- Which time is measured when the child's useful power is greatest?
- A** 10 s                      **B** 20 s                      **C** 30 s                      **D** 40 s
- 12 The diagrams show the actual sizes of the heels of four different shoes, as seen from underneath the shoe.

Which heel is **most** likely to cause damage to wooden floors?

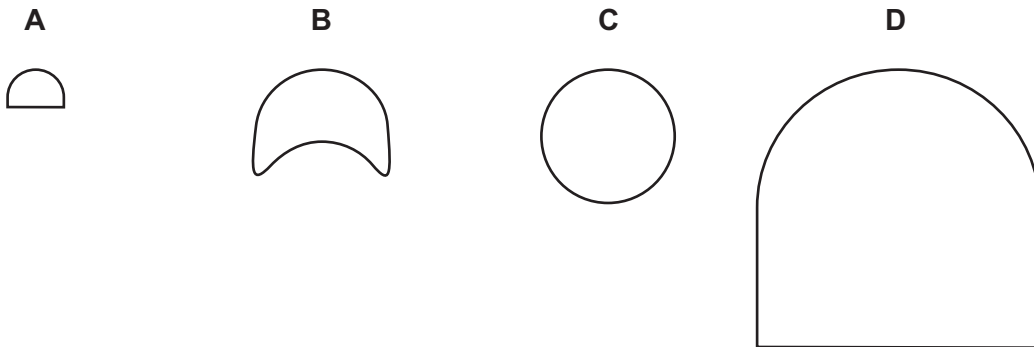

- 13 The diagram shows an instrument used to measure gas pressure.

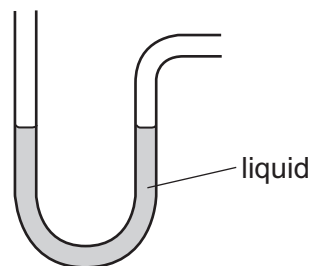

What is the instrument called?

- A** ammeter  
**B** barometer  
**C** manometer  
**D** thermometer

- 14 Smoke particles in air are illuminated by a beam of light. The particles are viewed through a microscope. They are seen to move in a random zig-zag way.

What causes this movement?

- A convection currents in the air
- B impacts of fast-moving air molecules
- C the energy of the beam of light
- D vibrations of the atoms in the smoke particles

- 15 When a liquid evaporates, some of its molecules escape from the surface and the temperature of the liquid changes.

Which row describes the escaping molecules and the change in temperature of the liquid?

|   | escaping molecules | temperature of the liquid |
|---|--------------------|---------------------------|
| A | less energetic     | goes down                 |
| B | less energetic     | goes up                   |
| C | more energetic     | goes down                 |
| D | more energetic     | goes up                   |

- 16 A piece of melting ice at  $0^{\circ}\text{C}$  and a beaker of boiling water are both in a laboratory. The laboratory is at  $20^{\circ}\text{C}$ .

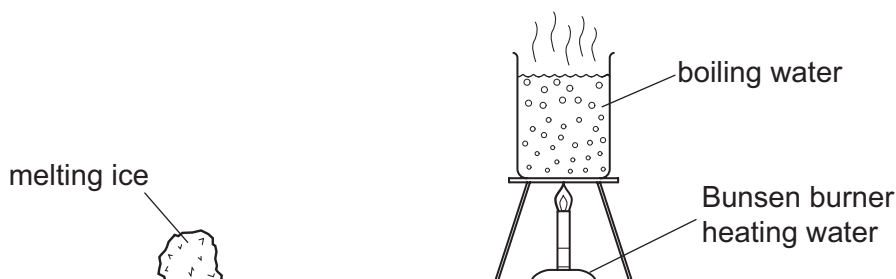

What is happening to the temperature of the melting ice and what is happening to the temperature of the boiling water?

|   | temperature of melting ice | temperature of boiling water |
|---|----------------------------|------------------------------|
| A | constant                   | constant                     |
| B | constant                   | increasing                   |
| C | increasing                 | constant                     |
| D | increasing                 | increasing                   |

- 17 Changes in which physical property **cannot** be used for temperature measurement?
- A decay rate of a radioactive source
  - B electrical resistance of a solid
  - C pressure of a gas
  - D volume of a liquid
- 18 Which statement about infra-red radiation is correct?
- A A black surface is a poor absorber of infra-red radiation.
  - B A dull surface is a better emitter of infra-red radiation than a shiny surface.
  - C A shiny surface is a better absorber of infra-red radiation than a dull surface.
  - D A white surface is a poor reflector of infra-red radiation.
- 19 A pan is made for heating water on a stove.



From which type of materials should the pan and its handle be made?

|          | material for pan       | material for handle    |
|----------|------------------------|------------------------|
| <b>A</b> | good thermal conductor | good thermal conductor |
| <b>B</b> | good thermal conductor | poor thermal conductor |
| <b>C</b> | poor thermal conductor | good thermal conductor |
| <b>D</b> | poor thermal conductor | poor thermal conductor |



**20** A toy boat floats on water in a tank. The boat is initially stationary.

A stone is thrown into the tank, which causes a transverse water wave to move across the surface.

The diagram shows the view from above the tank.

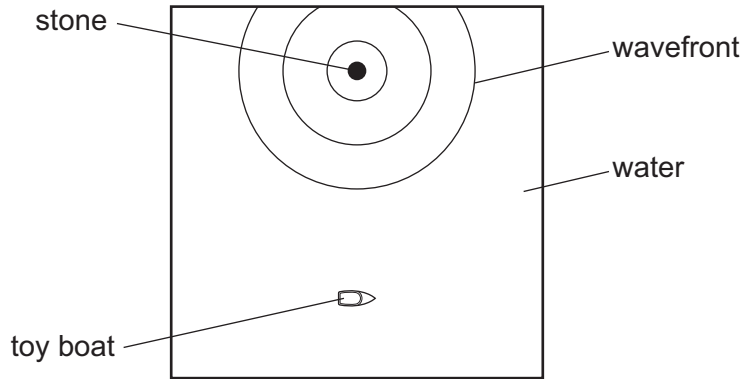

How does the boat behave as the wave passes it?

- A** It moves steadily away from where the stone hit the water.
- B** It moves steadily towards where the stone hit the water.
- C** It stays the same distance from where the stone hit the water, and vibrates from side to side.
- D** It stays the same distance from where the stone hit the water, and vibrates up and down.

**21** Below are four statements about the diffraction of a wave on the surface of water.

Which statement is correct?

- A** Diffraction involves a change in the speed of the wave.
- B** Diffraction involves a change in the wavelength of the wave.
- C** When a wave passes through a gap, its direction changes.
- D** When a wave passes through a gap, its frequency changes.

22 A child wears a T-shirt with the letter 'F' written on it.



The child stands in front of a vertical plane mirror.

What does the child see?

A



B



C

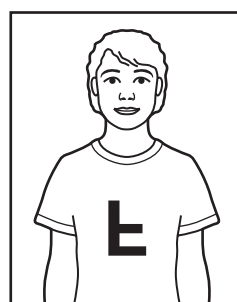

D

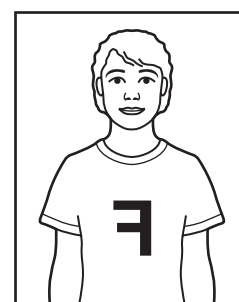

23 When white light passes through a glass prism, it disperses as shown in the diagram.

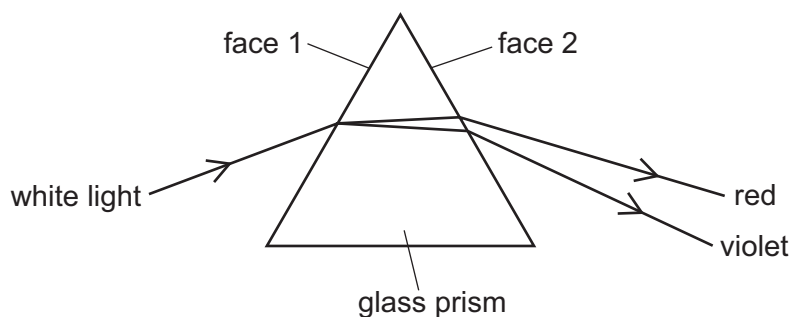

Which row compares the refraction of violet light with the refraction of red light at the faces 1 and 2 of the prism?

|          | face 1               | face 2               |
|----------|----------------------|----------------------|
| <b>A</b> | violet refracts less | violet refracts less |
| <b>B</b> | violet refracts less | violet refracts more |
| <b>C</b> | violet refracts more | violet refracts less |
| <b>D</b> | violet refracts more | violet refracts more |

- 24 Radiation from which part of the electromagnetic spectrum is used in the remote controller for a television?
- A infra-red waves
  - B microwaves
  - C radio waves
  - D ultraviolet waves

- 25 A girl notices that, when she shouts into a cave, she hears an echo.

Which wave property causes the echo?

- A diffraction
  - B dispersion
  - C reflection
  - D refraction
- 26 The diagrams represent the displacement in four different sound waves. All the diagrams are drawn to the same scale.

Which diagram represents the sound with the highest pitch?

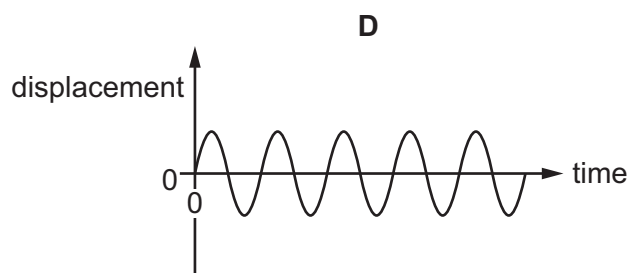
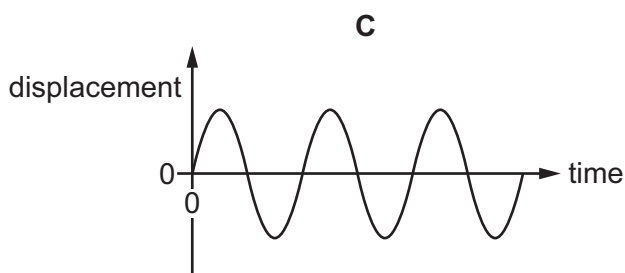
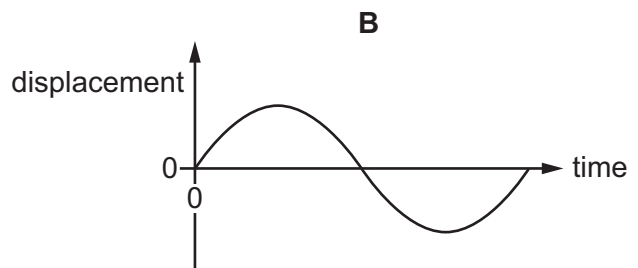
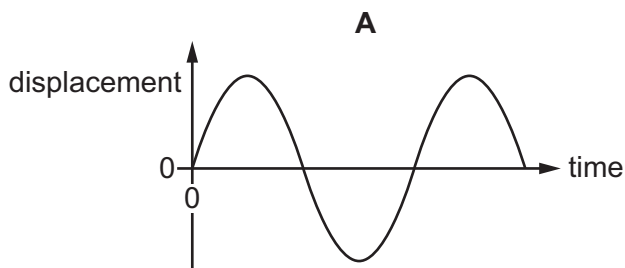

- 27 In two separate experiments, a magnet is brought near to an unmagnetised iron bar. This causes the bar to become magnetised.

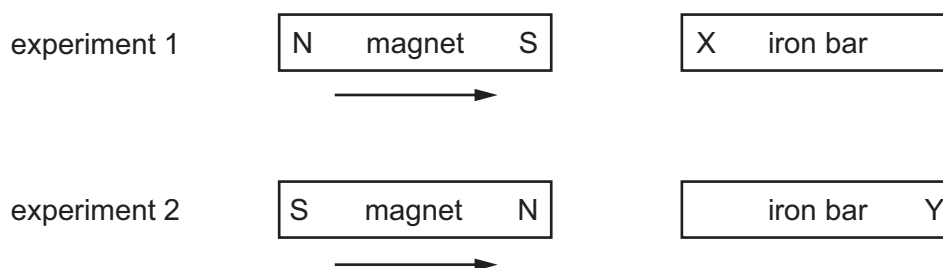

Which magnetic pole is induced at X and at Y?

|          | pole induced at X | pole induced at Y |
|----------|-------------------|-------------------|
| <b>A</b> | N                 | N                 |
| <b>B</b> | N                 | S                 |
| <b>C</b> | S                 | N                 |
| <b>D</b> | S                 | S                 |

- 28 A polythene rod is rubbed with a cloth. The rod becomes positively charged because of the movement of charged particles.

Which row gives the name of these charged particles, and the direction in which they move?

|          | charged particles | direction of movement |
|----------|-------------------|-----------------------|
| <b>A</b> | electrons         | from cloth to rod     |
| <b>B</b> | electrons         | from rod to cloth     |
| <b>C</b> | protons           | from cloth to rod     |
| <b>D</b> | protons           | from rod to cloth     |

29 The diagram shows a lamp in a circuit.

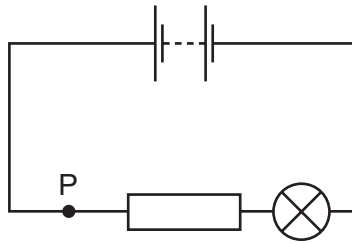

Which change to the circuit would increase the current in the lamp?

- A adding another resistor in parallel with the one in the circuit
  - B adding another resistor in series with the one in the circuit
  - C decreasing the electromotive force (e.m.f.) of the battery in the circuit
  - D moving the lamp to point P in the circuit
- 30 An ammeter and an  $18\ \Omega$  resistor are connected in series with a battery. The reading on the ammeter is  $0.50\ \text{A}$ .

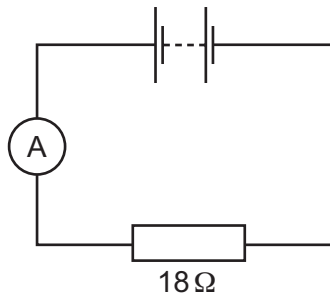

What is the electromotive force (e.m.f.) of the battery?

- A  $9.0\ \text{N}$
- B  $9.0\ \text{V}$
- C  $36\ \text{N}$
- D  $36\ \text{V}$

- 31 A source of constant electromotive force (e.m.f.) is connected across a thermistor.

There is an electric current in the thermistor.



The temperature of the thermistor is reduced.

Which row shows what happens to the resistance of the thermistor and what happens to the current?

|          | resistance     | current   |
|----------|----------------|-----------|
| <b>A</b> | increases      | decreases |
| <b>B</b> | increases      | increases |
| <b>C</b> | stays the same | decreases |
| <b>D</b> | stays the same | increases |

- 32 The diagram shows a circuit containing a battery, a resistor with high resistance, a switch and a lamp.

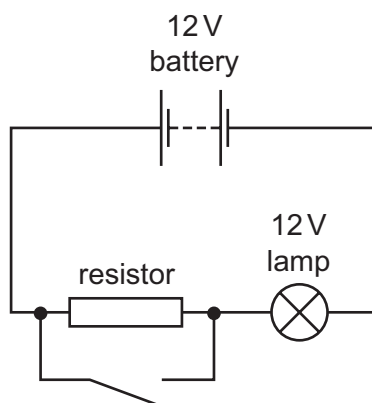

Initially the switch is open.

What happens to the lamp when the switch is closed?

- A** It glows more brightly.
- B** It glows less brightly.
- C** It goes out.
- D** Its brightness does not change.

- 33 The diagram shows a circuit containing two identical lamps and three ammeters.

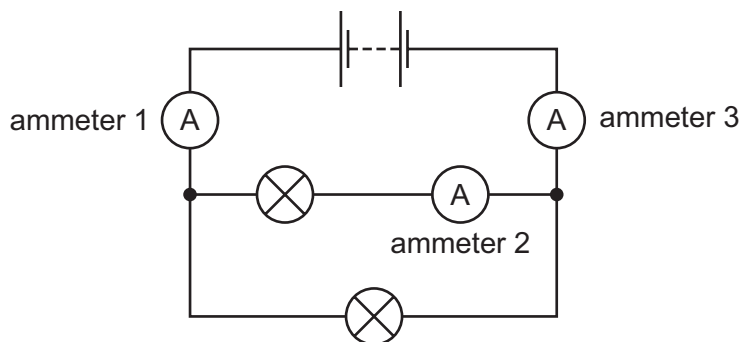

The current in ammeter 1 is 0.30 A.

Which row gives possible values for the currents in ammeters 2 and 3?

|          | ammeter 2<br>/A | ammeter 3<br>/A |
|----------|-----------------|-----------------|
| <b>A</b> | 0.15            | 0.00            |
| <b>B</b> | 0.15            | 0.30            |
| <b>C</b> | 0.30            | 0.00            |
| <b>D</b> | 0.30            | 0.30            |

- 34 Two electrical appliances are connected to the mains supply.

The cable connected to one appliance includes an earth wire.

The cable connected to the second appliance does **not** need an earth wire.

What is a reason for this difference?

- A** One appliance has a metal case, but the other appliance does not.
- B** One appliance is fitted with a fuse, but the other appliance is not.
- C** One appliance is fitted with a switch, but the other appliance is not.
- D** One appliance needs more current than the other appliance.

35 The diagram represents a transformer.

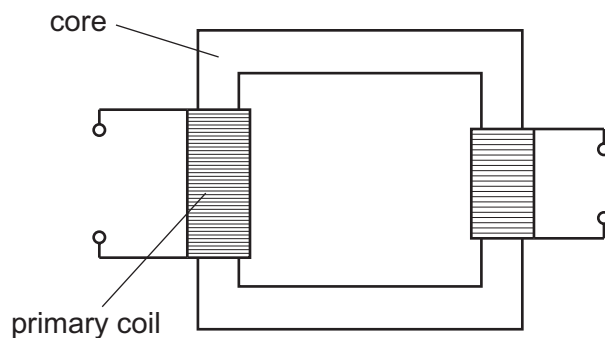

Which row shows materials suitable for making the core and the primary coil?

|          | core  | primary coil |
|----------|-------|--------------|
| <b>A</b> | iron  | copper       |
| <b>B</b> | iron  | plastic      |
| <b>C</b> | steel | copper       |
| <b>D</b> | steel | plastic      |

36 An electric current can produce a heating effect and a magnetic effect.

Which row shows the effect that a relay uses and one application of a relay?

|          | effect used by a relay | one application of a relay                            |
|----------|------------------------|---|
| <b>A</b> | heating effect         | allowing a small current to switch on a large current |
| <b>B</b> | heating effect         | changing the voltage of an a.c. supply                |
| <b>C</b> | magnetic effect        | allowing a small current to switch on a large current |
| <b>D</b> | magnetic effect        | changing the voltage of an a.c. supply                |

37 A nuclide of sodium can be represented by  ${}_{11}^{23}\text{Na}$ .

Which row gives the numbers of particles in a neutral sodium atom?

|          | number of electrons | number of protons | number of neutrons |
|----------|---------------------|-------------------|--------------------|
| <b>A</b> | 11                  | 11                | 12                 |
| <b>B</b> | 12                  | 11                | 23                 |
| <b>C</b> | 12                  | 12                | 11                 |
| <b>D</b> | 23                  | 23                | 11                 |



38 Radioactive materials may emit  $\alpha$ -particles or  $\beta$ -particles.

Which statement about the effect of these emissions is correct?

- A Both  $\alpha$ -particles and  $\beta$ -particles cause the nucleus to change into that of a different chemical element.
- B Neither  $\alpha$ -particles nor  $\beta$ -particles cause the nucleus to change into that of a different chemical element.
- C Only  $\alpha$ -particles cause the nucleus to change into that of a different chemical element.
- D Only  $\beta$ -particles cause the nucleus to change into that of a different chemical element.

39 Radioactive source S emits  $\alpha$ -particles,  $\beta$ -particles and  $\gamma$ -rays. A detector is placed 5 cm away from S. A thin sheet of paper is placed as shown in the diagram.

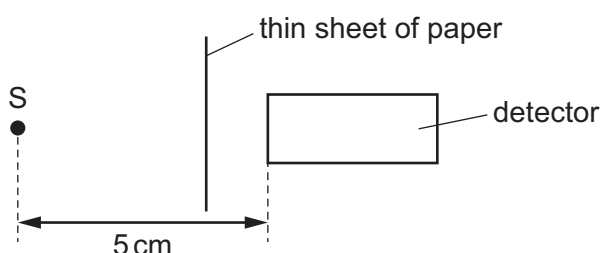

Which emissions from the source can be detected?

- A  $\alpha$ -particles and  $\beta$ -particles only
- B  $\alpha$ -particles and  $\gamma$ -rays only
- C  $\beta$ -particles and  $\gamma$ -rays only
- D  $\alpha$ -particles,  $\beta$ -particles and  $\gamma$ -rays

40 The half-life of a radioactive nuclide is 2.0 hours.

The decay rate of a sample of this nuclide is measured at 1.0 hour intervals. The table shows the measurements, with one value shown as X.

| time / hours | decay rate / decays / s |
|--------------|-------------------------|
| 0            | 240                     |
| 1.0          | 170                     |
| 2.0          | 120                     |
| 3.0          | 85                      |
| 4.0          | X                       |

What is the most likely value of X?

- A 15
- B 42
- C 50
- D 60





**BLANK PAGE**

---

Permission to reproduce items where third-party owned material protected by copyright is included has been sought and cleared where possible. Every reasonable effort has been made by the publisher (UCLES) to trace copyright holders, but if any items requiring clearance have unwittingly been included, the publisher will be pleased to make amends at the earliest possible opportunity.

To avoid the issue of disclosure of answer-related information to candidates, all copyright acknowledgements are reproduced online in the Cambridge International Examinations Copyright Acknowledgements Booklet. This is produced for each series of examinations and is freely available to download at [www.cie.org.uk](http://www.cie.org.uk) after the live examination series.

Cambridge International Examinations is part of the Cambridge Assessment Group. Cambridge Assessment is the brand name of University of Cambridge Local Examinations Syndicate (UCLES), which is itself a department of the University of Cambridge.