



Cambridge International Examinations
Cambridge International General Certificate of Secondary Education

PHYSICS

0625/13

Paper 1 Multiple Choice (Core)

October/November 2016

45 minutes

Additional Materials: Multiple Choice Answer Sheet
Soft clean eraser
Soft pencil (type B or HB recommended)

* 7 1 3 3 1 5 6 9 6 5 *

READ THESE INSTRUCTIONS FIRST

Write in soft pencil.

Do not use staples, paper clips, glue or correction fluid.

Write your name, Centre number and candidate number on the Answer Sheet in the spaces provided unless this has been done for you.

DO NOT WRITE IN ANY BARCODES.

There are **forty** questions on this paper. Answer **all** questions. For each question there are four possible answers **A, B, C** and **D**.

Choose the **one** you consider correct and record your choice in **soft pencil** on the separate Answer Sheet.

Read the instructions on the Answer Sheet very carefully.

Each correct answer will score one mark. A mark will not be deducted for a wrong answer.

Any rough working should be done in this booklet.

Electronic calculators may be used.

Take the weight of 1.0 kg to be 10 N (acceleration of free fall = 10 m/s^2).

The syllabus is approved for use in England, Wales and Northern Ireland as a Cambridge International Level 1/Level 2 Certificate.

This document consists of **19** printed pages and **1** blank page.

- 1 Diagram 1 shows a measuring cylinder containing some water.

Diagram 2 shows the same measuring cylinder after a piece of rock has been slowly submerged in the water.

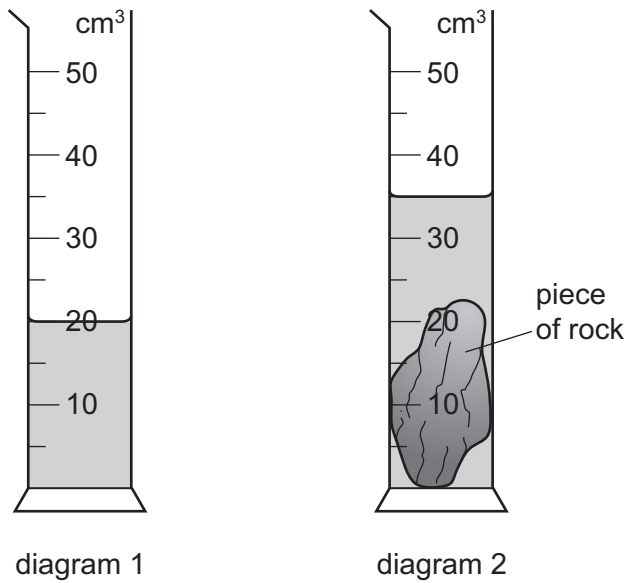

What is the volume of the piece of rock?

- A 15 cm³ B 20 cm³ C 23 cm³ D 35 cm³
- 2 The graph shows how the distance travelled by a vehicle changes with time.

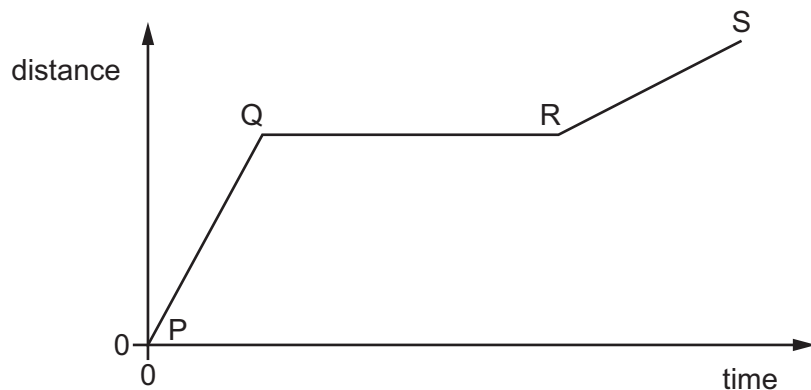

Which row describes the speed of the vehicle in each section of the graph?

	P to Q	Q to R	R to S
A	constant	zero	constant
B	constant	zero	decreasing
C	increasing	constant	decreasing
D	increasing	zero	constant

- 3 A stone falls freely from the top of a cliff. Air resistance may be ignored.

Which graph shows how the acceleration of the stone varies with time as it falls?

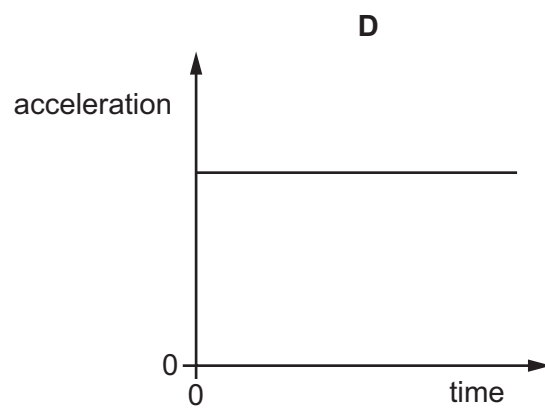
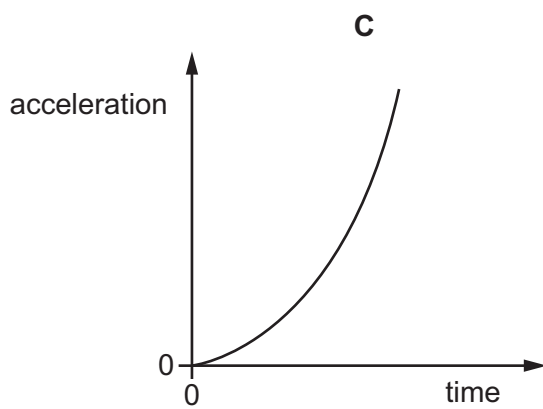
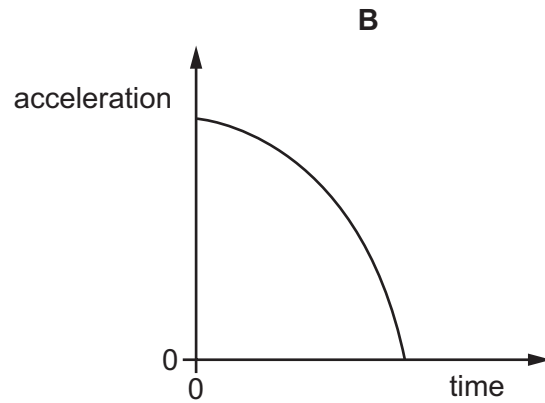
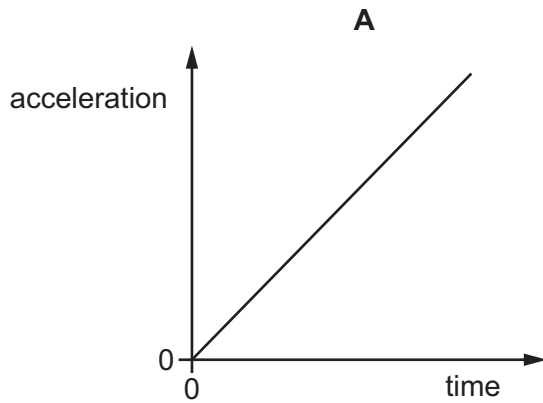

- 4 Which statement about mass or weight is **not** correct?

- A** Masses can be compared using a balance.
- B** Mass is a force.
- C** Weights can be compared using a balance.
- D** Weight is a force.

- 5 The diagrams show an empty container, and the same container filled with liquid.

The empty container has a mass of 120 g. When filled with the liquid, the total mass of the container and the liquid is 600 g.



empty container
120 g

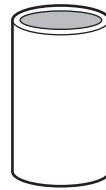

container filled with liquid
600 g

The volume of liquid in the container is 600 cm^3 .

What is the density of the liquid?

- A** 0.020 g/cm^3 **B** 0.80 g/cm^3 **C** 1.0 g/cm^3 **D** 1.2 g/cm^3
- 6 The diagram shows all the horizontal forces acting on a truck.

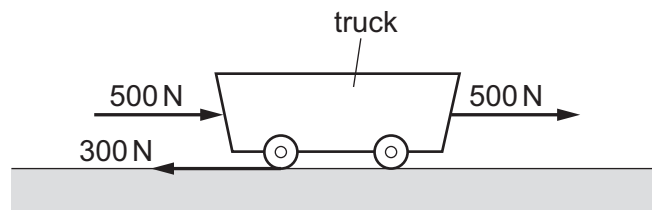

What is the size of the resultant horizontal force on the truck?

- A** 200 N **B** 300 N **C** 700 N **D** 1000 N

- 7 Different loads are hung on a spring. The diagram shows the length of the spring with and without the loads attached.

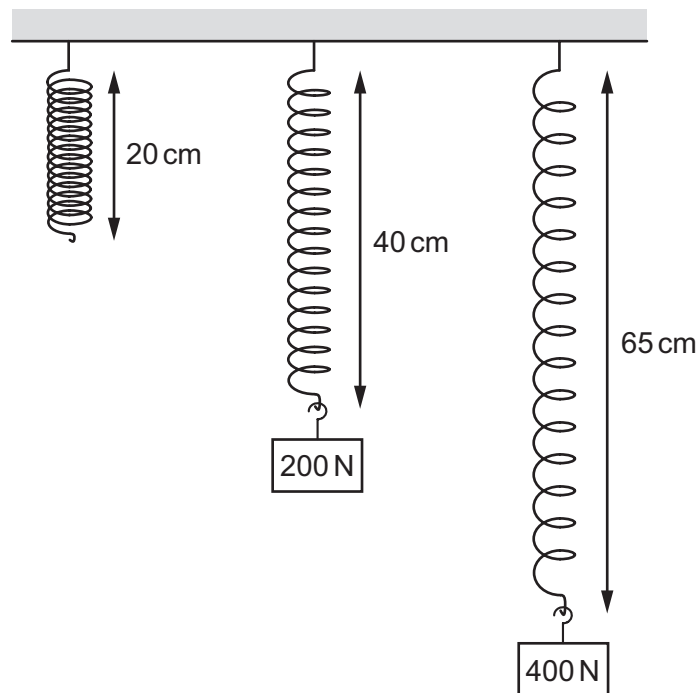

What is the extension of the spring when the load is 400 N?

- A 5 cm B 25 cm C 40 cm D 45 cm
- 8 A uniform bar is pivoted at its centre.

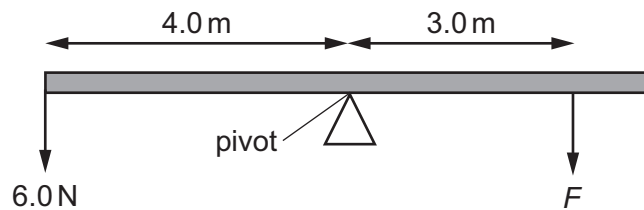

What force F is needed to balance the bar?

- A 2.0 N B 4.5 N C 6.0 N D 8.0 N

- 9 A ball is released from point X on a rough semicircular track. It comes to rest for an instant at point Y. The gravitational potential energy of the ball at point X is E_X . The gravitational potential energy of the ball at point Y is E_Y .



Which equation relates the energy of the ball at point X to its energy at point Y?

- A $E_X = E_Y + \text{work done against friction}$
B $E_X = E_Y - \text{work done against friction}$
C $E_X + E_Y = \text{work done against friction}$
D $E_X + E_Y + \text{work done against friction} = 0$
- 10 Two cars P and Q have different engines.
The input power from the fuel is the same for both engines. The engine in car P is more efficient than the engine in car Q.
Which statement about the cars or their engines **must** be true?
A Car P has a higher maximum speed than car Q.
B Car P has a lower maximum speed than car Q.
C The engine in car P uses less energy per hour than the engine in car Q.
D The engine in car P wastes less energy per hour than the engine in car Q.
- 11 A child runs up a set of stairs four times. The time taken for each run is recorded.
Which time is measured when the child's useful power is greatest?
A 10 s B 20 s C 30 s D 40 s

- 12 The diagrams show the actual sizes of the heels of four different shoes, as seen from underneath the shoe.

Which heel is **most** likely to cause damage to wooden floors?

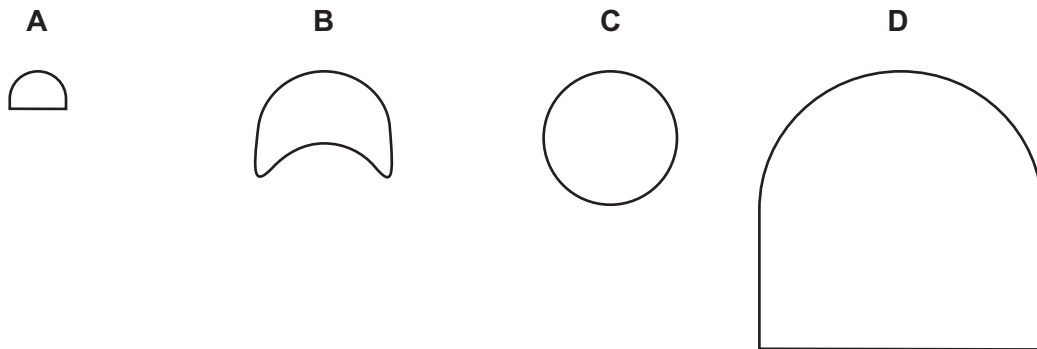

- 13 The diagram shows an instrument used to measure gas pressure.

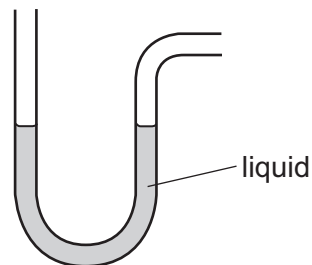

What is the instrument called?

- A ammeter
 - B barometer
 - C manometer
 - D thermometer
- 14 Which diagram best represents the movement of a smoke particle displaying Brownian motion?

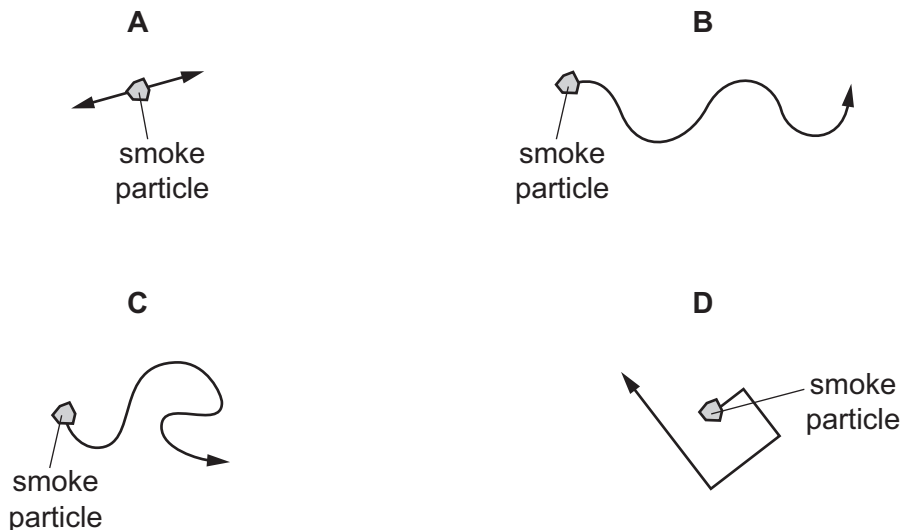

- 15 A cylinder containing trapped air is put into a freezer.



As the air cools, the piston moves to the left as shown.

How has the air changed?

- A Its density is less.
 - B Its mass is less.
 - C The average speed of its molecules is less.
 - D The average volume of its molecules is less.
- 16 A piece of melting ice at 0°C and a beaker of boiling water are both in a laboratory. The laboratory is at 20°C .

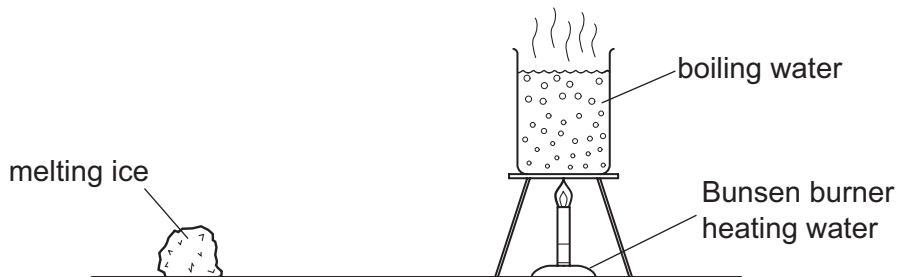

What is happening to the temperature of the melting ice and what is happening to the temperature of the boiling water?

	temperature of melting ice	temperature of boiling water
A	constant	constant
B	constant	increasing
C	increasing	constant
D	increasing	increasing

- 17 A liquid-in-glass thermometer works because the liquid shows a change in
- A colour.
 - B mass.
 - C thermal capacity.
 - D volume.
- 18 Which description applies to infra-red radiation?
- A longitudinal and electromagnetic
 - B longitudinal but not electromagnetic
 - C transverse and electromagnetic
 - D transverse but not electromagnetic

- 19 The diagram shows the temperature-time graph for hot water that is cooling in an uninsulated beaker.

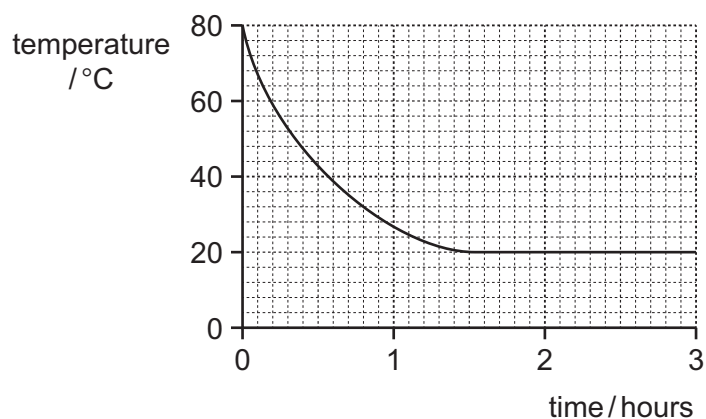

The beaker is now insulated. The same volume of hot water, at the same initial temperature as before, is put into the insulated beaker. The beaker is in the same room as before.

Which is the new temperature-time graph for the water as it cools?

A

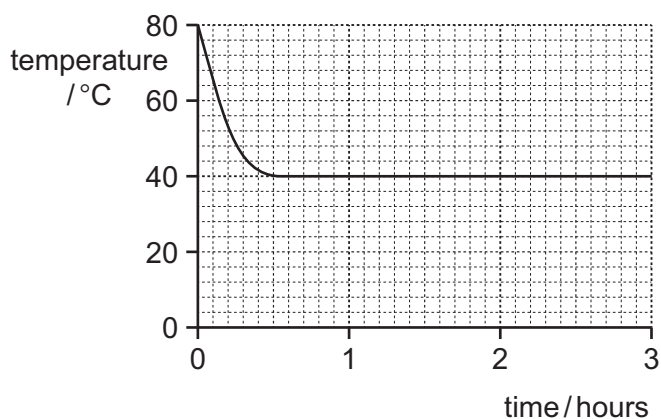

B

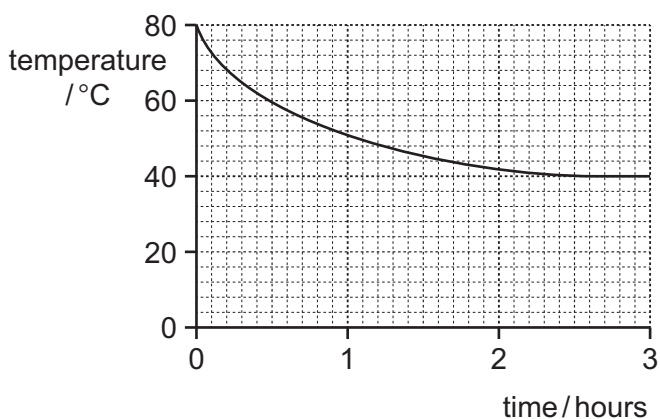

C

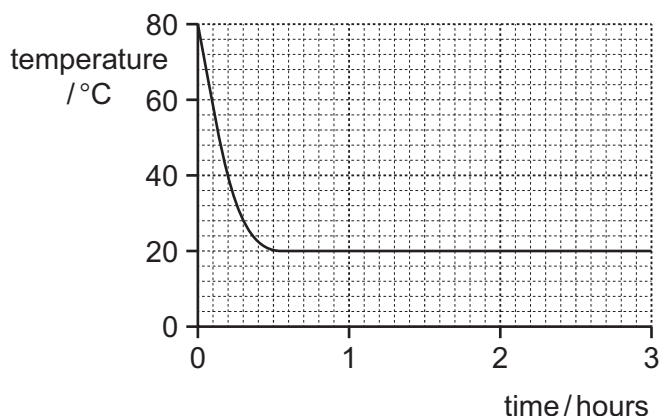

D

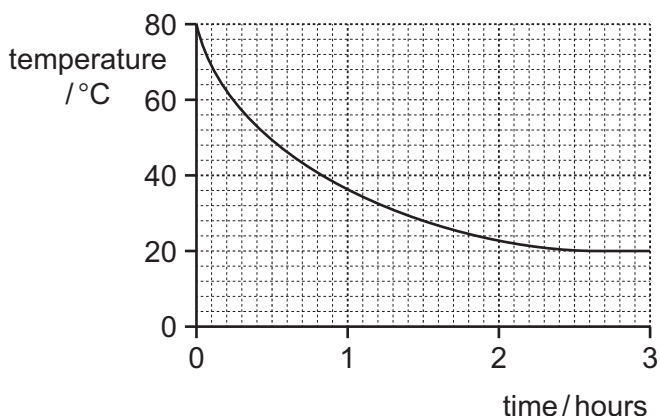

- 20 A small plastic ball floats on the surface of deep water. A stone is dropped into the water at point X.

A wave spreads out across the water surface, causing the ball to move.

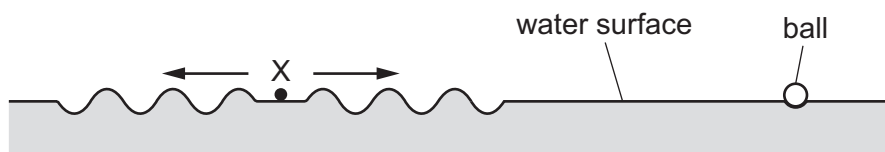

Which type of wave is produced by the stone, and in which direction does the ball move?

	type of wave	direction of movement of ball
A	longitudinal	left and right
B	longitudinal	up and down
C	transverse	left and right
D	transverse	up and down

- 21 Waves travel more slowly on the surface of shallow water than on the surface of deep water.

Which diagram shows a wave travelling from deep water into shallower water?

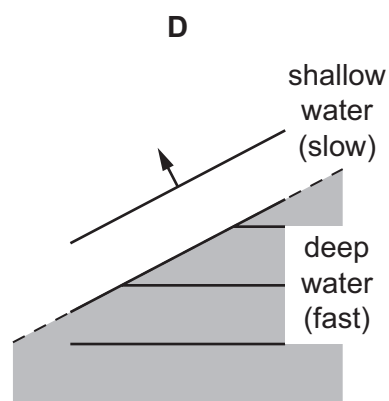
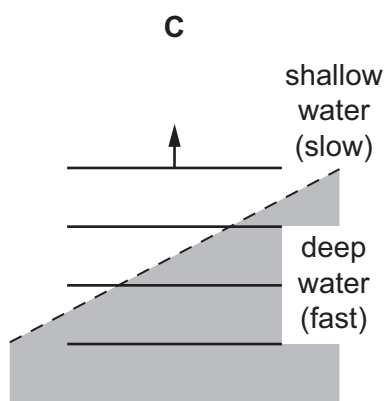
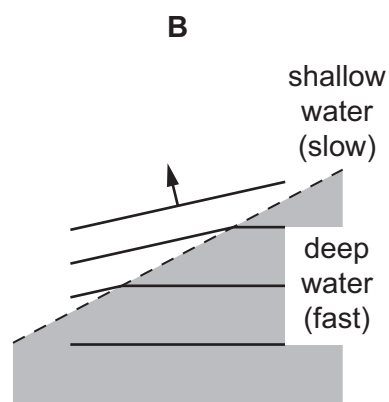
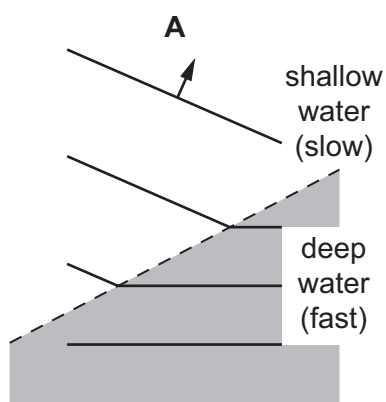

- 22 Light strikes a plane mirror and is reflected. The angle between the ray of light and the mirror is 20° .

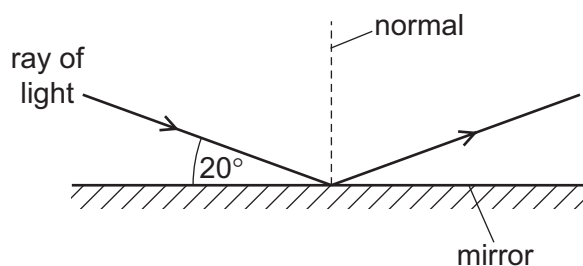

What is the size of the angle of reflection?

- A 20° B 70° C 140° D 160°
- 23 A student draws a ray diagram to show how a converging lens, of focal length f , forms an image of an object.

He draws three rays to locate the image.

He then adds a fourth ray after the position of the image is known.

Which of the labelled rays must have been drawn after the position of the image was known?

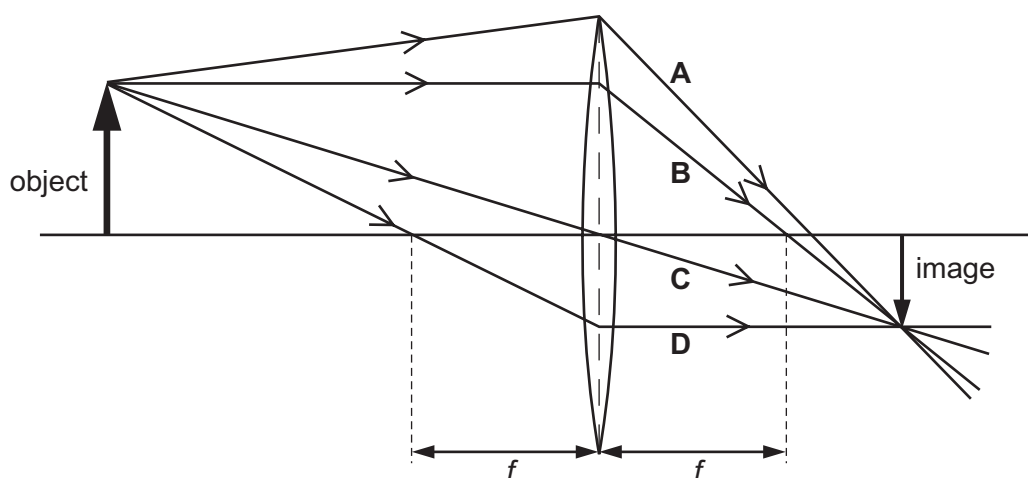

- 24 Which group shows four electromagnetic waves in order, from the largest wavelength to the smallest?
- A microwaves, radio waves, X-rays, visible light
- B radio waves, microwaves, visible light, X-rays
- C visible light, X-rays, radio waves, microwaves
- D X-rays, visible light, microwaves, radio waves

25 A girl notices that, when she shouts into a cave, she hears an echo.

Which wave property causes the echo?

- A diffraction
- B dispersion
- C reflection
- D refraction

26 A man stands 110m from a high wall. He makes a short, sharp sound and then hears an echo from the wall.

The speed of sound in air is 330 m/s.

How long after making the sound does the man hear the echo?

- A 0.33 s
- B 0.67 s
- C 1.5 s
- D 3.0 s

27 In two separate experiments, a magnet is brought near to an unmagnetised iron bar. This causes the bar to become magnetised.

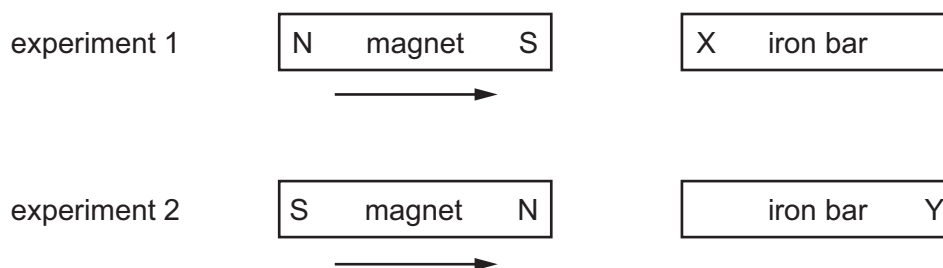

Which magnetic pole is induced at X and at Y?

	pole induced at X	pole induced at Y
A	N	N
B	N	S
C	S	N
D	S	S

28 A student holds a rod in his hand.

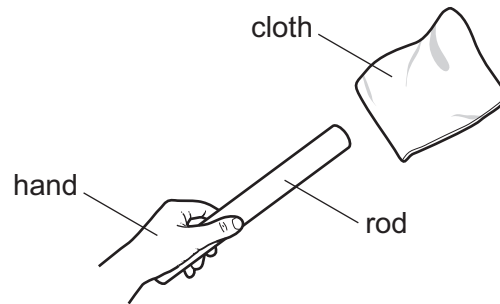

He rubs the rod with a cloth. The rod gains a positive charge.

Of which material could the rod be made, and which transfer of charge has happened?

	material of rod	transfer of charge
A	metal	negative charge from rod to cloth
B	metal	positive charge from cloth to rod
C	plastic	negative charge from rod to cloth
D	plastic	positive charge from cloth to rod

29 The diagram shows a lamp in a circuit.

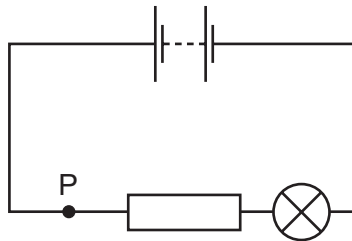

Which change to the circuit would increase the current in the lamp?

- A** adding another resistor in parallel with the one in the circuit
- B** adding another resistor in series with the one in the circuit
- C** decreasing the electromotive force (e.m.f.) of the battery in the circuit
- D** moving the lamp to point P in the circuit

- 30 An ammeter and an 18Ω resistor are connected in series with a battery. The reading on the ammeter is 0.50 A .

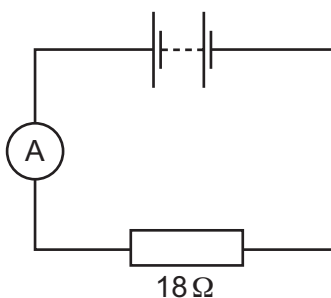

What is the electromotive force (e.m.f.) of the battery?

- A 9.0 N B 9.0 V C 36 N D 36 V
- 31 In which circuit will the ammeter reading be greatest?

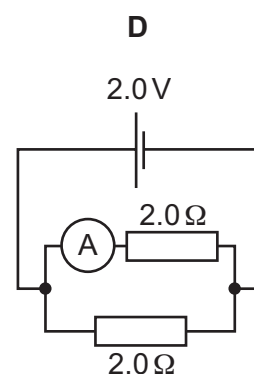
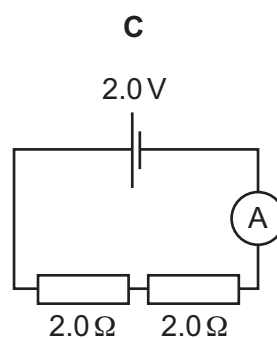
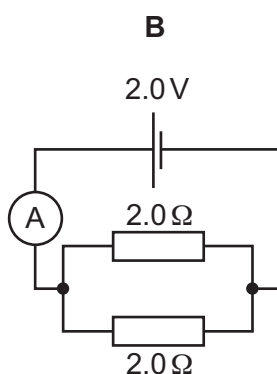
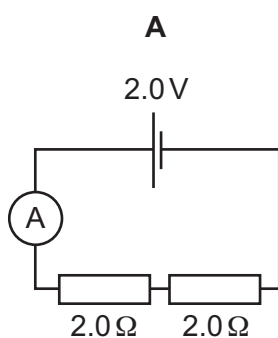

- 32 An electric washing machine is protected by an earth wire.

To which part of the washing machine should the earth wire be connected?

- A the fuse
 B the live wire
 C the metal case
 D the switch

33 The diagram shows a potential divider.

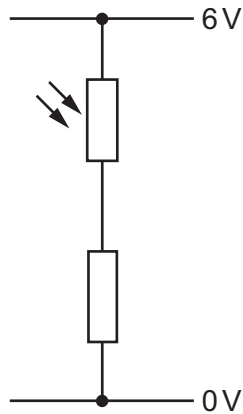

When brighter light falls on the light-dependent resistor (LDR), its resistance changes.

What happens to the resistance of the LDR and what happens to the current in it?

	resistance of LDR	current in LDR
A	decreases	decreases
B	decreases	increases
C	increases	decreases
D	increases	increases

34 Why is a fuse used in an electrical circuit?

- A** so that the current can have only one value
- B** to prevent the current becoming too large
- C** to provide a path to earth if a fault occurs
- D** to save electrical energy

35 Which transformer can change a 240V a.c. input into a 15V a.c. output?

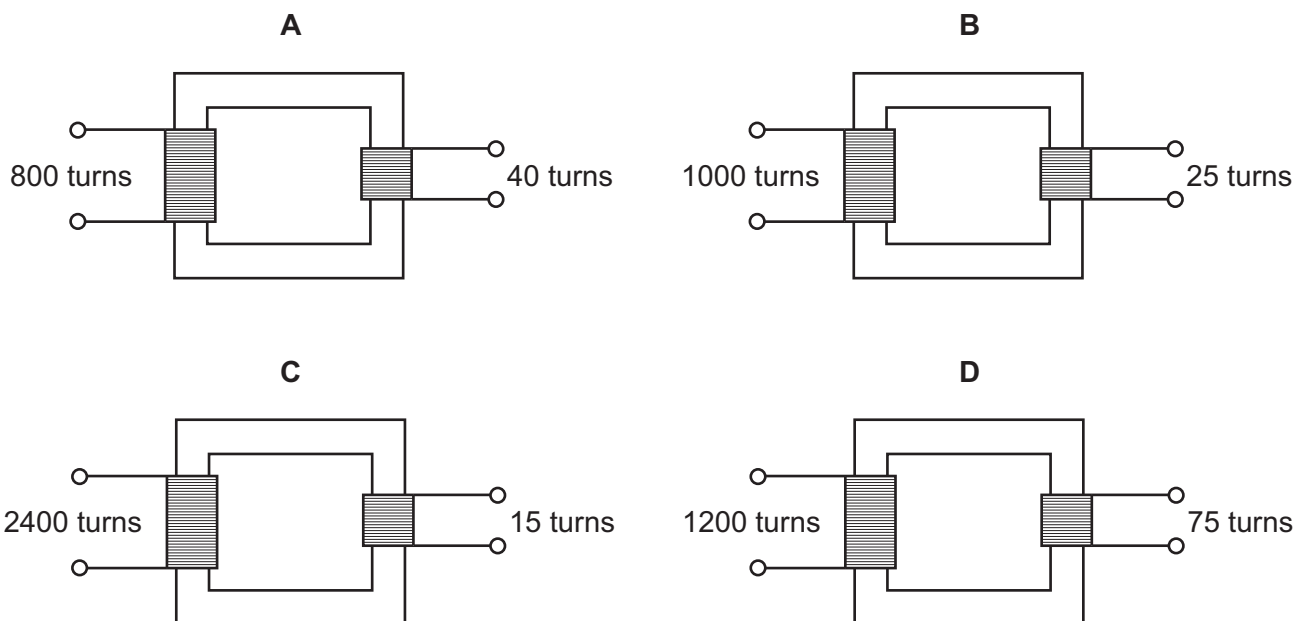

36 An electric current can produce a heating effect and a magnetic effect.

Which row shows the effect that a relay uses and one application of a relay?

	effect used by a relay	one application of a relay
A	heating effect	allowing a small current to switch on a large current
B	heating effect	changing the voltage of an a.c. supply
C	magnetic effect	allowing a small current to switch on a large current
D	magnetic effect	changing the voltage of an a.c. supply

37 A nuclide of sodium can be represented by ${}_{11}^{23}\text{Na}$.

Which row gives the numbers of particles in a neutral sodium atom?

	number of electrons	number of protons	number of neutrons
A	11	11	12
B	12	11	23
C	12	12	11
D	23	23	11

38 Below are four statements about different isotopes of a certain element.

Which statement **must** be true?

- A They have a different number of electrons.
- B They have the same number of neutrons.
- C They have the same number of nucleons.
- D They have the same number of protons.

39 Radioactive source S emits α -particles, β -particles and γ -rays. A detector is placed 5 cm away from S. A thin sheet of paper is placed as shown in the diagram.

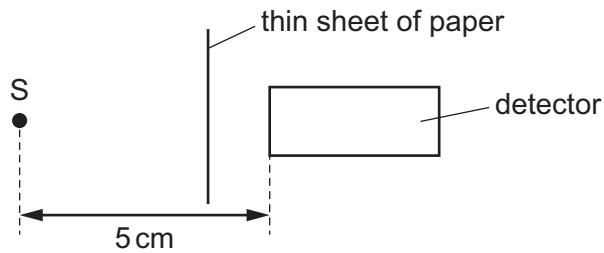

Which emissions from the source can be detected?

- A α -particles and β -particles only
- B α -particles and γ -rays only
- C β -particles and γ -rays only
- D α -particles, β -particles and γ -rays

40 A radioactive material emits α -particles.

The table shows the rate of emission of α -particles from the material at different times.

time / hours	rate of emission / particles per minute
0.0	160
4.0	40
8.0	

What is the half-life of the material and what is the missing value at 8.0 hours?

	half-life / hours	rate of emission at 8.0 hours / particles per minute
A	2.0	0
B	2.0	10
C	4.0	0
D	4.0	10

BLANK PAGE

Permission to reproduce items where third-party owned material protected by copyright is included has been sought and cleared where possible. Every reasonable effort has been made by the publisher (UCLES) to trace copyright holders, but if any items requiring clearance have unwittingly been included, the publisher will be pleased to make amends at the earliest possible opportunity.

To avoid the issue of disclosure of answer-related information to candidates, all copyright acknowledgements are reproduced online in the Cambridge International Examinations Copyright Acknowledgements Booklet. This is produced for each series of examinations and is freely available to download at www.cie.org.uk after the live examination series.

Cambridge International Examinations is part of the Cambridge Assessment Group. Cambridge Assessment is the brand name of University of Cambridge Local Examinations Syndicate (UCLES), which is itself a department of the University of Cambridge.