

CAMBRIDGE INTERNATIONAL EXAMINATIONS
International General Certificate of Secondary Education

BIOLOGY

0610/01

Paper 1 Multiple Choice

May/June 2003

45 minutes

Additional Materials: Multiple Choice Answer Sheet
Soft clean eraser
Soft pencil (type B or HB is recommended)

READ THESE INSTRUCTIONS FIRST

Write in soft pencil.

Do not use staples, paper clips, highlighters, glue or correction fluid.

Write your name, Centre number and candidate number on the answer sheet in the spaces provided unless this has been done for you.

There are forty questions on this paper. Answer **all** questions. For each question, there are four possible answers, **A, B, C** and **D**.

Choose the **one** you consider correct and record your choice in **soft pencil** on the separate answer sheet.

Read the instructions on the Answer Sheet very carefully.

Each correct answer will score one mark. A mark will not be deducted for a wrong answer.
Any rough working should be done in this booklet.

This document consists of **18** printed pages and **2** blank pages.



1 Which of the following lists contains **only** arthropods?

- A annelids, insects, myriapods
- B arachnids, crustaceans, myriapods
- C crustaceans, insects, molluscs
- D insects, myriapods, nematodes

2 The diagram shows a half-flower.

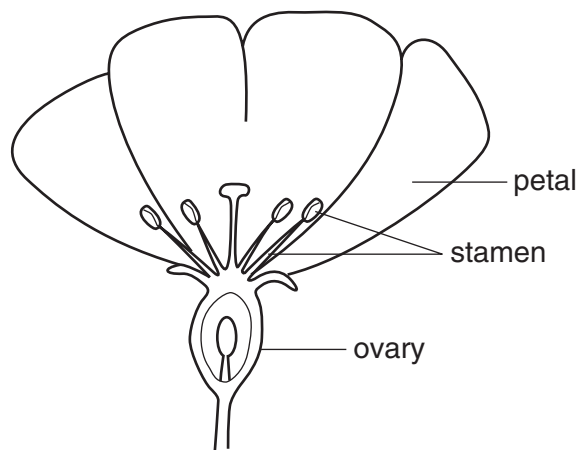

Use the following key to identify the type of flower.

- | | | |
|---|---------------------------------------|---------------|
| 1 | petals attached above the ovary | go to 2 |
| | petals attached below the ovary | go to 3 |
| 2 | stamens less than ten | type A |
| | stamens more than ten | type B |
| 3 | sepals absent | type C |
| | sepals present | type D |

- 3 The diagram shows some external features of a rat.

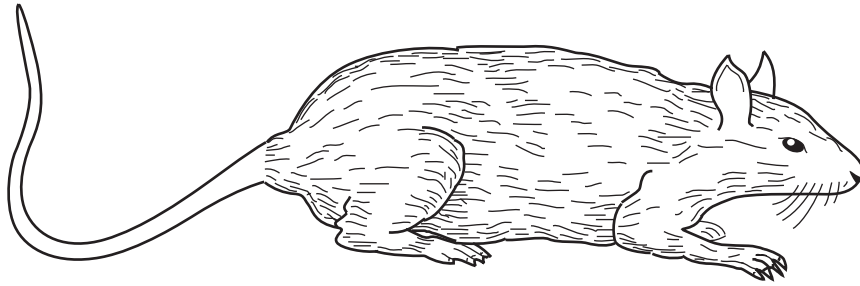

Which features, seen in the diagram, show that a rat is a mammal?

- A diaphragm and lungs
 - B fur and whiskers
 - C legs and tail
 - D milk and sweat production
- 4 The table shows features that may be found in living cells.

Which features are found in a liver cell?

| | large central vacuole | chloroplasts | cellulose cell wall |
|---|-----------------------|--------------|---------------------|
| A | ✓ | ✓ | ✓ |
| B | ✓ | ✓ | ✗ |
| C | ✗ | ✗ | ✓ |
| D | ✗ | ✗ | ✗ |

- 5 The diagram shows a section through a mesophyll cell of a leaf.

Which part is partially permeable?

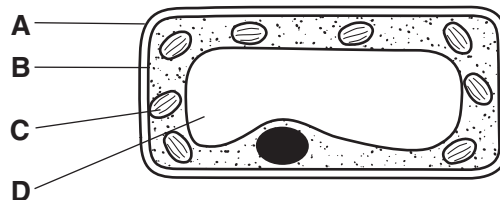

6 The diagram shows four cells.

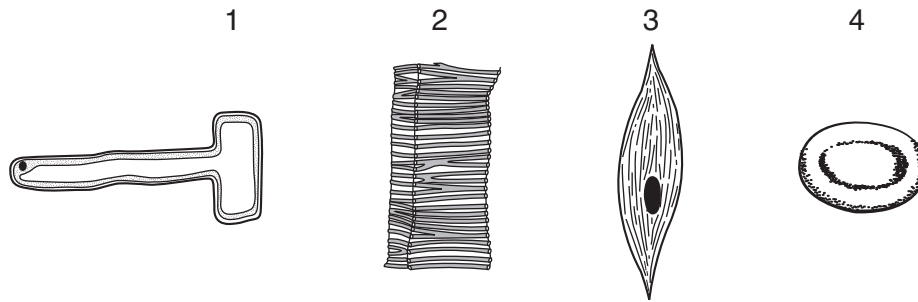

Which cells transport water?

- A 1 and 2
 B 1 and 3
 C 2 and 4
 D 3 and 4
- 7 In the pancreas, there are groups of cells that make insulin.

What describes these cells?

- A an organ in an organism
 B an organ system in an organism
 C cells within a cell wall
 D tissue in an organ
- 8 In an osmosis experiment, four potato strips, each 5 cm in length, were left in salt solutions of different concentrations.

The table shows the lengths of the strips after 30 minutes.

Which salt solution was the **most** concentrated?

| salt solution | length of strips after 30 minutes |
|---------------|-----------------------------------|
| A | 4.5 cm |
| B | 4.8 cm |
| C | 5.0 cm |
| D | 5.3 cm |

9 The diagram shows a section through a leaf.

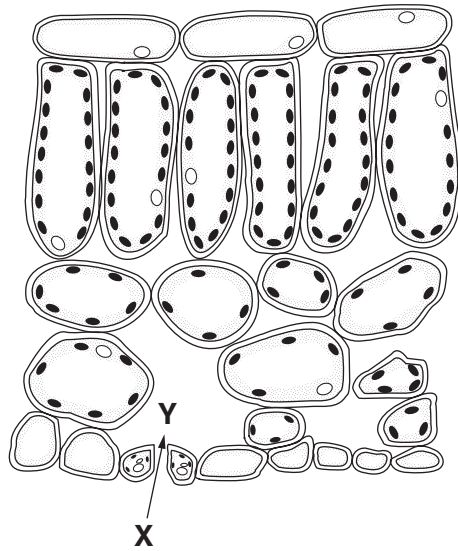

By which process does carbon dioxide pass from **X** to **Y**?

- A diffusion
- B osmosis
- C translocation
- D transpiration

10 The graph shows how the rate of an enzyme-controlled reaction changes with pH.

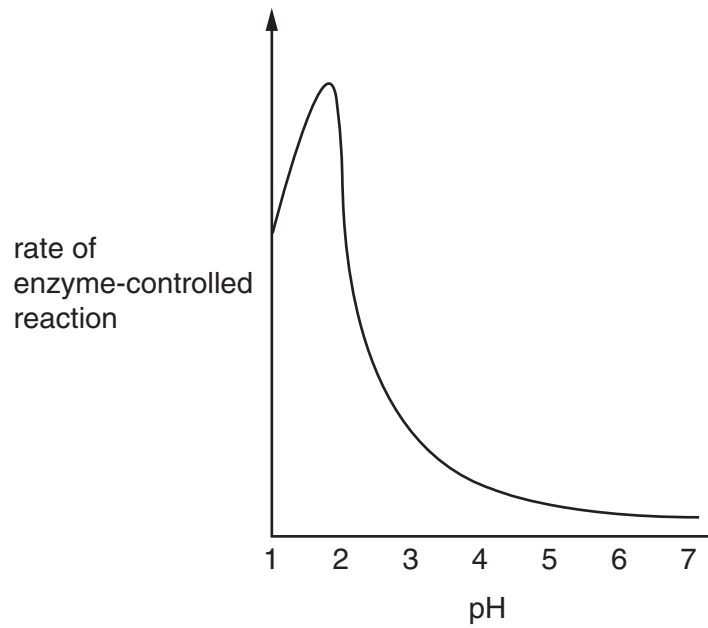

Which statement is correct?

- A This enzyme is destroyed by acidic conditions.
 - B This enzyme works best in acidic conditions.
 - C This enzyme works best in alkaline conditions.
 - D This enzyme works best in neutral conditions.
- 11 Which kind of molecule could be an enzyme?

- A fat
- B glucose
- C protein
- D starch

12 The table shows the mass of some nutrients found in 100 g of four different foods.

| food | carbohydrate /g | fat /g | protein /g | vit C /mg | vit D /mg |
|--------|-----------------|--------|------------|-----------|-----------|
| beans | 10.0 | 0.4 | 5.0 | 3.0 | 0.0 |
| bread | 48.0 | 1.5 | 9.0 | 0.0 | 0.0 |
| cheese | 0.0 | 34.0 | 25.0 | 0.0 | 0.4 |
| eggs | 0.0 | 11.0 | 13.0 | 0.0 | 1.5 |

Which foods would best prevent rickets and scurvy?

| | rickets | scurvy |
|----------|---------|--------|
| A | beans | bread |
| B | bread | cheese |
| C | cheese | eggs |
| D | eggs | beans |

13 The diagram shows some food moving along the alimentary canal.

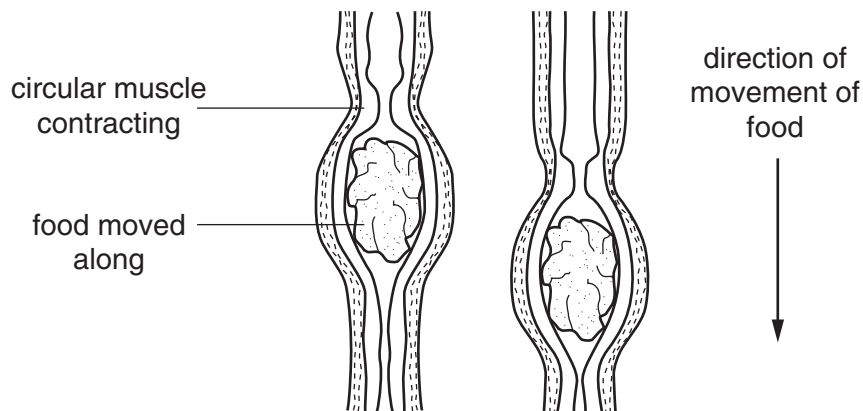

What is the name of the process that pushes the food along?

- A** absorption
- B** digestion
- C** peristalsis
- D** swallowing

Use this diagram, which shows a cross-section through a leaf, to answer questions 14 and 15.

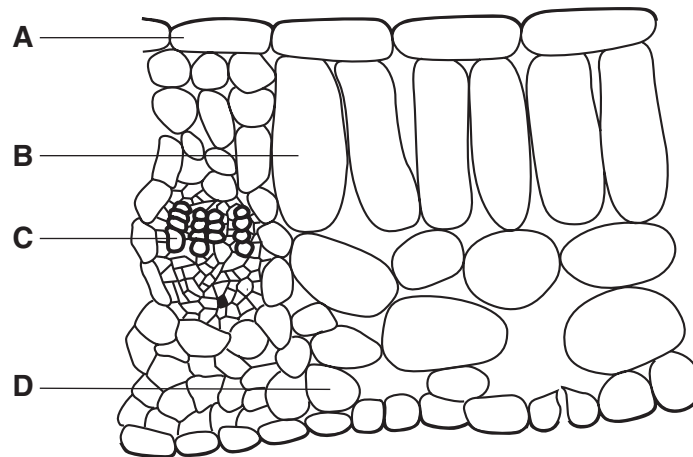

14 Which cell type absorbs the most carbon dioxide during the day?

15 A leafy shoot is placed in a solution of red dye.

After 30 minutes, which part of a leaf from this shoot will contain the red dye?

16 The diagram shows cross-sections of three types of blood vessel (not drawn to the same scale).

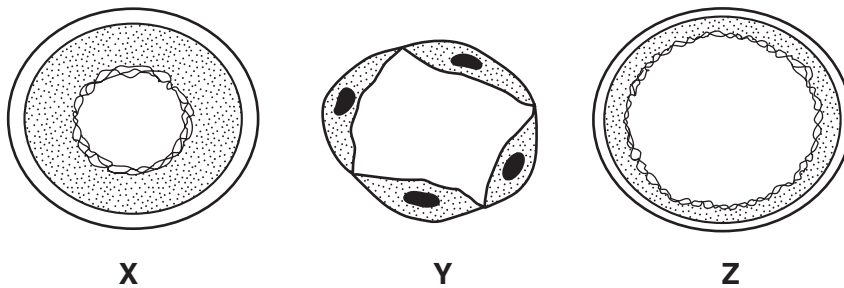

What is the identity of the three vessels?

| | artery | capillary | vein |
|----------|--------|-----------|------|
| A | X | Y | Z |
| B | Y | X | Z |
| C | X | Z | Y |
| D | Y | Z | X |

17 What is happening in a bolus of food as it passes along the oesophagus?

- A Fats are being digested.
- B Fats are being emulsified.
- C Protein is being digested.
- D Starch is being digested.

18 The photograph shows some blood as seen under the microscope.

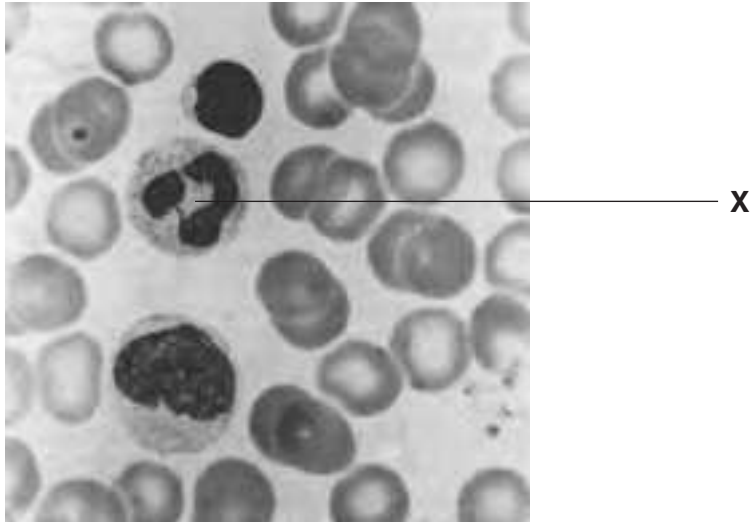

What is the function of the cell labelled X?

- A blood clotting
- B carrying oxygen
- C defending against disease
- D transporting hormones

19 The roots of green plants take up nitrates from the soil.

What are the nitrates used to make?

- A fat
- B glucose
- C protein
- D starch

20 Which substance in cigarette smoke causes lung cancer?

- A carbon dioxide
- B carbon monoxide
- C nicotine
- D tar

21 Why does anaerobic respiration by yeast release less energy than aerobic respiration?

- A Energy is lost in carbon dioxide.
- B Energy is lost in oxygen.
- C Energy remains trapped in ethanol.
- D Energy remains trapped in lactic acid.

22 In which organ are excess amino acids broken down?

- A bladder
- B brain
- C kidneys
- D liver

23 The diagram shows a section through part of the human eye.

Which part contains muscles?

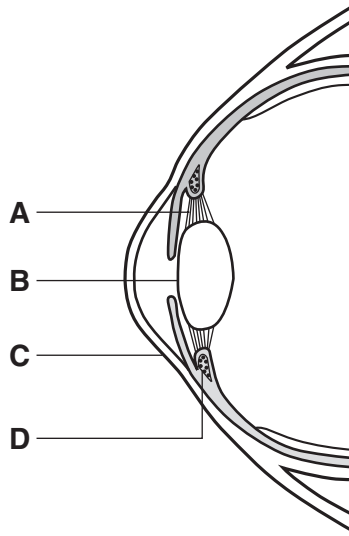

24 The diagram shows a germinated bean seed with a horizontal radicle. This is placed on a slowly rotating disc and is left for three days.

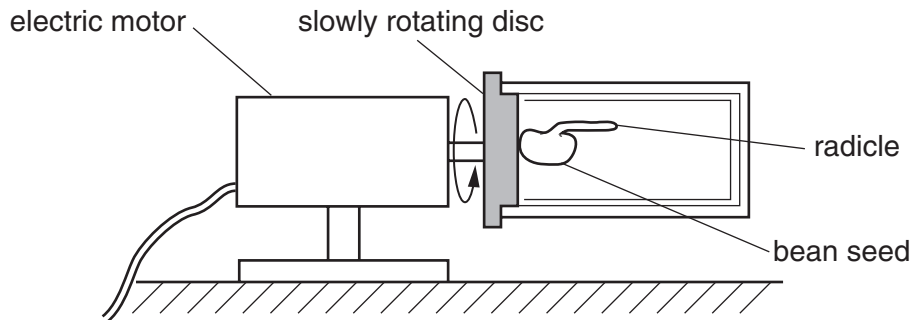

Which diagram shows the appearance of the radicle after three days?

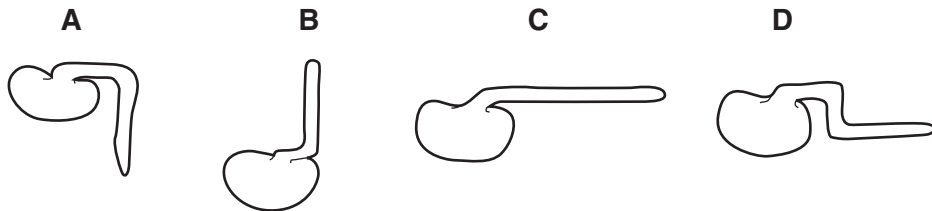

25 The diagram shows the male reproductive system.

Where is testosterone produced?

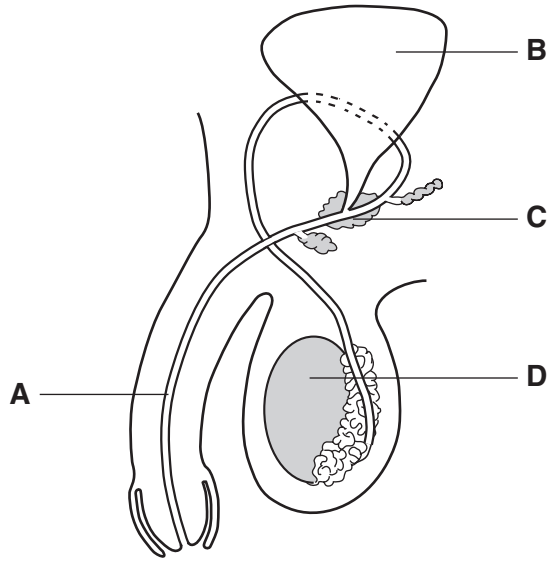

26 The diagram shows stages in the life of a human from zygote to fetus.

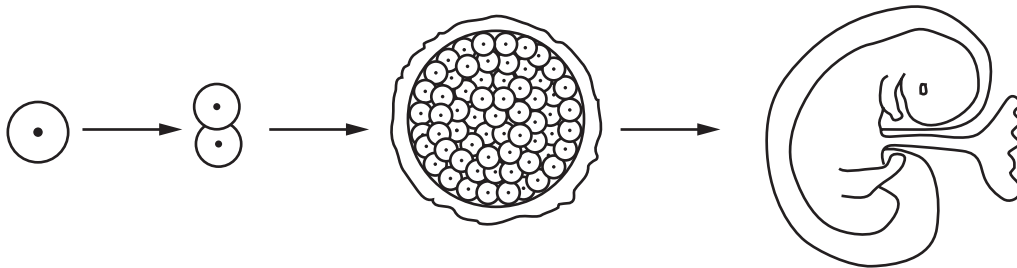

Which processes occur during these stages?

| | fertilisation | growth | development |
|----------|---------------|--------|-------------|
| A | ✓ | ✗ | ✓ |
| B | ✓ | ✗ | ✗ |
| C | ✗ | ✓ | ✗ |
| D | ✗ | ✓ | ✓ |

27 The diagram shows stages of a menstrual cycle.

During which stage is a woman most fertile?

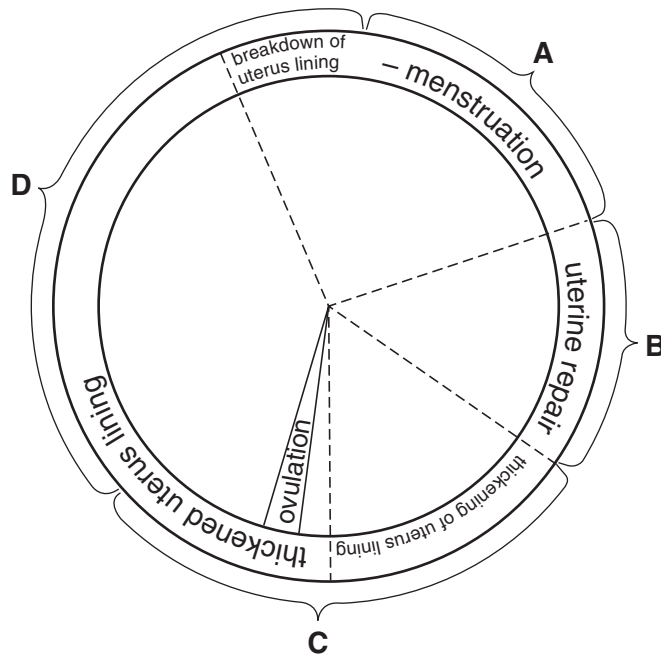

28 The diagram shows a germinating bean seed with the seed coat removed.

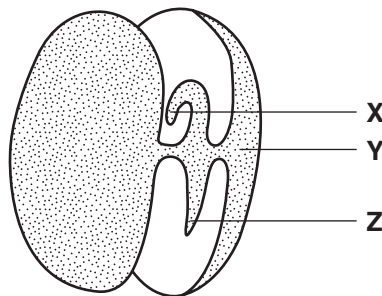

What are the structures X, Y and Z?

| | structure | | |
|---|-----------|-----------|-----------|
| | X | Y | Z |
| A | cotyledon | radicle | plumule |
| B | plumule | cotyledon | radicle |
| C | plumule | radicle | cotyledon |
| D | radicle | plumule | cotyledon |

29 Which are needed for seed germination?

- A carbon dioxide and oxygen
- B chlorophyll and light
- C soil particles and mineral salts
- D water and a suitable temperature

30 The nucleus in each cell in the stem of a plant contains 32 chromosomes.

How many chromosomes are there in the nuclei of its pollen grains?

- A 8
- B 16
- C 32
- D 64

31 A heterozygous, brown-eyed woman and a blue-eyed man have a child.

If the allele for brown eyes is dominant to the allele for blue eyes, what are the chances that the child is blue-eyed?

- A 1 in 2
- B 1 in 3
- C 1 in 4
- D none

32 A female fruit fly with short wings mates with a male with long wings. All the offspring are long-winged.

Two of these offspring mate with each other.

What percentage of their offspring will have long wings?

- A 25 %
- B 50 %
- C 75 %
- D 100 %

33 The diagram shows a simple food chain.

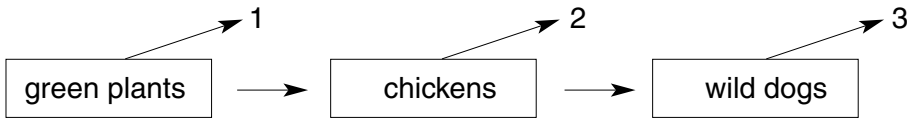

Which process releases the energy which is then lost at 1, 2 and 3?

- A evaporation
- B photosynthesis
- C respiration
- D translocation

34 The diagram shows another simple food chain.

Which is the primary (first) consumer?

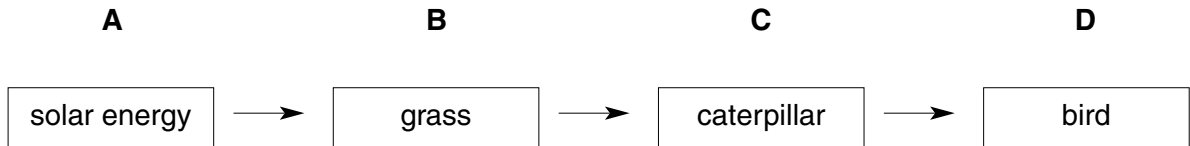

35 The diagram shows part of the water cycle.

Which arrow represents condensation?

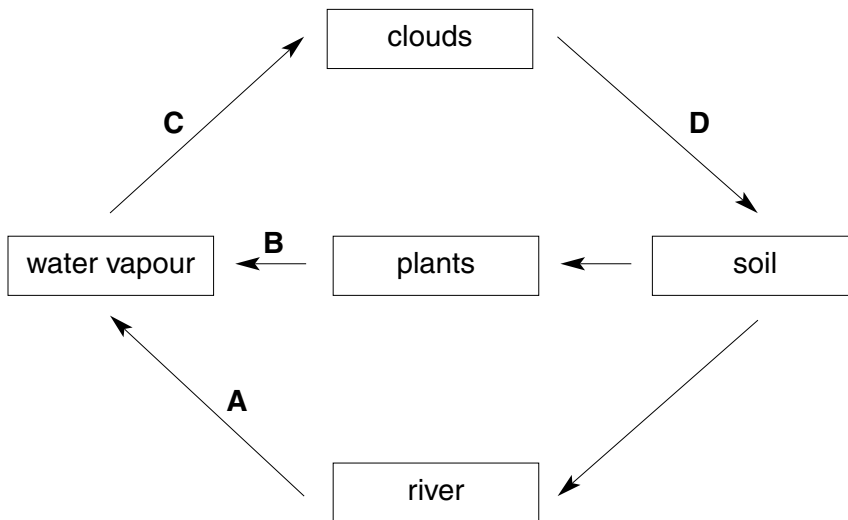

36 The diagram shows the release of a gas into the atmosphere from different sources.

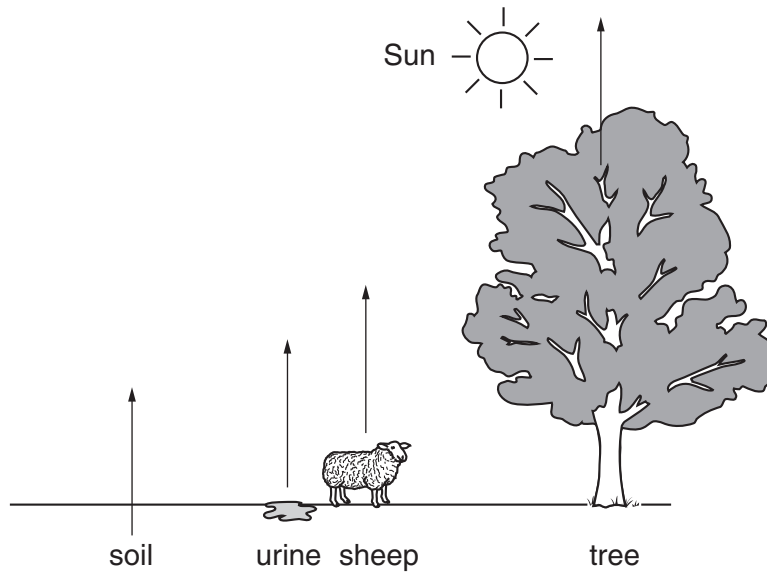

What is this gas?

- A carbon dioxide
- B nitrogen
- C oxygen
- D water vapour

37 The diagram shows part of a food web.

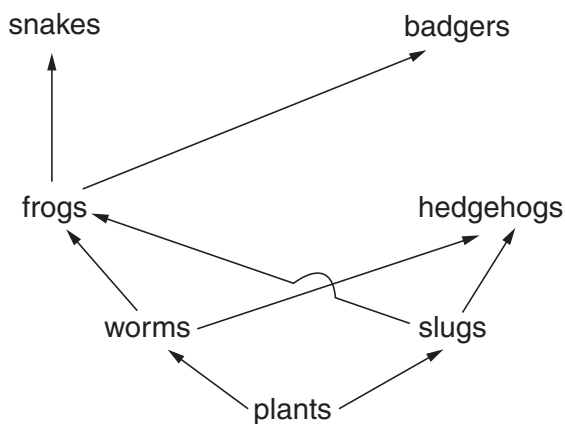

What is most likely to increase the size of the frog population?

- A fewer hedgehogs
- B fewer worms
- C more badgers
- D more snakes

38 The diagram shows how some land near a lake is used.

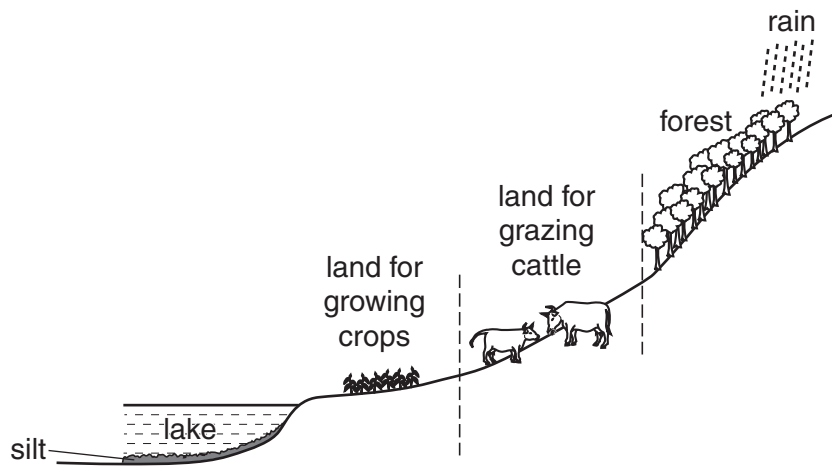

Which of the following is most likely to cause the lake to flood?

- A cutting down the forest
- B removing the cattle
- C taking the silt out of the lake
- D using pesticides on the crops

39 The diagram shows part of a food chain in a lake.

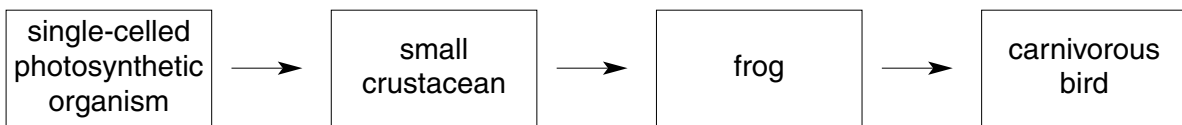

The chart shows the concentration of a pesticide in the bodies of each organism in the chain.

Which organism on the chart is the frog?

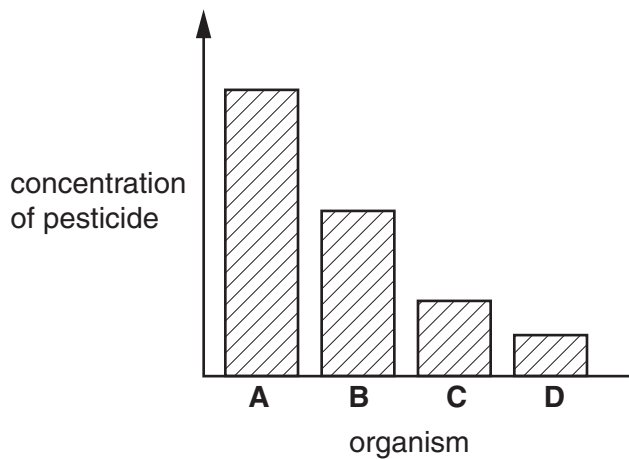

40 The diagram shows an area being developed for industry and agriculture.

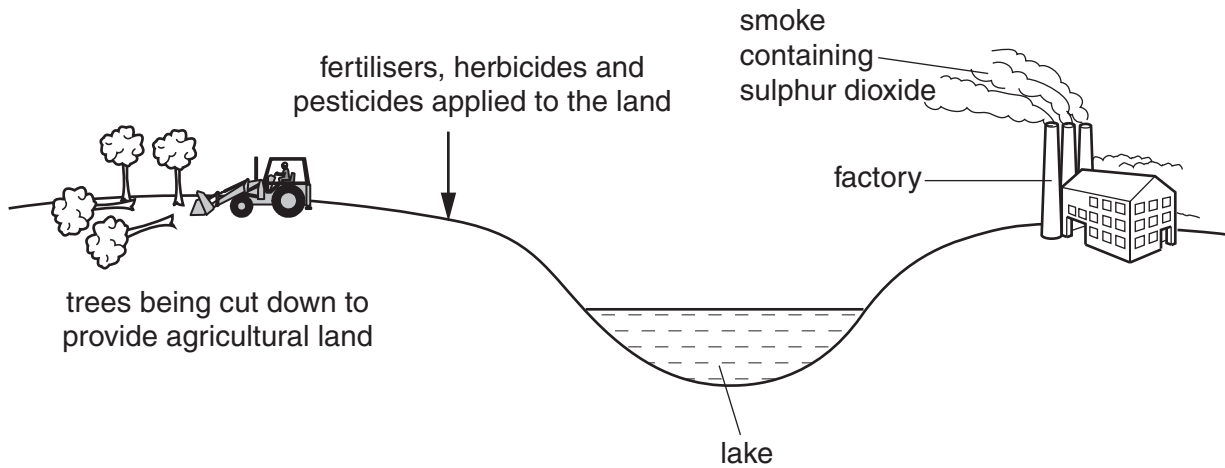

Which would be the most likely to cause an initial increase in plant life in the lake?

- A fertilisers
- B herbicides
- C pesticides
- D smoke

