



CHEMISTRY

Paper 1 Multiple Choice

9701/01

May/June 2008

1 hour

Additional Materials: Multiple Choice Answer Sheet
Soft Clean Eraser
Soft pencil (type B or HB is recommended)
Data Booklet

READ THESE INSTRUCTIONS FIRST

Write in soft pencil.

Do **not** use staples, paper clips, highlighters, glue or correction fluid.

Write your name, Centre number and candidate number on the Answer Sheet in the spaces provided unless this has been done for you.

There are **forty** questions on this paper. Answer **all** questions. For each question there are four possible answers **A, B, C** and **D**.

Choose the **one** you consider correct and record your choice in **soft pencil** on the separate Answer Sheet.

Read the instructions on the Answer Sheet very carefully.

Each correct answer will score one mark. A mark will not be deducted for a wrong answer.

Any rough working should be done in this booklet.

This document consists of **16** printed pages.



Section A

For each question there are four possible answers, **A**, **B**, **C**, and **D**. Choose the **one** you consider to be correct.

- 1 In the Basic Oxygen steel-making process the P_4O_{10} impurity is removed by reacting it with calcium oxide. The only product of this reaction is the salt calcium phosphate, $Ca_3(PO_4)_2$.

In this reaction, how many moles of calcium oxide react with one mole of P_4O_{10} ?

- A** 1 **B** 1.5 **C** 3 **D** 6

- 2 *Use of the Data Booklet is relevant to this question.*

A typical solid fertiliser for use with household plants and shrubs contains the elements N, P, and K in the ratio of 15g : 30g : 15g per 100 g of fertiliser. The recommended usage of fertiliser is 14g of fertiliser per 5 dm³ of water.

What is the concentration of nitrogen atoms in this solution?

- A** 0.03 mol dm⁻³
B 0.05 mol dm⁻³
C 0.42 mol dm⁻³
D 0.75 mol dm⁻³

- 3 Skin cancer can be treated using a radioactive isotope of phosphorus, $^{32}_{15}P$. A compound containing the phosphide ion $^{32}_{15}P^{3-}$, wrapped in a plastic sheet, is strapped to the affected area.

What is the composition of the phosphide ion, $^{32}_{15}P^{3-}$?

	protons	neutrons	electrons
A	15	17	18
B	15	17	32
C	17	15	17
D	32	17	15

- 4 When barium metal burns in oxygen, the ionic compound barium peroxide, BaO_2 , is formed.

Which dot-and-cross diagram represents the electronic structure of the peroxide anion in BaO_2 ?

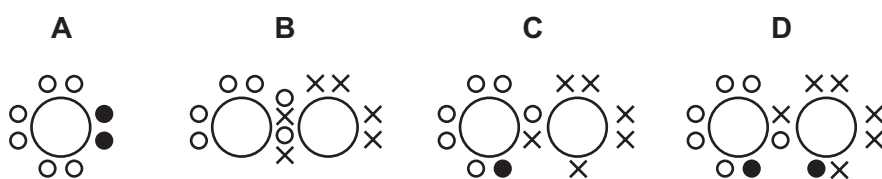

key

- electron from first oxygen atom
- × electron from second oxygen atom
- electron from barium atom

- 5 In this question, the methyl group, CH_3 , is represented by Me.

Trimethylamine, Me_3N , reacts with boron trifluoride, BF_3 , to form a compound of formula $\text{Me}_3\text{N} \cdot \text{BF}_3$.

How may this reaction be written in terms of the shapes of the reactants and products?

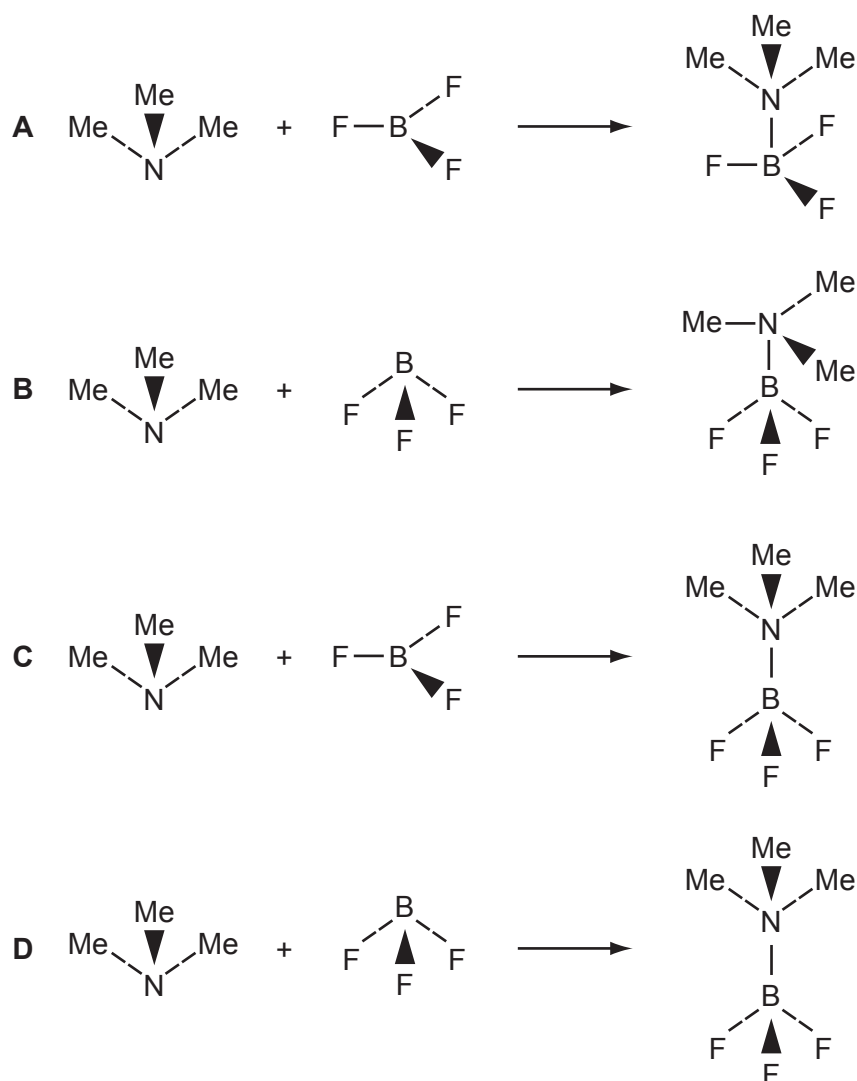

- 6 The density of ice is 1.00 g cm^{-3} .

What is the volume of steam produced when 1.00 cm^3 of ice is heated to $323 \text{ }^\circ\text{C}$ (596 K) at a pressure of one atmosphere (101 kPa)?

[1 mol of a gas occupies 24.0 dm^3 at $25 \text{ }^\circ\text{C}$ (298 K) and one atmosphere.]

- A** 0.267 dm^3 **B** 1.33 dm^3 **C** 2.67 dm^3 **D** 48.0 dm^3
- 7 Which pair of elements have bonds of the same type between their atoms in the solid state?
- A** aluminium and phosphorus
B chlorine and argon
C magnesium and silicon
D sulphur and chlorine
- 8 Which diagram correctly describes the behaviour of a fixed mass of an ideal gas? (T is measured in K.)

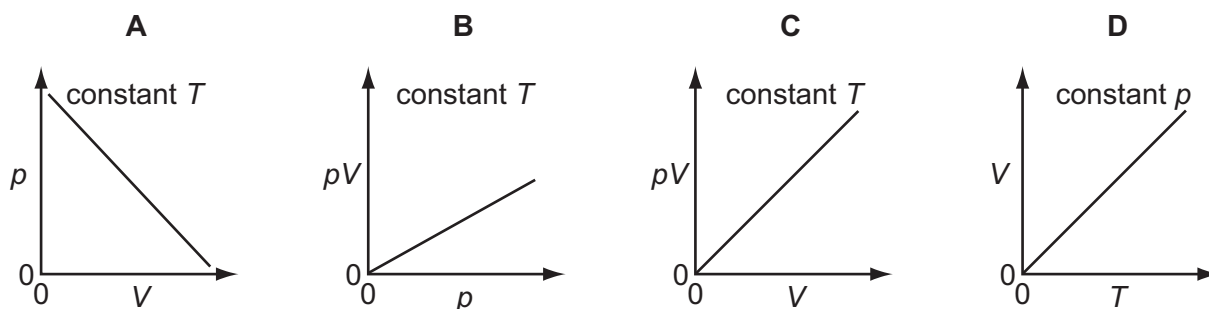

- 9 For which equation does the enthalpy change correspond to the enthalpy change of atomisation of iodine?
- A** $\frac{1}{2} \text{I}_2(\text{s}) \rightarrow \text{I}(\text{s})$
B $\frac{1}{2} \text{I}_2(\text{s}) \rightarrow \text{I}(\text{g})$
C $\text{I}_2(\text{g}) \rightarrow 2\text{I}(\text{g})$
D $\text{I}_2(\text{s}) \rightarrow 2\text{I}(\text{g})$

- 10 Titanium occurs naturally as the mineral rutile, TiO_2 . One possible method of extraction of titanium is to reduce the rutile by heating with carbon.

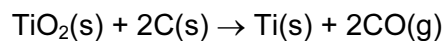

The standard enthalpy changes of formation of $\text{TiO}_2(\text{s})$ and $\text{CO}(\text{g})$ are -940 kJ mol^{-1} and -110 kJ mol^{-1} respectively.

What is the standard enthalpy change of this reaction?

- A -830 kJ mol^{-1}
- B -720 kJ mol^{-1}
- C $+720 \text{ kJ mol}^{-1}$
- D $+830 \text{ kJ mol}^{-1}$

- 11 For the reaction



what are the correct units for the equilibrium constant K_c ?

- A mol dm^{-3}
- B $\text{mol}^2 \text{ dm}^{-6}$
- C $\text{mol}^{-1} \text{ dm}^3$
- D $\text{mol}^{-2} \text{ dm}^6$

- 12 The molecular energy distribution curve represents the variation in energy of the molecules of a gas at room temperature.

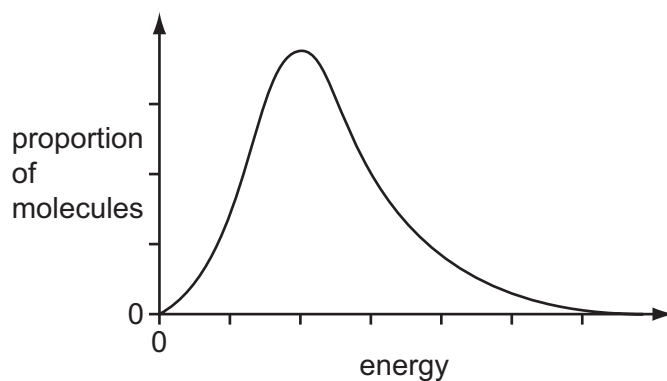

Which curve applies for the same gas at a lower temperature?

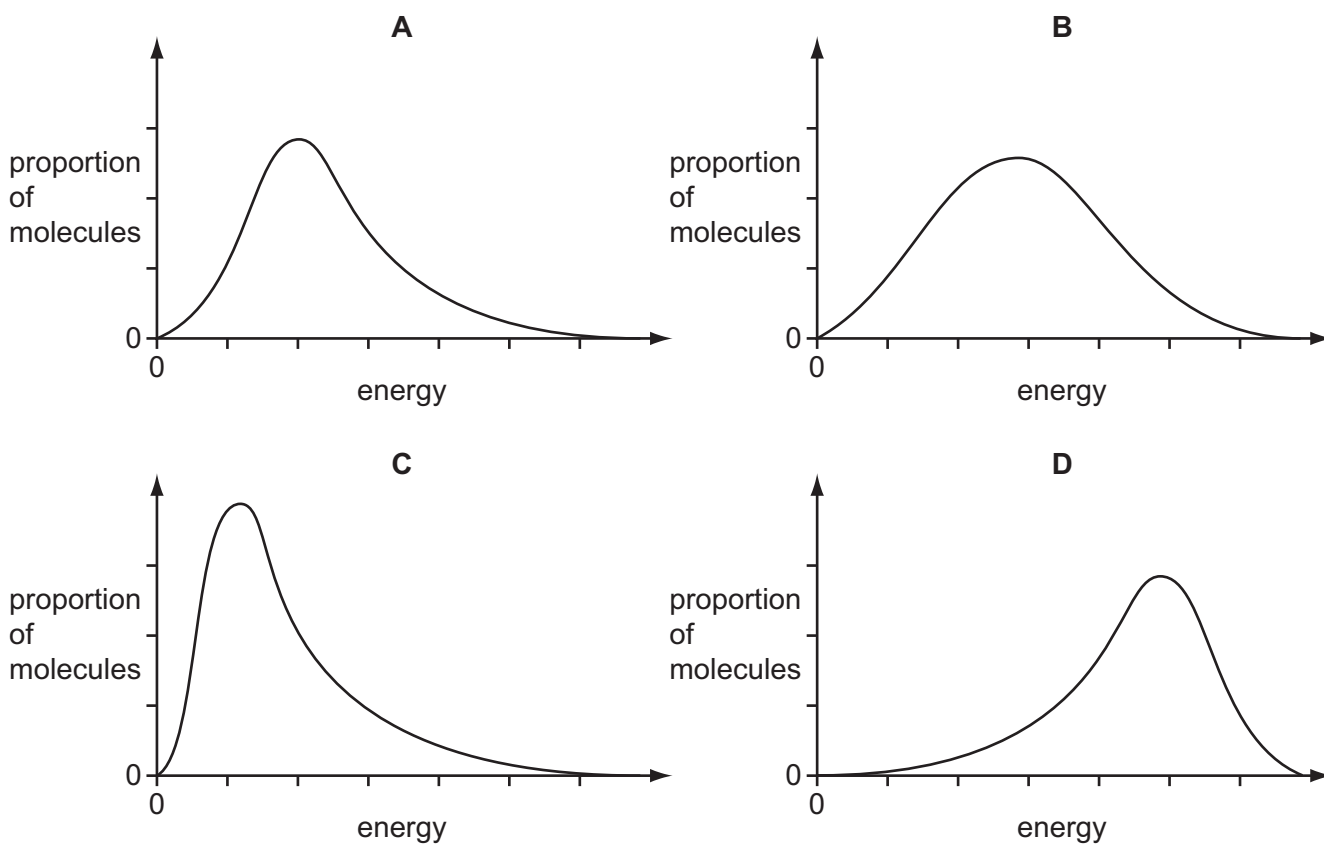

- 13 In an experiment, 0.1 g samples of Na_2O , MgO , P_4O_{10} and SO_2 are added to separate 100 cm^3 volumes of water.

For which oxide is the resulting mixture most alkaline?

- A Na_2O B MgO C P_4O_{10} D SO_2

14 Which element is expected to show the greatest tendency to form some covalent compounds?

- A aluminium
- B calcium
- C magnesium
- D sodium

15 *Use of the Data Booklet is relevant to this question.*

The combustion of fossil fuels is a major source of increasing atmospheric carbon dioxide, with a consequential rise in global warming. Another significant contribution to carbon dioxide levels comes from the thermal decomposition of limestone, in the manufacture of cement and of lime for agricultural purposes.

Cement works roast 1000 million tonnes of limestone per year and a further 200 million tonnes is roasted in kilns to make lime.

What is the total annual mass output of carbon dioxide (in million tonnes) from these two processes?

- A 440 B 527 C 660 D 880

16 Properties of chlorine, iodine and their compounds are compared.

Property **Q** for chlorine is smaller than for iodine.

What is property **Q**?

- A oxidising ability of the element
- B solubility of the silver halide in $\text{NH}_3(\text{aq})$
- C strength of van der Waals' forces between the molecules of the element
- D thermal stability of the hydrogen halide

17 Which reagent, when mixed and heated with ammonium sulphate, liberates ammonia?

- A aqueous bromine
- B dilute hydrochloric acid
- C limewater
- D acidified potassium dichromate(VI)

- 18 The diagram represents the Haber process for the manufacture of ammonia from nitrogen and hydrogen.

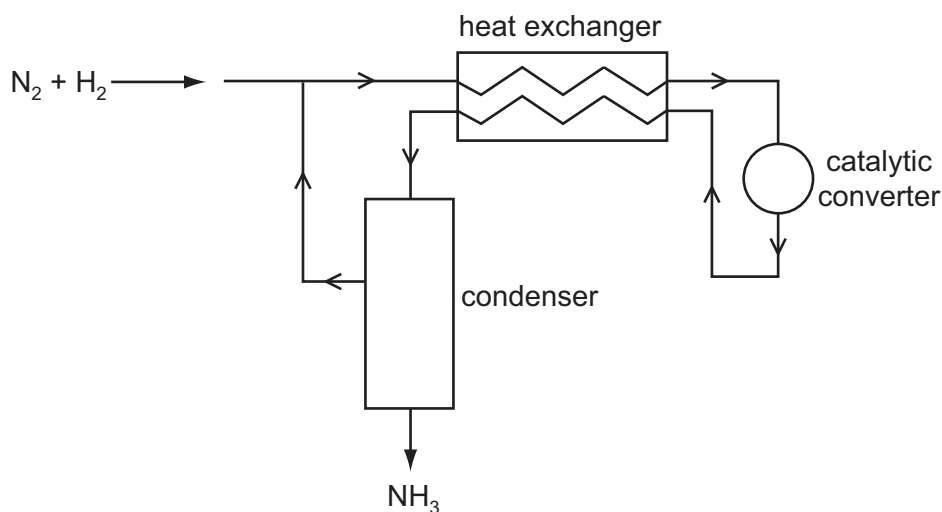

What is the purpose of the heat exchanger?

- A to cool the incoming gas mixture to avoid overheating the catalyst
 B to cool the reaction products and separate the NH_3 from unused N_2 and H_2
 C to warm the incoming gas mixture and shift the equilibrium to give more NH_3
 D to warm the incoming gas mixture and speed up the reaction
- 19 Total elimination of the pollutant sulphur dioxide, SO_2 , is difficult, both for economic and technical reasons. Its emission can be reduced in furnace chimneys using desulphurisation plants, where the gases are scrubbed (washed) with calcium hydroxide to remove the SO_2 .

What is the main product formed initially?

- A CaO B $\text{Ca}(\text{OH})_2$ C CaSO_3 D CaSO_4
- 20 Which pair of reaction types is illustrated by the reaction sequence below?

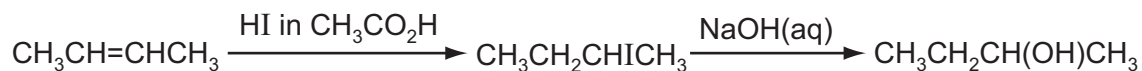

- A electrophilic addition and electrophilic substitution
 B electrophilic addition and nucleophilic substitution
 C nucleophilic addition and electrophilic substitution
 D nucleophilic addition and nucleophilic substitution

21 Trichloroethene is widely used as a dry-cleaning agent.

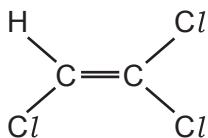

With which of the following does trichloroethene react to give a chiral product?

- A Br_2 B HCl C NaCN(aq) D NaOH(aq)

22 Chloroethene, $\text{CH}_2=\text{CHCl}$, is the monomer of PVC.

What are the C–C–C bond angles along the polymeric chain in PVC?

- A They are all 109.5° .
 B Half are 109.5° and half are 120° .
 C They are all 120° .
 D They are all 180° .

23 Which hydrocarbon would **not** be collected in the inverted tube by heating pentane, $\text{CH}_3(\text{CH}_2)_3\text{CH}_3$, in the apparatus shown?

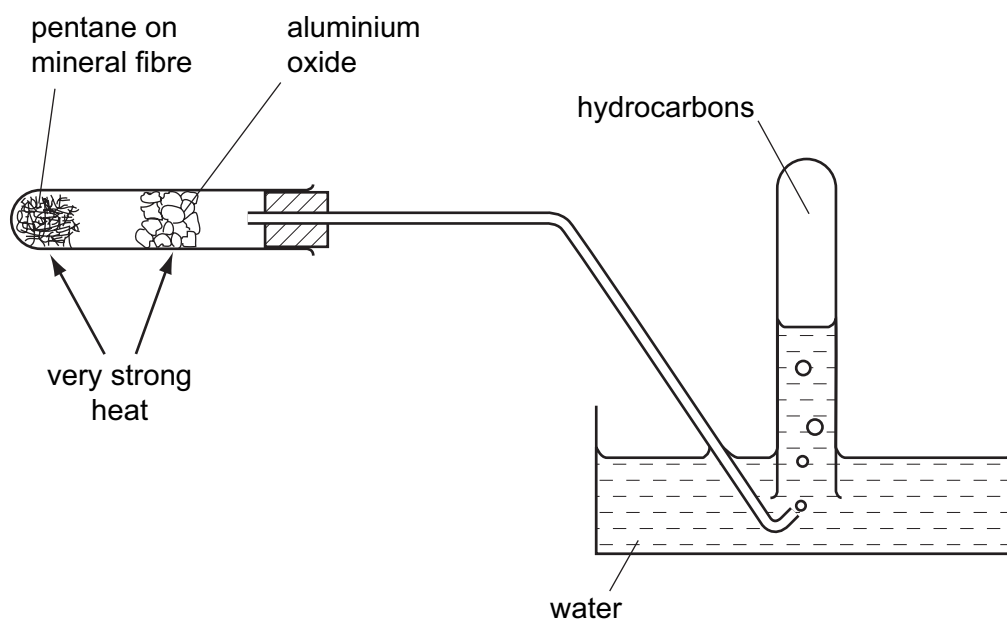

- A CH_4
 B CH_3CH_3
 C $\text{CH}_3\text{CH}_2\text{CH}=\text{CH}_2$
 D $\text{CH}_3(\text{CH}_2)_8\text{CH}_3$

- 24 Mevalonic acid, 3,5-dihydroxy-3-methylpentanoic acid, is involved in cholesterol formation in the body. It is an oil that occurs as a mixture of the two interchanging molecules shown in the diagram.

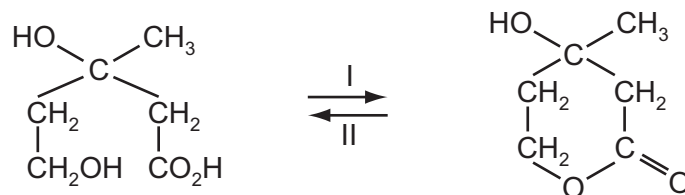

What names are used to describe the pair of interchanging reactions I and II?

- A condensation and addition
 B dehydrogenation and hydrogenation
 C esterification and hydrolysis
 D neutralisation and acidification
- 25 Halogenoalkanes are important molecules in organic synthetic reactions. In particular they undergo a range of nucleophilic reactions.

Which reaction proceeds **only** by an S_N1 mechanism?

- A $\text{CH}_3\text{CH}_2\text{Br} + \text{NH}_3$
 B $\text{CH}_3\text{CH}_2\text{CH}_2\text{I} + \text{OH}^-$
 C $\text{CH}_3\text{CHBrCH}_3 + \text{NH}_3$
 D $(\text{CH}_3)_3\text{CI} + \text{OH}^-$
- 26 An alcohol of molecular formula $\text{C}_4\text{H}_{10}\text{O}_2$ contains two OH groups and has an unbranched carbon atom chain.

On reaction with an excess of hot $\text{MnO}_4^- / \text{H}^+$ this alcohol is converted into a compound of molecular formula $\text{C}_4\text{H}_6\text{O}_4$.

To which two carbon atoms in the chain of the alcohol are the two OH groups attached?

- A 1st and 2nd
 B 1st and 3rd
 C 1st and 4th
 D 2nd and 3rd

27 Compound X

- has the molecular formula $C_{10}H_{14}O$;
- is unreactive towards mild oxidising agents.

What is the structure of the compound formed by dehydration of X?

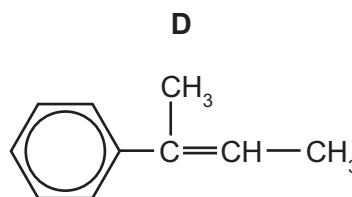
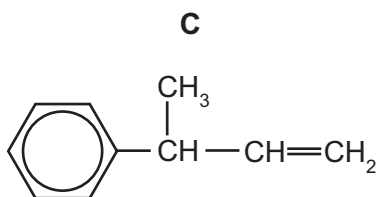
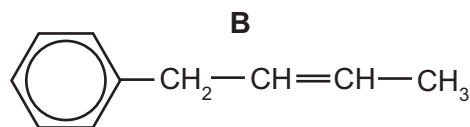
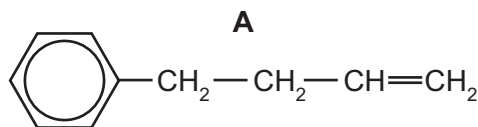

- 28 Ethanal, CH_3CHO , can be reduced using an aqueous methanolic solution of $NaBH_4$ as the reducing agent.

This is a nucleophilic addition reaction.

What could be the first step of this mechanism?

- A** attack of an H^+ ion at the carbon atom of the carbonyl group
B attack of an H^+ ion at the oxygen atom of the carbonyl group
C attack of an H^- ion at the carbon atom of the carbonyl group
D attack of an H^- ion at the oxygen atom of the carbonyl group
- 29 Which compound is both chiral and acidic?

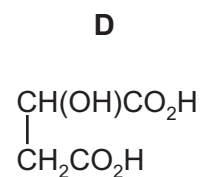
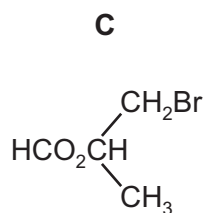
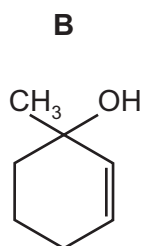
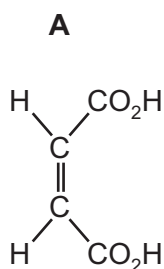

30 Compound **X**, $C_6H_{12}O$, is oxidised by acidified sodium dichromate(VI) to compound **Y**.

Compound **Y** reacts with ethanol in the presence of a little concentrated sulphuric acid to give liquid **Z**.

What is the formula of **Z**?

- A $CH_3(CH_2)_2CH=CHCO_2H$
- B $CH_3(CH_2)_4CH_2COCH_2CH_3$
- C $CH_3(CH_2)_4CO_2CH_2CH_3$
- D $CH_3CH_2CO_2(CH_2)_4CH_3$

Section B

For each of the questions in this section, one or more of the three numbered statements 1 to 3 may be correct.

Decide whether each of the statements is or is not correct (you may find it helpful to put a tick against the statements that you consider to be correct).

The responses **A** to **D** should be selected on the basis of

A	B	C	D
1, 2 and 3 are correct	1 and 2 only are correct	2 and 3 only are correct	1 only is correct

No other combination of statements is used as a correct response.

- 31** For complete combustion, 1 mol of an organic compound **X** was found to require 2.5 mol of molecular oxygen.

Which compounds could be **X**?

- 1 C₂H₅OH
- 2 C₂H₂
- 3 CH₃CHO

- 32** Catalysts are used in many reversible reactions in the chemical industry. Vanadium(V) oxide is used in this way in the Contact process for the formation of SO₃.

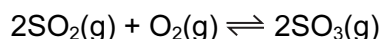

What effect does vanadium(V) oxide have on this equilibrium?

- 1 It speeds up the forward reaction.
- 2 It increases the value of K_p .
- 3 It increases the value of E_a for the reverse reaction.

- 33** Which statements about the properties of a catalyst are correct?

- 1 A catalyst increases the average kinetic energy of the reacting particles.
- 2 A catalyst increases the rate of the reverse reaction.
- 3 A catalyst has no effect on the enthalpy change of the reaction.

The responses **A** to **D** should be selected on the basis of

A	B	C	D
1, 2 and 3 are correct	1 and 2 only are correct	2 and 3 only are correct	1 only is correct

No other combination of statements is used as a correct response.

34 Water is added to anhydrous aluminium chloride to make a 0.1 mol dm^{-3} solution.

Which observations are correct?

- 1 The reaction is endothermic.
- 2 The solution is acidic.
- 3 The solution contains the ion $[\text{Al}(\text{H}_2\text{O})_6]^{3+}$.

35 The electronic structure of the outer shell of the element radium is $7s^2$.

Which statements will be correct for radium within its group?

- 1 The element will decompose water, liberating hydrogen.
- 2 The element will show an oxidation number of +2 in all its compounds.
- 3 Radium has the highest first ionisation energy.

36 When the yellow liquid NCl_3 is stirred into aqueous sodium hydroxide, the reaction that occurs can be represented by the following equation.

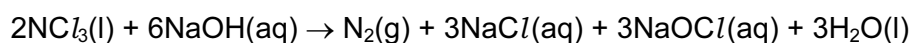

What will be the result of this reaction?

- 1 The nitrogen is oxidised.
- 2 A bleaching solution remains after the reaction.
- 3 The final solution gives a precipitate with acidified silver nitrate.

- 37 Aspirin is a widely-available pain-killer, whose properties have been known for centuries. The structure of aspirin is shown.

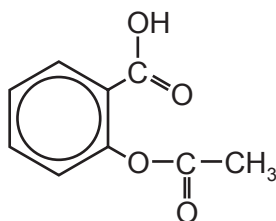

Which functional groups are present in aspirin?

- 1 alcohol
 - 2 carboxylic acid
 - 3 ester
- 38 The structure of monosodium glutamate, a flavour enhancer, is shown.

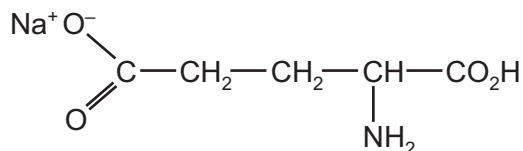

It may be prepared starting from the following compound.

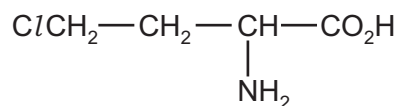

Which set of reagents and reaction conditions could be used to prepare monosodium glutamate?

- 1 Heat under reflux with ethanolic KCN followed by hydrolysis with NaOH(aq).
- 2 Heat with sodium methanoate, $\text{HCO}_2^- \text{Na}^+$.
- 3 Heat under reflux with NaOH(aq).

The responses **A** to **D** should be selected on the basis of

A	B	C	D
1, 2 and 3 are correct	1 and 2 only are correct	2 and 3 only are correct	1 only is correct

No other combination of statements is used as a correct response.

39 The compound cholesterol has the following structure.

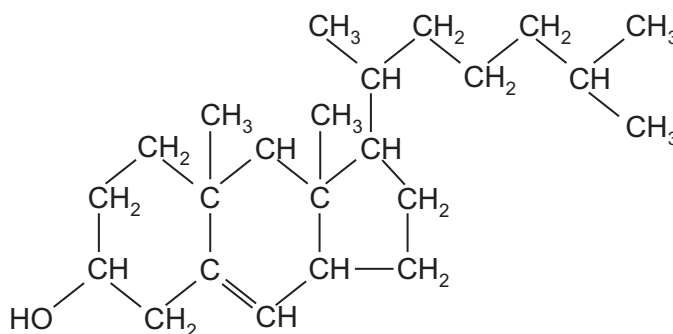

Which statements are correct?

- 1 Cholesterol reacts with a mixture of ethanoic acid and concentrated sulphuric acid.
- 2 Cholesterol reacts with bromine to form a compound which has two new chiral centres.
- 3 Cholesterol is oxidised by acidified sodium dichromate(VI) to form an aldehyde.

40 Ferulic acid is an antioxidant that occurs widely in plants.

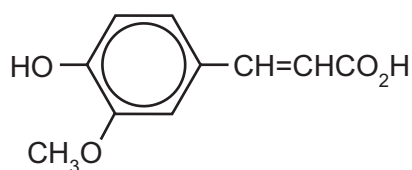

ferulic acid

Which reagents can react with the $-\text{CH}=\text{CHCO}_2\text{H}$ part of the molecule?

- 1 NaOH(aq)
- 2 acidified KMnO_4
- 3 HBr