

Location Entry Codes

As part of CIE's continual commitment to maintaining best practice in assessment, CIE uses different variants of some question papers for our most popular assessments with large and widespread candidature. The question papers are closely related and the relationships between them have been thoroughly established using our assessment expertise. All versions of the paper give assessment of equal standard.

The content assessed by the examination papers and the type of questions is unchanged.

This change means that for this component there are now two variant Question Papers, Mark Schemes and Principal Examiner's Reports where previously there was only one. For any individual country, it is intended that only one variant is used. This document contains both variants which will give all Centres access to even more past examination material than is usually the case.

The diagram shows the relationship between the Question Papers, Mark Schemes and Principal Examiners' Reports that are available.

Question Paper	Mark Scheme	Principal Examiner's Report
Introduction	Introduction	Introduction
First variant Question Paper	First variant Mark Scheme	First variant Principal Examiner's Report
Second variant Question Paper	Second variant Mark Scheme	Second variant Principal Examiner's Report

Who can I contact for further information on these changes?

Please direct any questions about this to CIE's Customer Services team at:

international@cie.org.uk

The titles for the variant items should correspond with the table above, so that at the top of the first page of the relevant part of the document and on the header, it has the words:

- First variant Question Paper / Mark Scheme / Principal Examiner's Report

or

- Second variant Question Paper / Mark Scheme / Principal Examiner's Report

as appropriate.



UNIVERSITY OF CAMBRIDGE INTERNATIONAL EXAMINATIONS
International General Certificate of Secondary Education

CANDIDATE
NAME

CENTRE
NUMBER

--	--	--	--	--

CANDIDATE
NUMBER

--	--	--	--	--

* 7 2 7 2 4 0 1 6 0 7 *

MATHEMATICS

0580/11, 0581/11

Paper 1 (Core)

October/November 2008

1 hour

Candidates answer on the Question Paper.

Additional Materials: Electronic Calculator Mathematical tables (optional)
 Geometrical Instruments Tracing paper (optional)

SUITABLE FOR HEARING IMPAIRED CANDIDATES

READ THESE INSTRUCTIONS FIRST

Write your Centre number, candidate number and name on all the work you hand in.

Write in dark blue or black pen.

You may use a soft pencil for any diagrams or graphs.

Do not use staples, paper clips, highlighters, glue or correction fluid.

DO NOT WRITE IN ANY BARCODES.

Answer **all** questions.

If working is needed for any question it must be shown below that question.

Electronic calculators should be used.

If the degree of accuracy is not specified in the question, and if the answer is not exact, give the answer to three significant figures. Give answers in degrees to one decimal place.

For π , use either your calculator value or 3.142.

At the end of the examination, fasten all your work securely together.

The number of marks is given in brackets [] at the end of each question or part question.

The total of the marks for this paper is 56.

For Examiner's Use

This document consists of **9** printed pages and **3** blank pages.



- 1 Write down a multiple of 4 and 14 which is less than 30.

Answer [1]

2

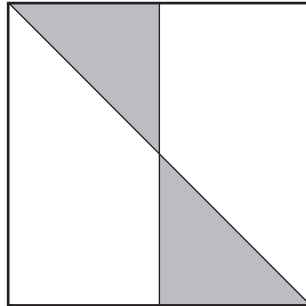

Write down the order of rotational symmetry of the diagram above.

Answer [1]

- 3 On 1st August the level of water in a lake was -15 metres.
A month later the level was 2 metres higher.
Write down the new level of water.

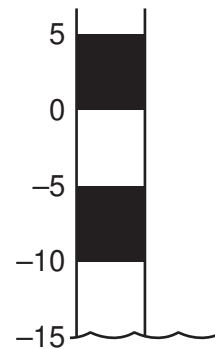

Answer m [1]

- 4 The area of a square is 42.25 cm^2 .
Work out the length of one side of the square.

Answer cm [1]

- 5 Expand the brackets and simplify $5x - 6(3x - 2)$.

Answer [2]

- 6 The scale on a map is 1:250 000.
A road is 4.6 centimetres long on the map.
Calculate the actual length of the road in kilometres.

Answer km [2]

7 > = <

Choose one of the symbols above to complete each of the following statements.

(a) $74\% \dots\dots\dots \frac{5}{7}$ [1]

(b) $\left(\frac{1}{2}\right)^{-3} \dots\dots\dots 8$ [1]

- 8 Juanita changed \$20 into euros . The exchange rate was €1=\$1.2685.
How many euros did she receive?
Give your answer correct to 2 decimal places.

Answer € [2]

- 9 Solve the equation $5x + 2 = 53$.

Answer $x =$ [2]

- 10 The River Nile is 6700 kilometres long, correct to the nearest hundred kilometres.
Complete the statement about the length, L kilometres, of the River Nile.

Answer $< L$, [2]

11

The table below is part of a bus timetable

City centre	11 15	12 30	13 10	13 40
Heatherton	11 25	12 40	13 20	13 50
Rykneld	11 29	12 44	13 24	13 54

- (a) The 11 15 bus left the City centre on time and arrived at Rykneld 2 minutes early.
How many minutes did it take to reach Rykneld?

Answer(a) min [1]

- (b) Paulo walked to the bus stop at Heatherton and arrived at 12 56.
The next bus arrived on time.
How many minutes did Paulo wait for the bus?

Answer(b) min [1]

- 12 The line with equation $y = 2x - k$ passes through the point $(4, 0)$.
Work out the value of k .

Answer $k =$ [2]

- 13 Write 0.00578

- (a) in standard form,

Answer(a) [1]

- (b) correct to 2 significant figures,

Answer(b) [1]

- (c) correct to 2 decimal places.

Answer(c) [1]

- 14** Without using your calculator, work out $\frac{5}{8} \div 3\frac{3}{4}$.
Give your answer as a fraction in its lowest terms.
You must show **all** your working.

Answer

[3]

15

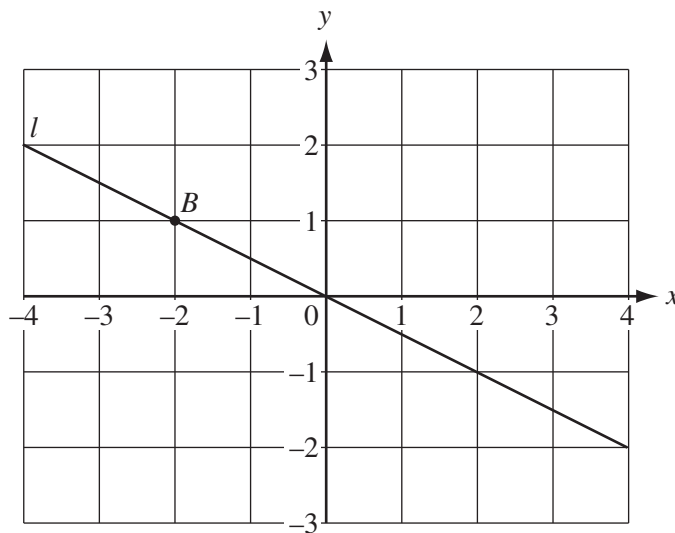

- (a) Mark clearly on the diagram the point with co-ordinates (3, 2) and label it A. [1]
- (b) Write down the co-ordinates of the point B.

Answer(b) (..... ,) [1]

- (c) Find the gradient of the line *l*.

Answer(c) [1]

16 Simplify

(a) $\left(\frac{1}{p}\right)^0$,

Answer(a) [1]

(b) $q^4 \times q^7$,

Answer(b) [1]

(c) $(r^2)^{-3}$.

Answer(c) [1]

17

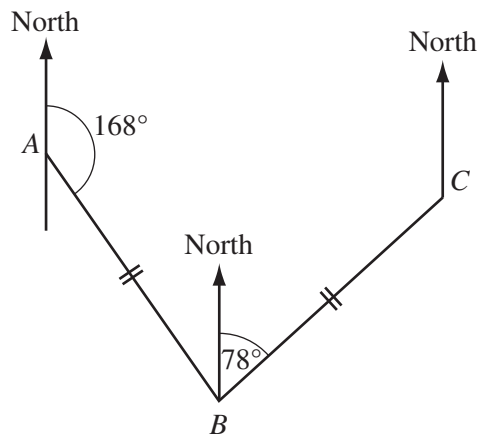
NOT TO
SCALE

The diagram shows the route of a fishing boat.

The boat sails from A to B on a bearing 168° and then from B to C on a bearing 078° . $AB = BC$.(a) Show that angle $ABC = 90^\circ$.

Answer(a)

[1]

(b) Work out the bearing of C from A .

Answer(b) [2]

- 18 (a) Calculate the volume of a cylinder of radius 50 cm and height 138 cm.

Answer(a) cm^3 [2]

- (b) Write your answer to **part (a)** in cubic metres.

Answer(b) m^3 [1]

19

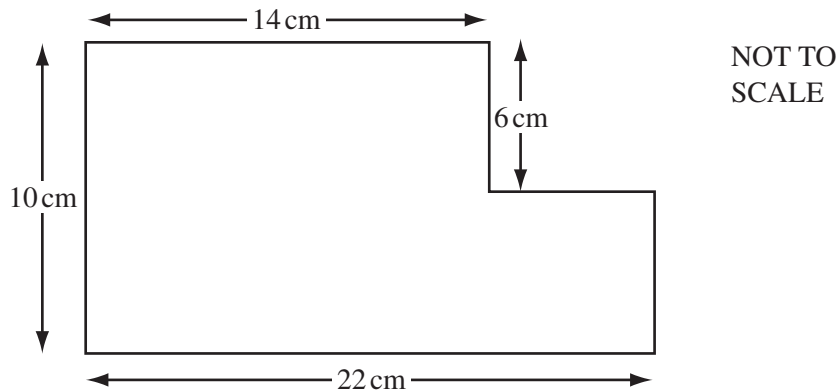

For the shape above, work out

- (a) the perimeter,

Answer(a) cm [2]

- (b) the area.

Answer(b) cm^2 [2]

- 20 (a) 85% of the seeds in a packet will produce red flowers.
One seed is chosen at random.
What is the probability that it will **not** produce a red flower?

Answer(a) [1]

- (b) A box of 15 pencils contains 5 red, 4 yellow and 6 blue pencils.
One pencil is chosen at random from the box.
Find the probability that it is

(i) yellow,

Answer(b)(i) [1]

(ii) yellow or blue,

Answer(b)(ii) [1]

(iii) green.

Answer(b)(iii) [1]

21

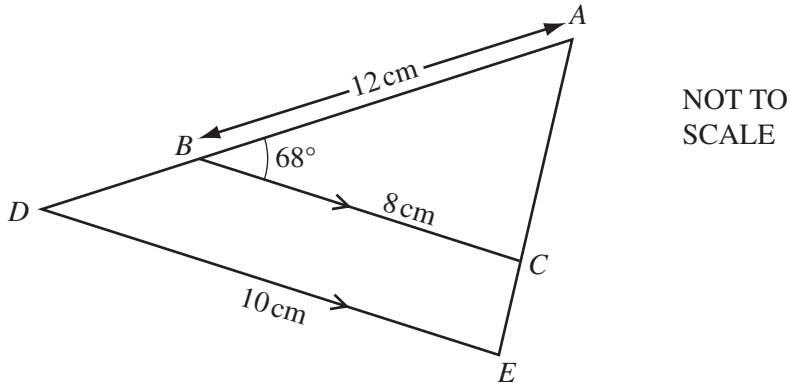

In the diagram BC is parallel to DE .

- (a) Complete the following statement.

Triangle ABC is to triangle ADE . [1]

- (b) $AB = 12$ cm, $BC = 8$ cm and $DE = 10$ cm.
Calculate the length of AD .

Answer(b) cm [2]

- (c) Angle $ABC = 68^\circ$.
Calculate the size of the reflex angle at D .

Answer(c) [2]

- 22 A travel brochure contains 24 pictures from different countries.
The table shows how many pictures there are from each country.

*For
Examiner's
Use*

Country	Number of pictures	Angle in a pie chart
Argentina	6	90°
South Africa	10	150°
Australia	3	
New Zealand		

- (a) Complete the table. [3]
- (b) Complete the pie chart accurately and label the sectors for South Africa, Australia and New Zealand.



[2]

BLANK PAGE

Permission to reproduce items where third-party owned material protected by copyright is included has been sought and cleared where possible. Every reasonable effort has been made by the publisher (UCLES) to trace copyright holders, but if any items requiring clearance have unwittingly been included, the publisher will be pleased to make amends at the earliest possible opportunity.

University of Cambridge International Examinations is part of the Cambridge Assessment Group. Cambridge Assessment is the brand name of University of Cambridge Local Examinations Syndicate (UCLES), which is itself a department of the University of Cambridge.

Second Variant Question Paper



UNIVERSITY OF CAMBRIDGE INTERNATIONAL EXAMINATIONS
International General Certificate of Secondary Education

CANDIDATE
NAME

CENTRE
NUMBER

--	--	--	--	--

CANDIDATE
NUMBER

--	--	--	--



MATHEMATICS

0580/12, 0581/12

Paper 1 (Core)

October/November 2008

1 hour

Candidates answer on the Question Paper.

Additional Materials:

Electronic Calculator
Geometrical Instruments

Mathematical tables (optional)
Tracing paper (optional)

READ THESE INSTRUCTIONS FIRST

Write your Centre number, candidate number and name on all the work you hand in.

Write in dark blue or black pen.

You may use a pencil for any diagrams or graphs.

Do not use staples, paper clips, highlighters, glue or correction fluid.

DO NOT WRITE IN ANY BARCODES.

Answer **all** questions.

If working is needed for any question it must be shown below that question.

Electronic calculators should be used.

If the degree of accuracy is not specified in the question, and if the answer is not exact, give the answer to three significant figures. Give answers in degrees to one decimal place

For π , use either your calculator value or 3.142.

At the end of the examination, fasten all your work securely together.

The number of marks is given in brackets [] at the end of each question or part question.

The total of the marks for this paper is 56.

For Examiner's Use

--

This document consists of **9** printed pages and **3** blank pages.



- 1 Write down a multiple of 9 and 12 which is less than 40.

Answer [1]

2

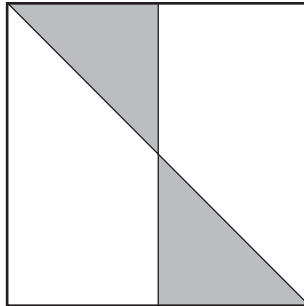

Write down the order of rotational symmetry of the diagram above.

Answer [1]

- 3 On 1st August the level of water in a lake was -15 metres.
A month later the level was 2 metres higher.
Write down the new level of water.

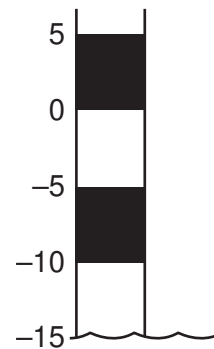

Answer m [1]

- 4 The area of a square is 54.76 cm^2 .
Work out the length of one side of the square.

Answer cm [1]

- 5 Expand the brackets and simplify $3x - 5(4x - 2)$.

Answer [2]

- 6 The scale on a map is 1:250 000.
A road is 3.8 centimetres long on the map.
Calculate the actual length of the road in kilometres.

Answer km [2]

- 7 > = <

Choose one of the symbols above to complete each of the following statements.

(a) 74% $\frac{5}{7}$ [1]

(b) $\left(\frac{1}{2}\right)^{-3}$ 8 [1]

- 8 Juanita changed \$30 into euros when the exchange rate was €1=\$1.2685.
How many euros did she receive?
Give your answer correct to 2 decimal places.

Answer € [2]

- 9 Solve the equation $5x + 1 = 54$.

Answer $x =$ [2]

- 10 The length of the River Nile is 6700 kilometres, correct to the nearest hundred kilometres.
Complete the statement about the length, L kilometres, of the River Nile.

Answer $\leq L <$ [2]

11

City centre	11 15	12 30	13 10	13 40
Heatherton	11 25	12 40	13 20	13 50
Rykneld	11 29	12 44	13 24	13 54

The table above is part of a bus timetable.

- (a) The 11 15 bus left the City centre on time and arrived at Rykneld 2 minutes early.
How many minutes did it take to reach Rykneld?

Answer(a) min [1]

- (b) Paulo walked to the bus stop at Heatherton and arrived at 12 56.
The next bus arrived on time.
How many minutes did Paulo wait for the bus?

Answer(b) min [1]

- 12 The line with equation $y = 2x - k$ passes through the point (4, 0).
Work out the value of k .

Answer $k =$ [2]

- 13 Write 0.00656

- (a) in standard form,

Answer(a) [1]

- (b) correct to 2 significant figures,

Answer(b) [1]

- (c) correct to 2 decimal places.

Answer(c) [1]

- 14** Without using your calculator, work out $\frac{4}{9} \div 6\frac{2}{3}$.
Give your answer as a fraction in its lowest terms.
You must show **all** your working.

Answer

[3]

15

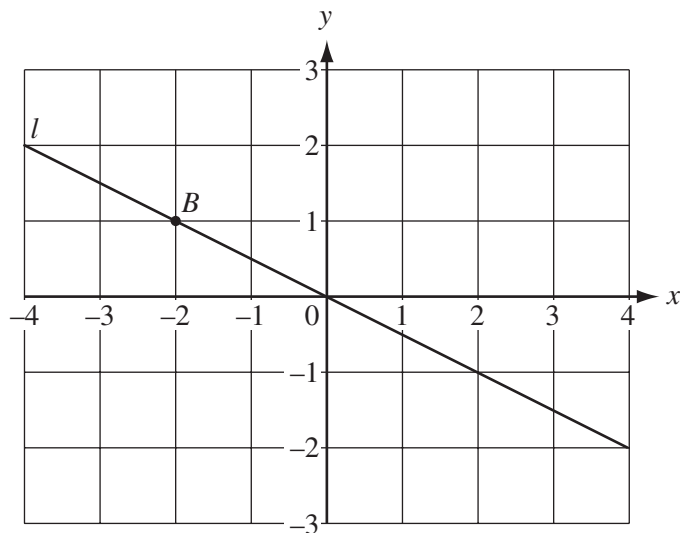

- (a) Mark clearly on the diagram the point with co-ordinates (3, 2) and label it *A*. [1]
- (b) Write down the co-ordinates of the point *B*.

Answer(b) (..... ,) [1]

- (c) Find the gradient of the line *l*.

Answer(c) [1]

16 Simplify

(a) $\left(\frac{1}{p}\right)^0$,

Answer(a) [1]

(b) $q^3 \times q^5$,

Answer(b) [1]

(c) $(r^4)^{-2}$.

Answer(c) [1]

17

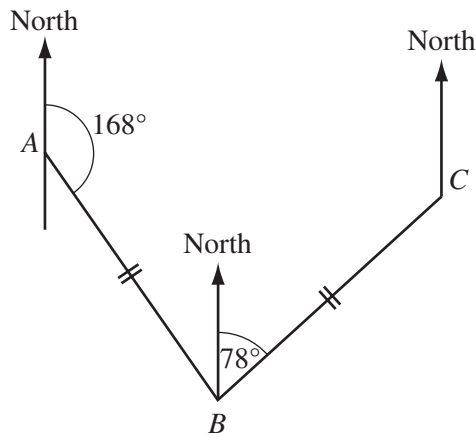
NOT TO
SCALE

The diagram shows the route of a fishing boat.

The boat sails from A to B on a bearing 168° and then from B to C on a bearing 078° . $AB = BC$.(a) Show that angle $ABC = 90^\circ$.

Answer(a)

[1]

(b) Work out the bearing of C from A .

Answer(b) [2]

- 18 (a) Calculate the volume of a cylinder of radius 60 cm and height 129 cm.

Answer(a) cm^3 [2]

- (b) Write your answer to **part (a)** in cubic metres.

Answer(b) m^3 [1]

19

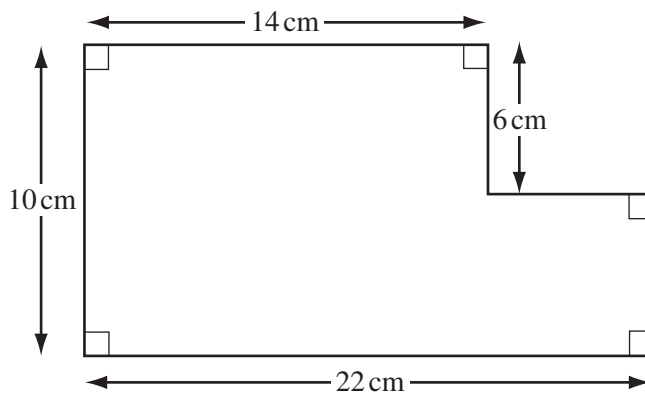

NOT TO
SCALE

For the shape above, work out

- (a) the perimeter,

Answer(a) cm [2]

- (b) the area.

Answer(b) cm^2 [2]

- 20 (a) 85% of the seeds in a packet will produce red flowers.
One seed is chosen at random.
What is the probability that it will **not** produce a red flower?

Answer(a) [1]

- (b) A box of 15 pencils contains 5 red, 4 yellow and 6 blue pencils.
One pencil is chosen at random from the box.
Find the probability that it is

(i) yellow,

Answer(b)(i) [1]

(ii) yellow or blue,

Answer(b)(ii) [1]

(iii) green.

Answer(b)(iii) [1]

21

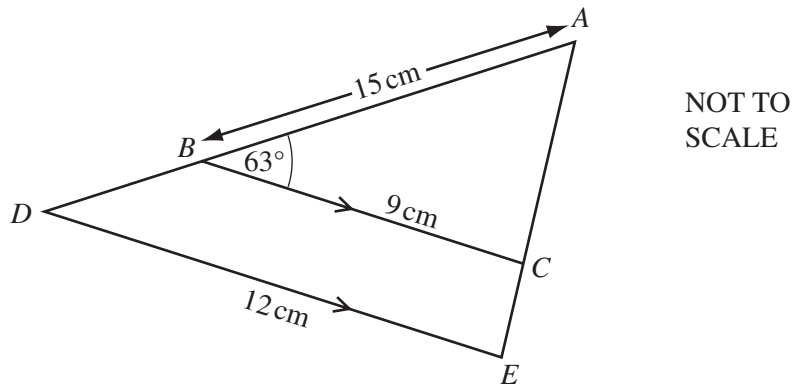

In the diagram BC is parallel to DE .

- (a) Complete the following statement.

Triangle ABC is to triangle ADE . [1]

- (b) $AB = 15$ cm, $BC = 9$ cm and $DE = 12$ cm.
Calculate the length of AD .

Answer(b) cm [2]

- (c) Angle $ABC = 63^\circ$.
Calculate the size of the reflex angle at D .

Answer(c) [2]

- 22 A travel brochure contains 24 pictures from different countries.
The table shows how many pictures there are from each country.

*For
Examiner's
Use*

Country	Number of pictures	Angle in a pie chart
Argentina	6	90°
South Africa	10	150°
Australia	3	
New Zealand		

- (a) Complete the table. [3]
- (b) Complete the pie chart accurately and label the sectors for South Africa, Australia and New Zealand.

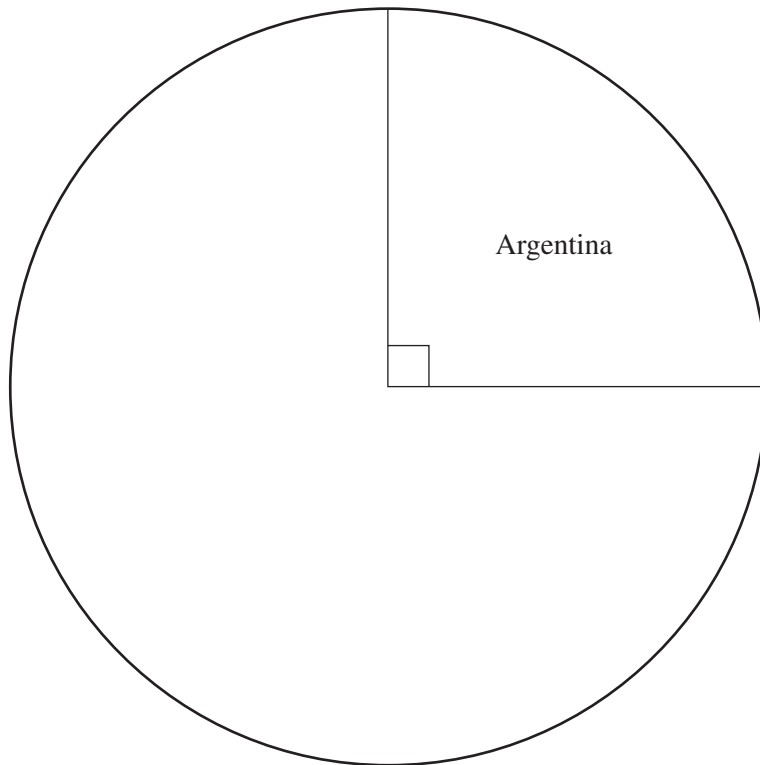

[2]

BLANK PAGE

Permission to reproduce items where third-party owned material protected by copyright is included has been sought and cleared where possible. Every reasonable effort has been made by the publisher (UCLES) to trace copyright holders, but if any items requiring clearance have unwittingly been included, the publisher will be pleased to make amends at the earliest possible opportunity.

University of Cambridge International Examinations is part of the Cambridge Assessment Group. Cambridge Assessment is the brand name of University of Cambridge Local Examinations Syndicate (UCLES), which is itself a department of the University of Cambridge.