

UNIVERSITY OF CAMBRIDGE INTERNATIONAL EXAMINATIONS  
International General Certificate of Secondary Education

**PHYSICS**

Paper 3



**0625/03**

October/November 2004

**1 hour 15 minutes**

Candidates answer on the Question Paper.  
No Additional Materials are required.

Candidate  
Name

Centre  
Number

|  |  |  |  |  |
|--|--|--|--|--|
|  |  |  |  |  |
|--|--|--|--|--|

Candidate  
Number

|  |  |  |  |
|--|--|--|--|
|  |  |  |  |
|--|--|--|--|

**READ THESE INSTRUCTIONS FIRST**

Write your Centre number, candidate number and name on all the work you hand in.  
Write in dark blue or black pen in the spaces provided on the Question Paper.  
You may use a soft pencil for any diagrams, graphs or rough working.  
Do not use staples, paper clips, highlighters, glue or correction fluid.

Answer **all** questions.  
At the end of the examination, fasten all your work securely together.  
The number of marks is given in brackets [ ] at the end of each question or part question.  
You may lose marks if you do not show your working or if you do not use appropriate units.

DO NOT WRITE IN THE BARCODE.

DO NOT WRITE IN THE GREY AREAS BETWEEN THE PAGES.

If you have been given a label, look at the details. If any details are incorrect or missing, please fill in your correct details in the space given on this page.

Stick your personal label here, if provided.

| For Examiner's Use |  |
|--------------------|--|
| 1                  |  |
| 2                  |  |
| 3                  |  |
| 4                  |  |
| 5                  |  |
| 6                  |  |
| 7                  |  |
| 8                  |  |
| 9                  |  |
| 10                 |  |
| 11                 |  |
| <b>Total</b>       |  |

This document consists of **15** printed pages and **1** blank page.



- 1 Fig. 1.1 shows the path of one drop of water in the jet from a powerful hose.

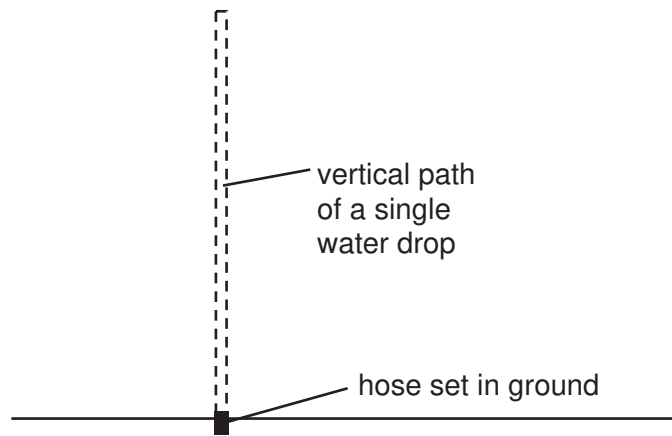

**Fig. 1.1**

Fig. 1.2 is a graph of speed against time for the water drop shown in Fig. 1.1.

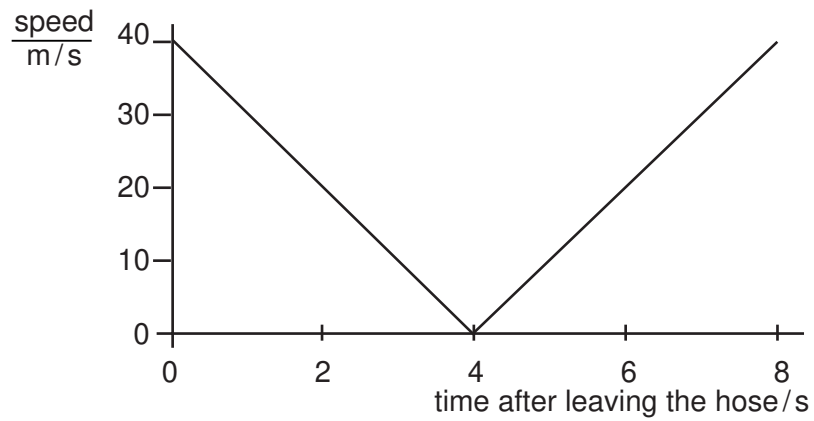

**Fig. 1.2**

- (a) Describe the movement of the water drop in the first 4 s after leaving the hose.

.....

.....

.....[2]

(b) Use Fig. 1.2 to find

(i) the speed of the water leaving the hose,

speed = .....

(ii) the time when the speed of the water is least.

time = .....

[2]

(c) Use values from Fig. 1.2 to calculate the acceleration of the drop as it falls back towards the ground. Show your working.

acceleration = .....[3]

(d) Calculate the greatest distance above the ground reached by the drop.

distance = .....[3]

2 Fig. 2.1 shows a reservoir that stores water.

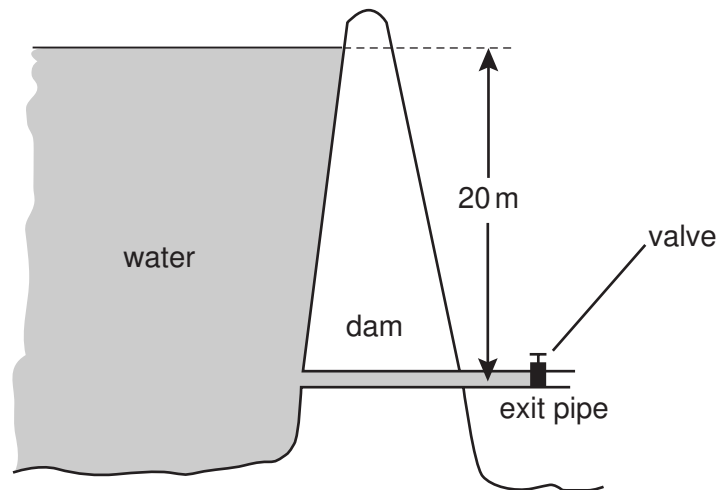

**Fig. 2.1**

- (a) The valve in the exit pipe is closed. The density of water is  $1000 \text{ kg/m}^3$  and the acceleration of free fall is  $10 \text{ m/s}^2$ .  
Calculate the pressure of the water acting on the closed valve in the exit pipe.

pressure = .....[2]

- (b) The cross-sectional area of the pipe is  $0.5 \text{ m}^2$ .  
Calculate the force exerted by the water on the closed valve.

force = .....[2]

- (c) The valve is then opened and water, originally at the surface of the reservoir, finally flows out of the exit pipe. State the energy transformation of this water between the surface of the reservoir and the open end of the pipe.

.....  
.....[2]

3 A scientist needs to find the density of a sample of rock whilst down a mine. He has only a spring balance, a measuring cylinder, some water and some thread.

(a) In the space below, draw two labelled diagrams, one to show the spring balance being used and the other to show the measuring cylinder being used with a suitable rock sample. [2]

(b) The spring balance is calibrated in newtons. State how the mass of the rock sample may be found from the reading of the spring balance.

.....[1]

(c) State the readings that would be taken from the measuring cylinder.

.....  
.....[1]

(d) State how the volume of the rock would be found from the readings.

.....[1]

(e) State in words the formula that would be used to find the density of the sample.

density = [1]

- 4 (a) Fig. 4.1 shows a simple type of thermocouple that has been calibrated to measure temperature.

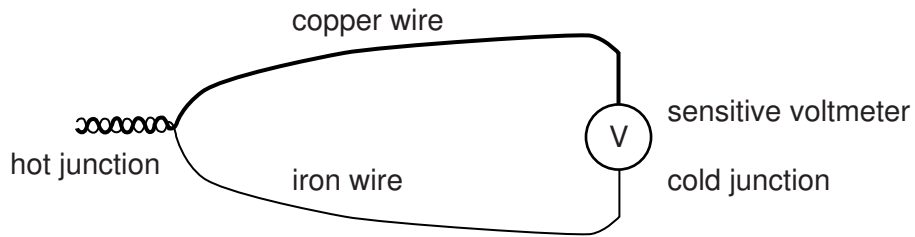

Fig. 4.1

- (i) Describe how the thermocouple could be used to measure the temperature of a beaker of hot water.

.....  
.....  
.....

- (ii) State two situations where a thermocouple would be a good choice of thermometer to measure temperature.

1. ....  
.....  
2. ....  
.....

[4]

- (b) A mercury-in-glass thermometer is placed in an insulated beaker of water at  $60^{\circ}\text{C}$ . The water is heated at a constant rate. The temperature of the water is measured and recorded on the graph shown in Fig. 4.2.

For  
Examiner's  
Use

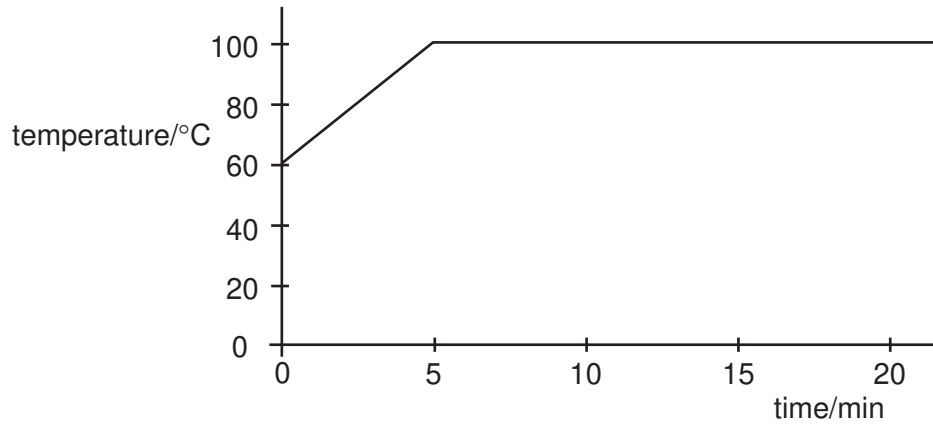

**Fig. 4.2**

State the effect of the heat supplied

- (i) during the period 0 to 5 minutes,

.....

.....

- (ii) during the period 10 to 15 minutes.

.....

.....

[2]

5 (a) Fig. 5.1 shows a sealed box.

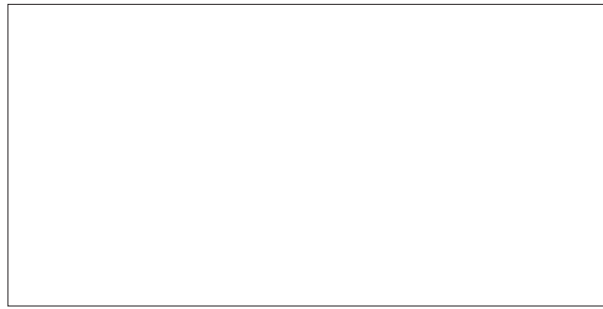

Fig. 5.1

(i) The box contains a large number of air molecules. On Fig. 5.1, draw a possible path of **one** of the air molecules, as it moves inside the box.

(ii) Explain

1 how air molecules in the box create a pressure on the inside walls,

.....  
.....  
.....

2 why this pressure rises as the temperature of the air in the box increases.

.....  
.....  
.....

[5]

(b) Air in a cylinder is compressed slowly, so that the temperature does not rise. The pressure changes from  $2.0 \times 10^5 \text{ Pa}$  to  $5.0 \times 10^5 \text{ Pa}$ . The original volume was  $0.35 \text{ m}^3$ . Calculate the new volume.

volume = .....[3]



6 Fig. 6.1 shows an optical fibre. XY is a ray of light passing along the fibre.

For  
Examiner's  
Use

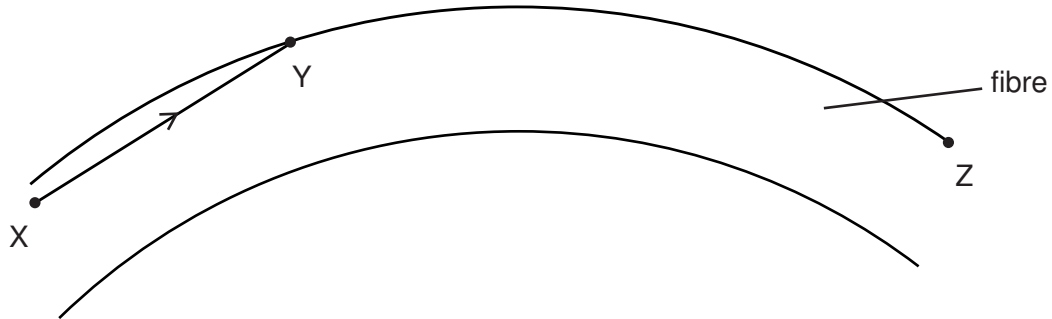

Fig. 6.1

(a) On Fig. 6.1, continue the ray XY until it passes Z. [1]

(b) Explain why the ray does **not** leave the fibre at Y.

.....  
 .....  
 .....[2]

(c) The light in the optical fibre has a wavelength of  $3.2 \times 10^{-7}$  m and is travelling at a speed of  $1.9 \times 10^8$  m/s.

(i) Calculate the frequency of the light.

frequency = .....

(ii) The speed of light in air is  $3.0 \times 10^8$  m/s.  
 Calculate the refractive index of the material from which the fibre is made.

refractive index = .....  
 [4]

7 Fig. 7.1 shows a 12 V battery connected to a number of resistors.

For  
Examiner's  
Use

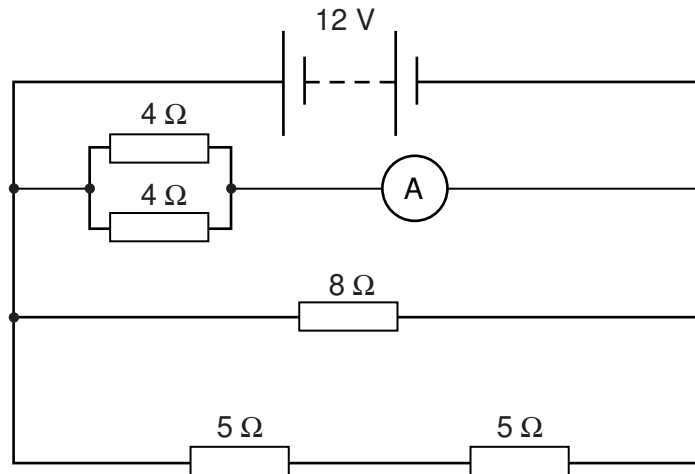

Fig. 7.1

(a) Calculate the current in the 8 Ω resistor.

current = .....[2]

(b) Calculate, for the resistors connected in the circuit, the combined resistance of

(i) the two 5 Ω resistors,

resistance = .....

(ii) the two 4 Ω resistors.

resistance = .....  
[2]

(c) The total current in the two 4 Ω resistors is 6 A.  
Calculate the total power dissipated in the two resistors.

power = .....[2]

(d) What will be the reading on a voltmeter connected across

(i) the two  $4\ \Omega$  resistors,

reading = .....

(ii) one  $5\ \Omega$  resistor?

reading = .....

[2]

(e) The  $8\ \Omega$  resistor is made from a length of resistance wire of uniform cross-sectional area. State the effect on the resistance of the wire of using

(i) the same length of the same material with a greater cross-sectional area,

.....

(ii) a smaller length of the same material with the same cross-sectional area.

.....

[2]

- 8 Fig. 8.1 shows plane waves passing through a gap in a barrier that is approximately equal to the wavelength of the waves.

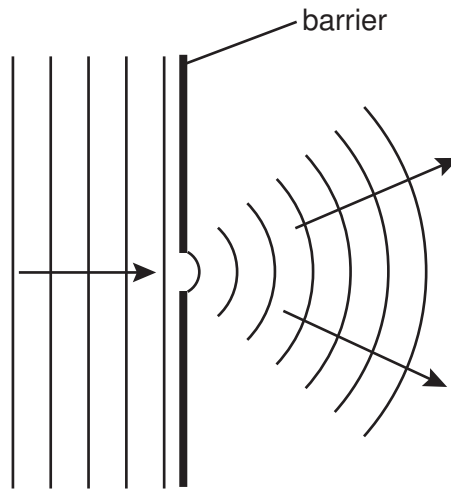

Fig. 8.1

- (a) What is the name given to the wave property shown in Fig. 8.1?

.....[1]

- (b) In the space below, carefully draw the pattern that would be obtained if the gap were increased to six times the wavelength of the waves. [4]

- (c) The effect in Fig. 8.1 is often shown using water waves on the surface of a tank of water. These are transverse waves. Explain what is meant by a *transverse* wave.

.....  
 .....  
 .....[2]

9 (a) An engine on a model railway needs a 6 V a.c. supply. A mains supply of 240 V a.c. is available.

(i) In the space below, draw a labelled diagram of a transformer suitable for producing the required supply voltage.

(ii) Suggest suitable numbers of turns for the coils.

.....  
.....

[4]

(b) The power needed for this model engine is 12 W. Calculate the current taken from the mains when just this engine is in use, assuming that the transformer is 100% efficient.

current = .....[2]

(c) Explain why transformers will only work when connected to an a.c. supply.

.....  
.....  
.....[2]

10 (a) (i) What is the function of a transistor when placed in an electrical circuit?

.....

(ii) Describe the action of a transistor.

.....

.....

.....

[3]

(b) (i) In the space below, draw the symbol for an OR gate. Label the inputs and the output.

[1]

(ii) Describe the action of an OR gate that has two inputs.

.....

.....

.....

[2]

- 11 (a) The decay of a nucleus of radium  ${}^{226}_{88}\text{Ra}$  leads to the emission of an  $\alpha$ -particle and leaves behind a nucleus of radon (Rn).  
In the space below, write an equation to show this decay. [2]

For  
Examiner's  
Use

- (b) In an experiment to find the range of  $\alpha$ -particles in air, the apparatus in Fig. 11.1 was used.

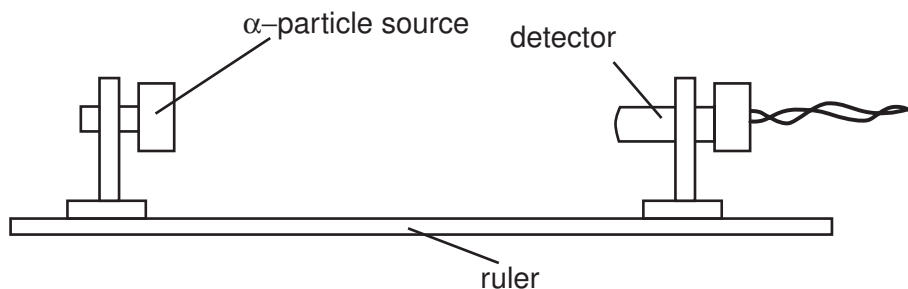

Fig. 11.1

The results of this experiment are shown below.

|                                     |     |     |     |     |     |    |    |    |    |
|-------------------------------------|-----|-----|-----|-----|-----|----|----|----|----|
| count rate / (counts/minute)        | 681 | 562 | 441 | 382 | 317 | 20 | 19 | 21 | 19 |
| distance from source to detector/cm | 1   | 2   | 3   | 4   | 5   | 6  | 7  | 8  | 9  |

- (i) State what causes the count rate 9 cm from the source.  
.....
- (ii) Estimate the count rate that is due to the source at a distance of 2 cm.  
.....
- (iii) Suggest a value for the maximum distance that  $\alpha$ -particles can travel from the source.  
.....
- (iv) Justify your answer to (iii).  
.....  
.....

[4]

---

Every reasonable effort has been made to trace all copyright holders where the publishers (i.e UCLES) are aware that third-party material has been reproduced. The publishers would be pleased to hear from anyone whose rights we have unwittingly infringed.

University of Cambridge International Examinations is part of the University of Cambridge Local Examinations Syndicate (UCLES), which is itself a department of the University of Cambridge.