

UNIVERSITY OF CAMBRIDGE INTERNATIONAL EXAMINATIONS
International General Certificate of Secondary Education

PHYSICS

0625/01

Paper 1 Multiple Choice

May/June 2006

45 minutes

Additional Materials: Multiple Choice Answer Sheet
Soft clean eraser
Soft pencil (type B or HB is recommended)

READ THESE INSTRUCTIONS FIRST

Write in soft pencil.

Do not use staples, paper clips, highlighters, glue or correction fluid.

Write your name, Centre number and candidate number on the Answer Sheet in the spaces provided unless this has been done for you.

There are **forty** questions on this paper. Answer **all** questions. For each question there are four possible answers **A, B, C** and **D**.

Choose the **one** you consider correct and record your choice in **soft pencil** on the separate Answer Sheet.

Read the instructions on the Answer Sheet very carefully.

Each correct answer will score one mark. A mark will not be deducted for a wrong answer.

Any rough working should be done in this booklet.

This document consists of **16** printed pages.



- 1 A measuring cylinder contains some water. When a stone is put in the water, the level rises.

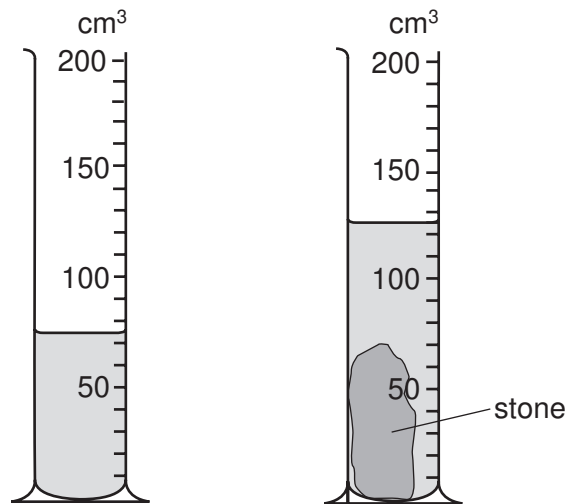

What is the volume of the stone?

- A 50 cm³ B 70 cm³ C 75 cm³ D 125 cm³
- 2 The graph represents the movement of a body accelerating from rest.

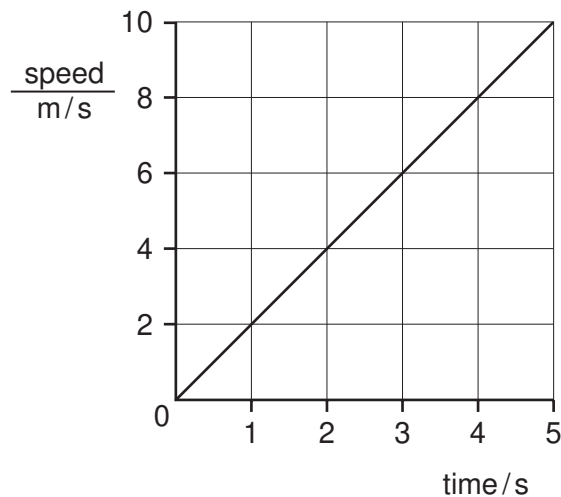

After 5 seconds how far has the body moved?

- A 2 m B 10 m C 25 m D 50 m
- 3 A child is standing on the platform of a station, watching the trains.

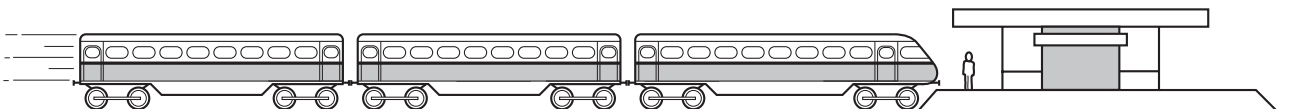

A train travelling at 30 m/s takes 3 s to pass the child.

What is the length of the train?

- A 10 m B 30 m C 90 m D 135 m

- 4 Below are four statements about the effects of forces on objects.

Three of the statements are correct.

Which statement is **incorrect**?

- A** A force can change the length of an object.
B A force can change the mass of an object.
C A force can change the shape of an object.
D A force can change the speed of an object.
- 5 A simple balance has two pans suspended from the ends of arms of equal length. When it is balanced, the pointer is at 0.

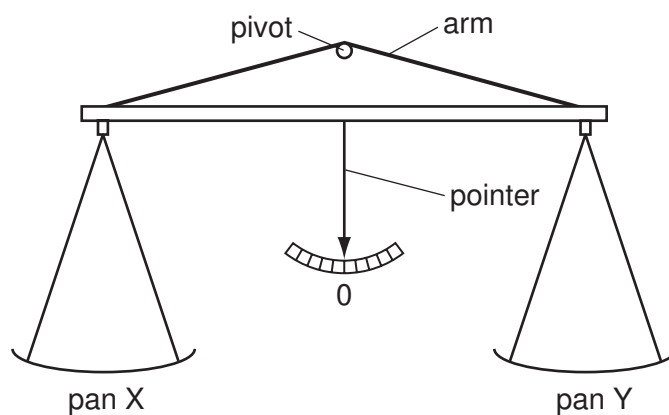

Four masses (in total) are placed on the pans, with one or more on pan X and the rest on pan Y.

Which combination of masses can be used to balance the pans?

- A** 1 g, 1 g, 5 g, 10 g
B 1 g, 2 g, 2 g, 5 g
C 2 g, 5 g, 5 g, 10 g
D 2 g, 5 g, 10 g, 10 g
- 6 A person measures the length, width, height and mass of a rectangular metal block.
- Which of these measurements are needed in order to calculate the density of the metal?
- A** mass only
B height and mass only
C length, width and height only
D length, width, height and mass

7 Two forces act on an object.

In which situation is it **impossible** for the object to be in equilibrium?

- A The two forces act in the same direction.
- B The two forces act through the same point.
- C The two forces are of the same type.
- D The two forces are the same size.

8 The diagram shows four models of buses placed on different ramps.

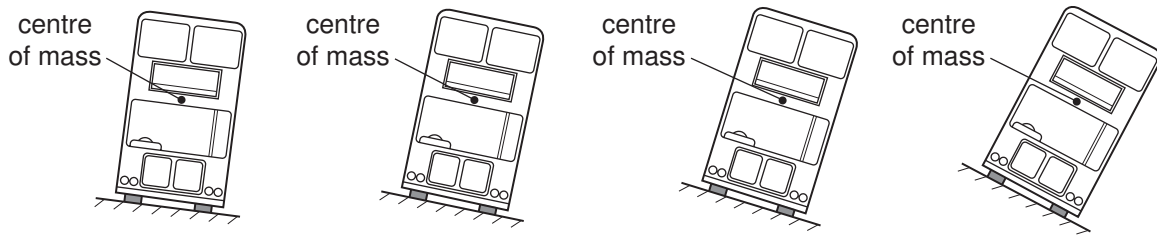

How many of these models will fall over?

- A 1
- B 2
- C 3
- D 4

9 Which form of energy do we receive directly from the Sun?

- A chemical
- B light
- C nuclear
- D sound

10 A labourer on a building site lifts a heavy concrete block onto a lorry. He then lifts a light block the same distance in the same time.

Which of the following is true?

	work done in lifting the blocks	power exerted by labourer
A	less for the light block	less for the light block
B	less for the light block	the same for both blocks
C	more for the light block	more for the light block
D	the same for both blocks	more for the light block

11 The diagram shows a thick sheet of glass.

Which edge must it stand on to cause the greatest pressure?

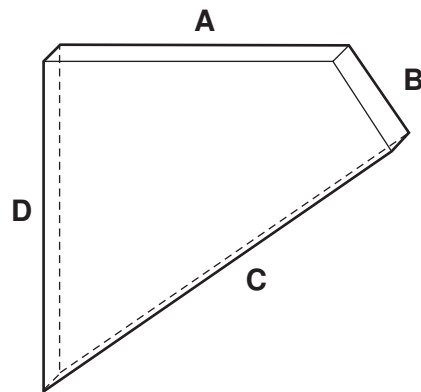

12 A manometer is being used to measure the pressure of the gas inside a tank. A, B, C and D show the manometer at different times.

At which time is the gas pressure inside the tank greatest?

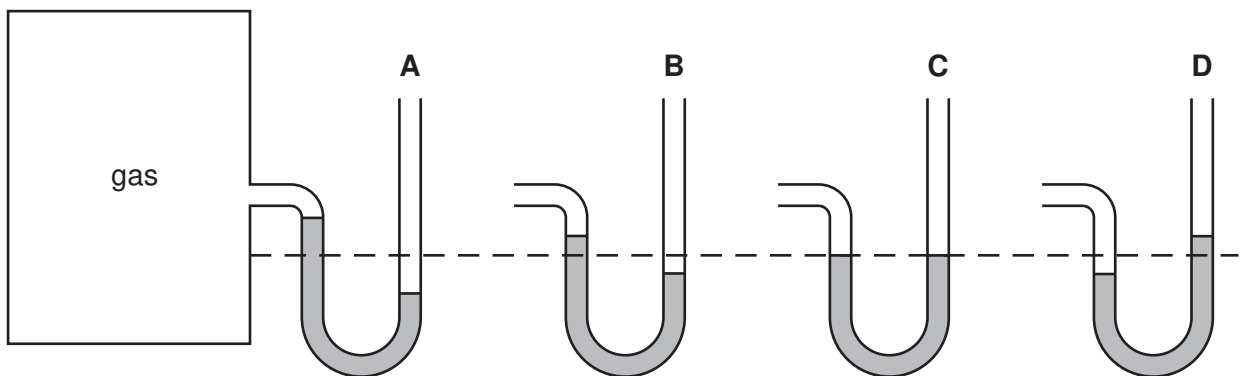

13 Brownian motion is seen by looking at smoke particles through a microscope.

How do the smoke particles move in Brownian motion?

- A all in the same direction
- B at random
- C in circles
- D vibrating about fixed points

- 14 Driving a car raises the temperature of the tyres.

This causes the pressure of the air in the tyres to increase.

Why is this?

- A Air molecules break up to form separate atoms.
 - B Air molecules expand with the rise in temperature.
 - C The force between the air molecules increases.
 - D The speed of the air molecules increases.
- 15 To mark a temperature scale on a thermometer, fixed points are needed.

Which is a fixed point?

- A the bottom end of the thermometer tube
 - B the top end of the thermometer tube
 - C the temperature of pure melting ice
 - D the temperature of pure warm water
- 16 Four blocks, made of different materials, are each given the same quantity of internal (heat) energy.

Which block has the greatest thermal capacity?

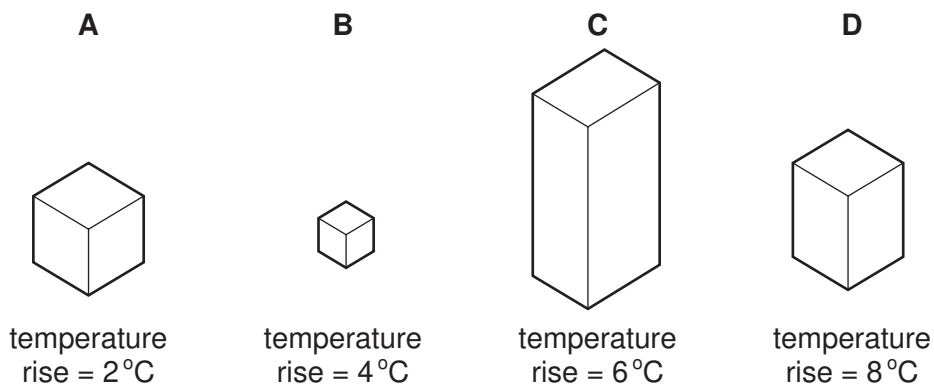

17 A long thin bar of copper is heated evenly along its length.

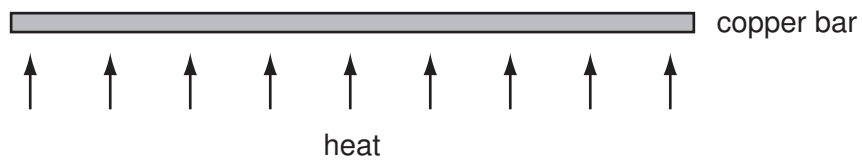

What happens to the bar?

- A It becomes lighter.
- B It becomes longer.
- C It becomes shorter.
- D It bends at the ends.

18 A beaker contains water at room temperature.

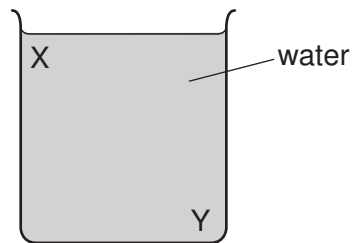

How could a convection current be set up in the water?

- A cool the water at X
- B cool the water at Y
- C stir the water at X
- D stir the water at Y

- 19 Two plastic cups are placed one inside the other. Hot water is poured into the inner cup and a lid is put on top as shown.

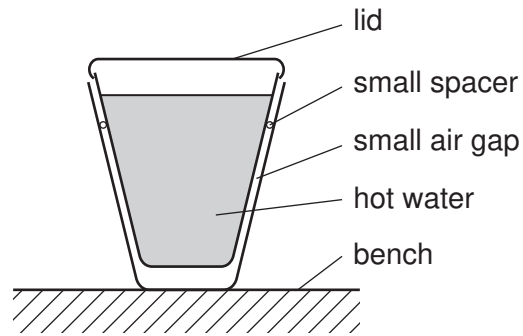

Which statement is correct?

- A Heat loss by radiation is prevented by the small air gap.
 - B No heat passes through the sides of either cup.
 - C The bench is heated by convection from the bottom of the outer cup.
 - D The lid is used to reduce heat loss by convection.
- 20 Which is the best description of the speed of a water wave?
- A the distance between one wave crest and the next
 - B the distance between the crest of a wave and a trough
 - C the distance that a particle of water moves up and down in one second
 - D the distance that a wavefront moves along the surface in one second

21 Water waves travel more slowly in shallow water than in deep water.

Which diagram shows what will happen to plane waves in deep water when they enter shallow water?

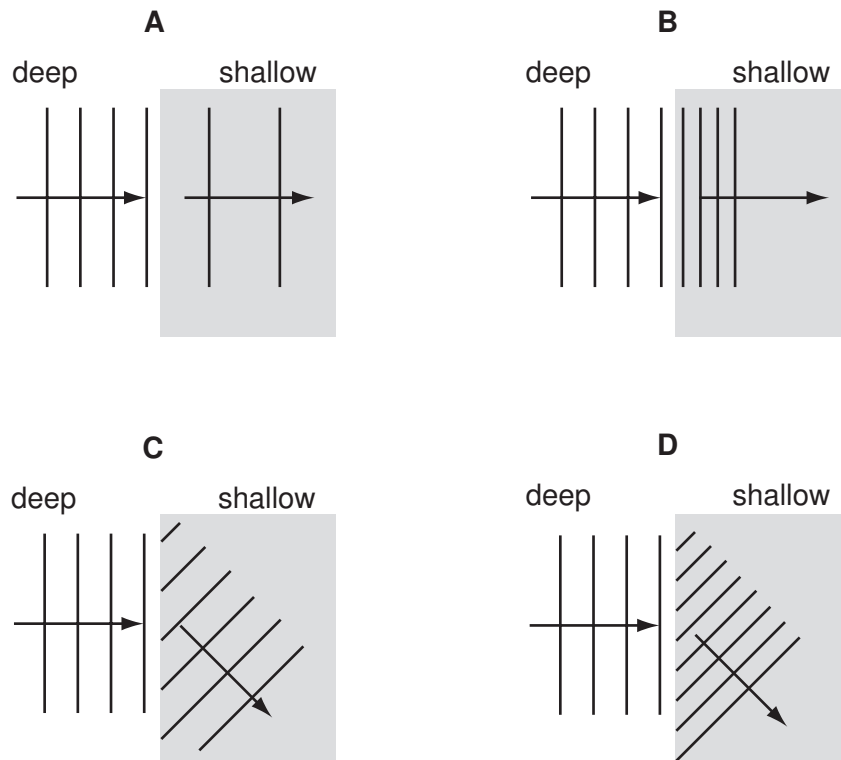

22 A ray of light passes through a window.

Which path does it take?

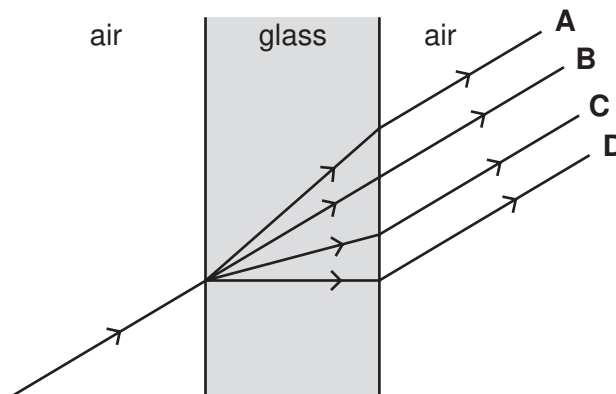

- 23 The diagram shows the image of a clock in a plane mirror.

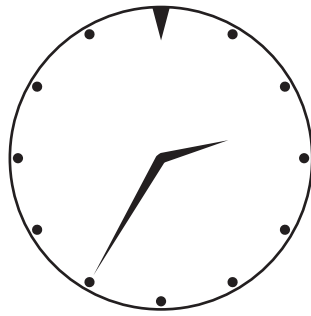

What time is shown?

- A 02:25 B 02:35 C 09:25 D 09:35
- 24 The diagram shows a man standing at X who shouts to a man standing at Y.

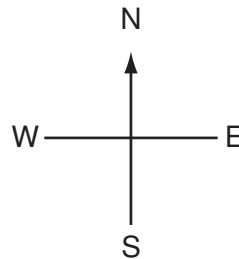

The man's voice will be heard sooner and more clearly if the wind is blowing towards the

- A north.
 B south.
 C east.
 D west.
- 25 Sounds are made by vibrating objects. A certain object vibrates but a person nearby cannot hear any sound.

Which statement might explain why nothing is heard?

- A The amplitude of the sound waves is too large.
 B The frequency of the vibration is too high.
 C The sound waves are transverse.
 D The speed of the sound waves is too high.

26 A student investigates which end of a magnetic compass needle is attracted to a bar magnet.

What does the investigation show?

- A Both ends of the compass needle are attracted by the north pole of the magnet.
- B Both ends of the compass needle are attracted by the south pole of the magnet.
- C One end of the compass needle is attracted by the north pole and the other end by the south pole.
- D The compass needle is not attracted by either end of the magnet.

27 From which materials are the coil and the core of an electromagnet made?

	coil	core
A	copper	copper
B	copper	iron
C	iron	copper
D	iron	iron

28 What are the symbols used for the units of current and resistance?

	unit of current	unit of resistance
A	A	W
B	A	Ω
C	V	W
D	V	Ω

29 When a plastic comb is placed next to a small piece of aluminium foil hanging from a nylon thread, the foil is repelled by the comb.

Why is this?

- A The comb is charged and the foil is uncharged.
- B The comb is uncharged and the foil is charged.
- C The comb and the foil have charge of opposite signs.
- D The comb and the foil have charge of the same sign.

30 Which symbol represents an electrical component used to store energy?

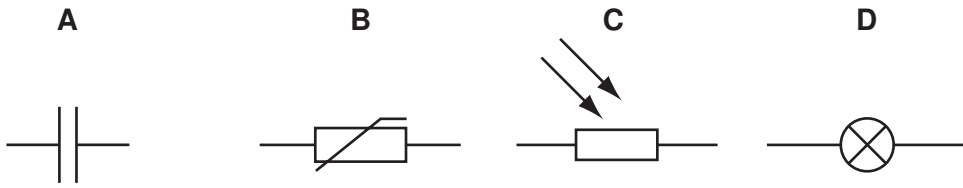

31 Four lamps and four switches are connected to a power supply as shown in the circuit diagram.

When all the switches are closed, all the lamps are lit.

When one of the switches is then opened, only **one** lamp goes out.

Which switch is opened?

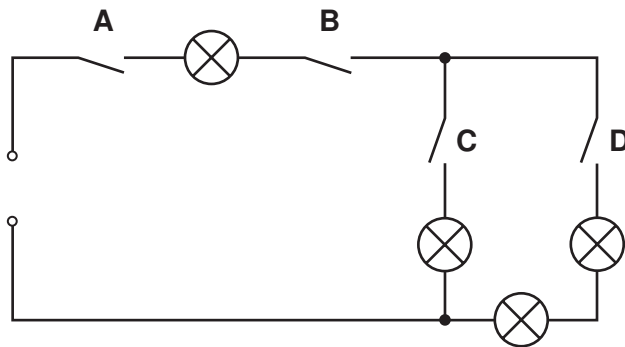

32 Four resistors and an ammeter are connected to a battery as shown.

The ammeter reads 2 A.

Which of the four labelled points in the circuit is the only one where the current is less than 2 A?

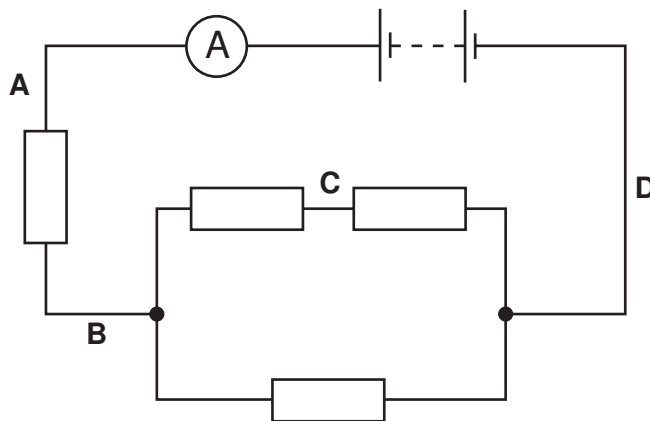

- 33 Why is a fuse used in an electrical circuit in a house?
- A to increase the circuit resistance
 - B to keep the power used to a minimum value
 - C to prevent a short-circuit from occurring
 - D to stop the cables from carrying too much current
- 34 An electric power tool is being used outdoors in a shower of rain.

What is the greatest hazard to the user?

- A The cable gets hot and causes burns.
 - B The circuit-breaker cuts off the current.
 - C The current passes through water and causes a shock.
 - D The tool rusts.
- 35 A current-carrying coil in a magnetic field experiences a turning effect.

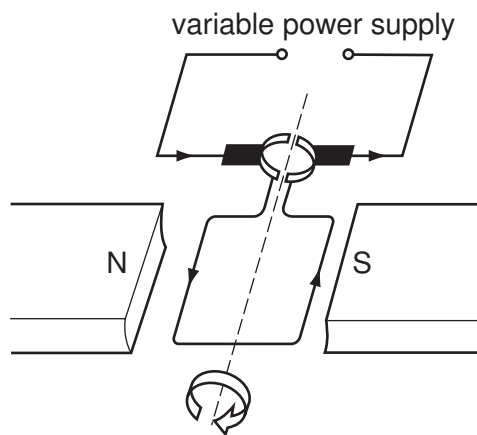

How can the turning effect be increased?

- A increase the number of turns on the coil
- B reduce the size of the current
- C reverse the direction of the magnetic field
- D use thinner wire for the coil

36 A transformer is to be used to produce a 6 V output from a 24 V input.

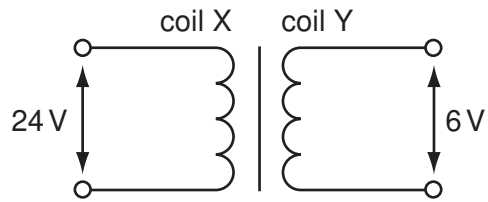

What are suitable numbers of turns for coil X and for coil Y?

	number of turns on coil X	number of turns on coil Y
A	240	60
B	240	240
C	240	960
D	960	60

37 A cathode-ray tube has an anode and an earthed cathode.

Which line in the table shows the charge and the temperature of the **anode**?

	anode charge	anode temperature
A	negative	cool
B	negative	hot
C	positive	cool
D	positive	hot

38 The diagram shows five atoms in a radioactive substance. The atoms each give out an α -particle.

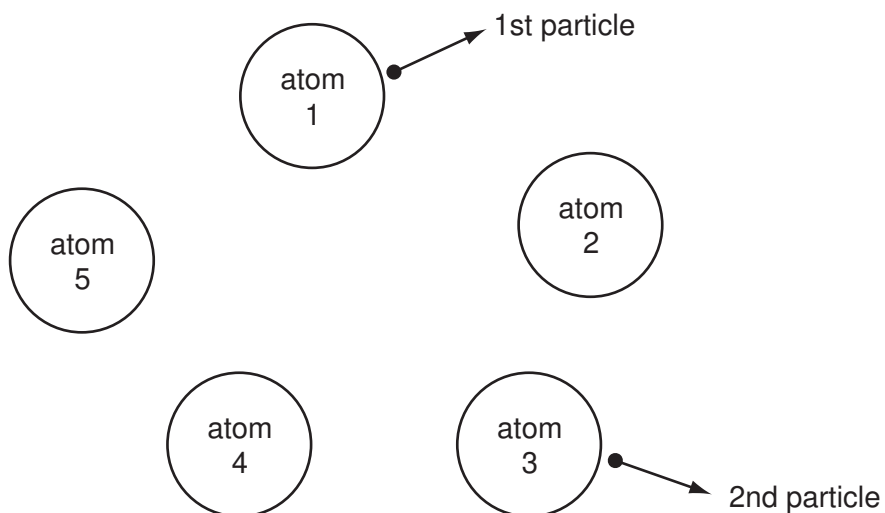

Atom 1 is the first to give out a particle. Atom 3 is the second to give out a particle.

Which atom will give out the next particle?

- A atom 2
 - B atom 4
 - C atom 5
 - D impossible to tell
- 39 A Geiger counter detects radiation from radioactive sources.

A radioactive source is inside a thick aluminium container as shown.

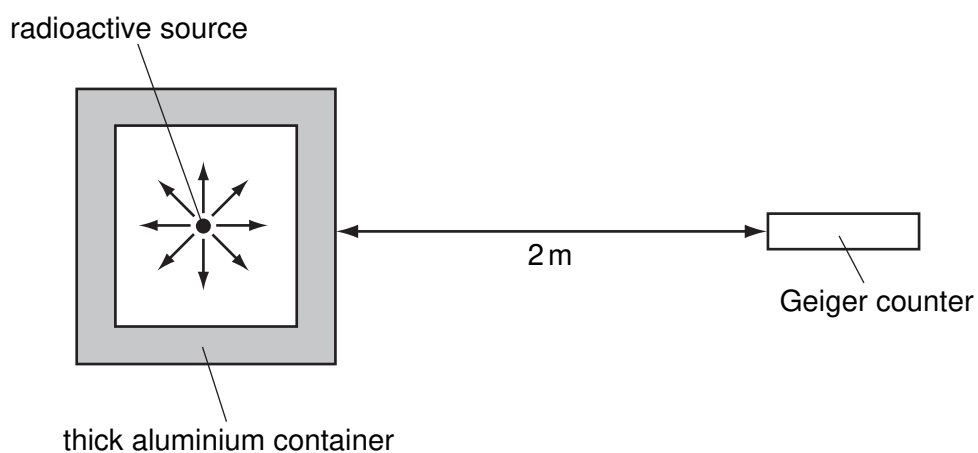

Which type of radiation from this source is being detected?

- A α -particles
- B β -particles
- C γ -rays
- D radio waves

40 The nucleus of a neutral atom of lithium is represented by ${}^7_3\text{Li}$.

How many protons, electrons and neutrons does the atom contain?

	protons	electrons	neutrons
A	7	7	3
B	3	7	3
C	3	4	4
D	3	3	4

Permission to reproduce items where third-party owned material protected by copyright is included has been sought and cleared where possible. Every reasonable effort has been made by the publisher (UCLES) to trace copyright holders, but if any items requiring clearance have unwittingly been included, the publisher will be pleased to make amends at the earliest possible opportunity.

University of Cambridge International Examinations is part of the University of Cambridge Local Examinations Syndicate (UCLES), which is itself a department of the University of Cambridge.