

UNIVERSITY OF CAMBRIDGE INTERNATIONAL EXAMINATIONS  
International General Certificate of Secondary Education

**PHYSICS**

**0625/01**

Paper 1 Multiple Choice

October/November 2006

**45 minutes**

Additional Materials: Multiple Choice Answer Sheet  
Soft clean eraser  
Soft pencil (type B or HB is recommended)

**READ THESE INSTRUCTIONS FIRST**

Write in soft pencil.

Do not use staples, paper clips, highlighters, glue or correction fluid.

Write your name, Centre number and candidate number on the Answer Sheet in the spaces provided unless this has been done for you.

There are **forty** questions on this paper. Answer **all** questions. For each question there are four possible answers **A, B, C** and **D**.

Choose the **one** you consider correct and record your choice in **soft pencil** on the separate Answer Sheet.

**Read the instructions on the Answer Sheet very carefully.**

Each correct answer will score one mark. A mark will not be deducted for a wrong answer.  
Any rough working should be done in this booklet.

This document consists of **18** printed pages and **2** blank pages.



- 1 A ruler is used to measure the length of a nail.

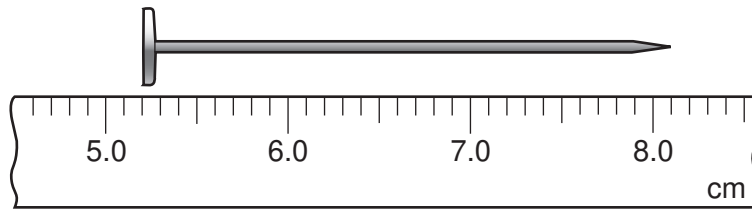

What is the length of the nail?

- A** 1.3 cm      **B** 2.9 cm      **C** 5.2 cm      **D** 8.1 cm
- 2 A cyclist is riding along a road when an animal runs in front of him. The graph shows the cyclist's motion. He sees the animal at P, starts to brake at Q and stops at R.

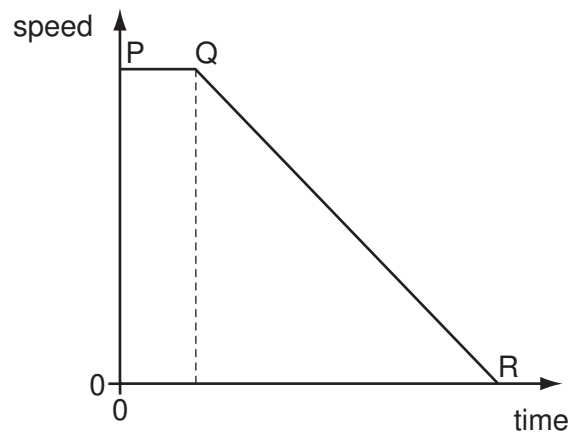

What is used to find the distance travelled after he applies the brakes?

- A** the area under line PQ  
**B** the area under line QR  
**C** the gradient of line PQ  
**D** the gradient of line QR

- 3 A car travels along the route PQRST in 30 minutes.

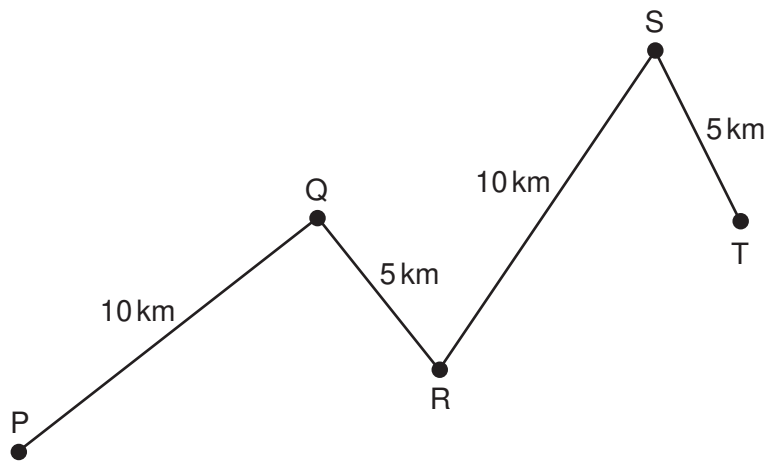

What is the average speed of the car?

- A 10 km/hour
  - B 20 km/hour
  - C 30 km/hour
  - D 60 km/hour
- 4 A newton is a unit of force.

Which quantity is measured in newtons?

- A acceleration
- B density
- C mass
- D weight

5 A student pours liquid into a measuring cylinder.

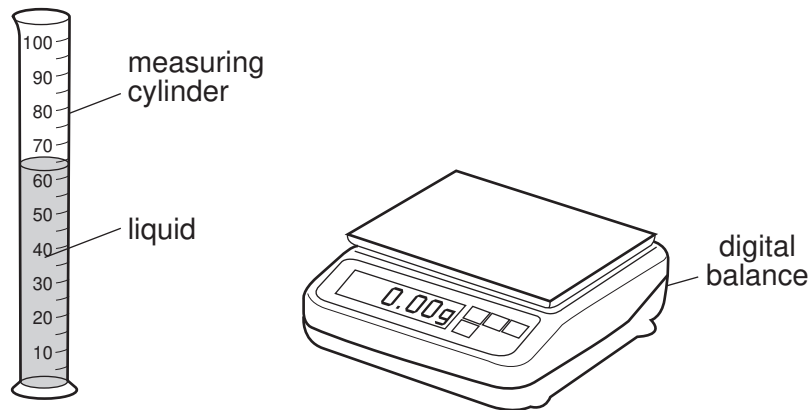

The student records the volume of the liquid from the scale on the measuring cylinder. He then puts the measuring cylinder containing the liquid on a balance and records the mass.

What else needs to be measured before the density of the liquid can be calculated?

- A the depth of the liquid in the measuring cylinder
- B the mass of the empty measuring cylinder
- C the temperature of the liquid in the measuring cylinder
- D the volume of the empty measuring cylinder

- 6 The diagram shows four blocks, each made of glass of density  $2.6 \text{ g/cm}^3$ .

The top of each block has an area of  $1 \text{ cm}^2$ .

Which block has a mass of  $13 \text{ g}$ ?

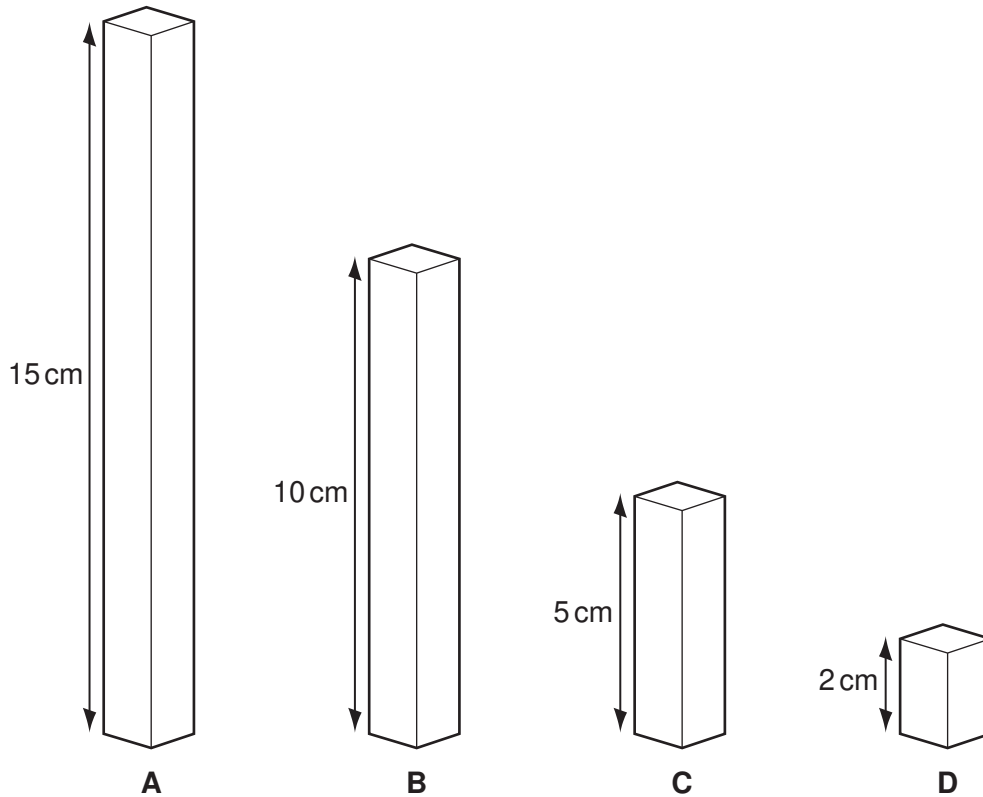

- 7 A heavy beam is resting on two supports, so that there are three forces acting on it.

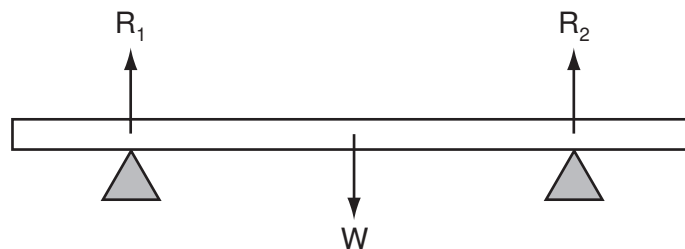

The beam is in equilibrium.

Which statement is correct?

- A All the forces are equal in value.
- B The forces are in one direction and their turning effects are in the opposite direction.
- C The resultant force is zero and the resultant turning effect is zero.
- D The total upward force is twice the total downward force.

- 8 The diagram shows sections of four objects of equal mass. The position of the centre of mass of each object has been marked with a cross.

Which object is the most stable?

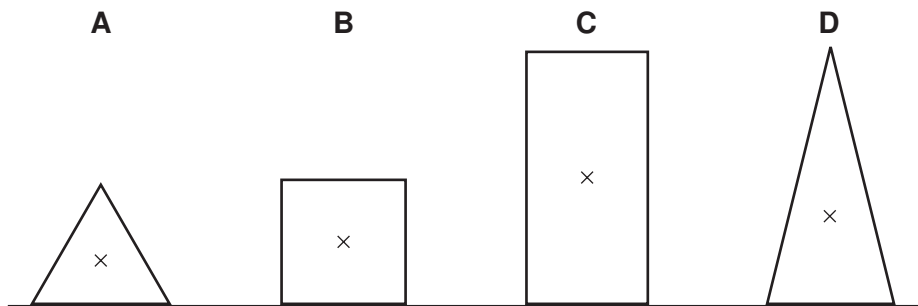

- 9 Which source of energy uses the production of steam to generate electricity?

- A hydroelectric
- B nuclear
- C tides
- D waves

- 10 A cyclist travels down a hill from rest at point X without pedalling.

The cyclist applies his brakes and the cycle stops at point Y.

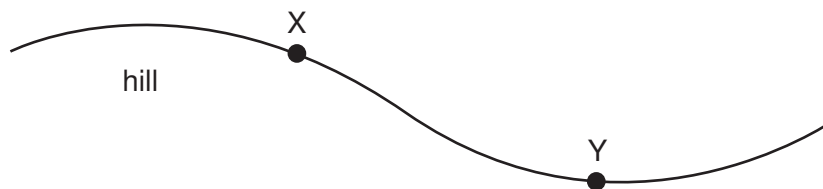

Which energy changes have taken place between X and Y?

- A kinetic  $\rightarrow$  internal (heat)  $\rightarrow$  gravitational potential
- B kinetic  $\rightarrow$  gravitational potential  $\rightarrow$  internal (heat)
- C gravitational potential  $\rightarrow$  internal (heat)  $\rightarrow$  kinetic
- D gravitational potential  $\rightarrow$  kinetic  $\rightarrow$  internal (heat)

11 To prevent a cement mixer sinking into soft ground, the mixer is placed on a large flat board.

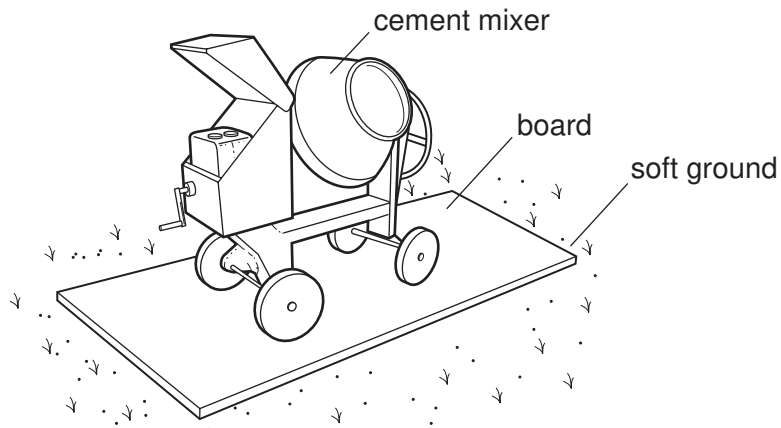

Why does this prevent the mixer sinking?

- A The large area decreases the pressure on the ground.
- B The large area increases the pressure on the ground.
- C The large area decreases the weight on the ground.
- D The large area increases the weight on the ground.

12 The diagram shows a simple mercury barometer.

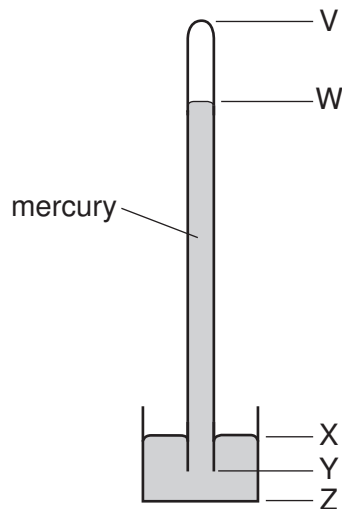

The atmospheric pressure increases.

Which distance increases?

- A VW
- B WY
- C XY
- D XZ

13 A gas cylinder is left outside on a sunny day.

The Sun heats the gas inside the cylinder.

What happens to the gas molecules?

- A They collide less often.
- B They expand.
- C They move closer together.
- D They move more rapidly.

14 Water spilled on the ground on a hot day evaporates.

Which diagram represents the change in arrangement of the particles in the water as it evaporates?

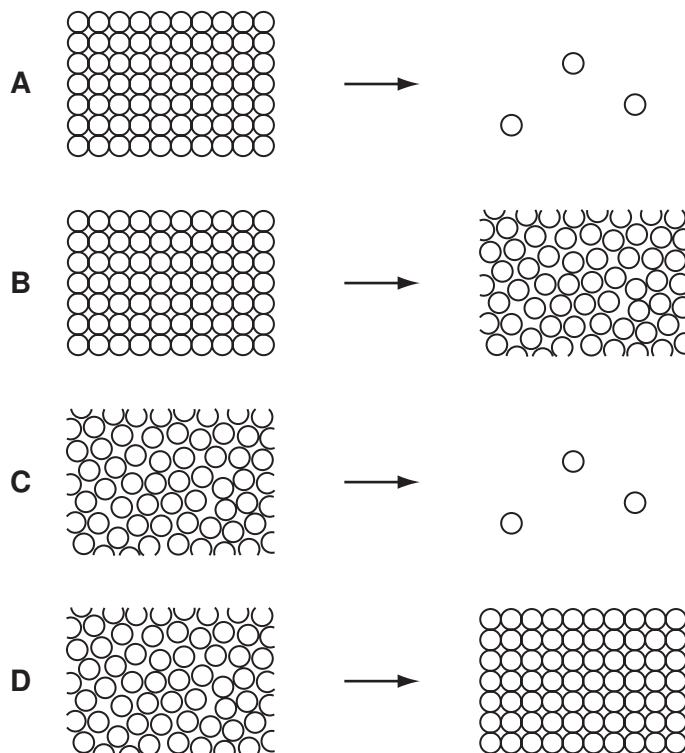



- 15 A block of ice is heated until it has all melted. The water that is produced is then heated until it boils.

Which line in the table states what happens to the temperature of the ice while it is melting, and to the temperature of the water while it is boiling?

	temperature of ice while it is melting	temperature of water while it is boiling
<b>A</b>	increases	increases
<b>B</b>	increases	stays the same
<b>C</b>	stays the same	increases
<b>D</b>	stays the same	stays the same

- 16 A thermometer with no scale is taped to a ruler as shown. When placed in steam, the mercury level rises to 22 cm. When placed in pure melting ice, the mercury level falls to 2 cm.

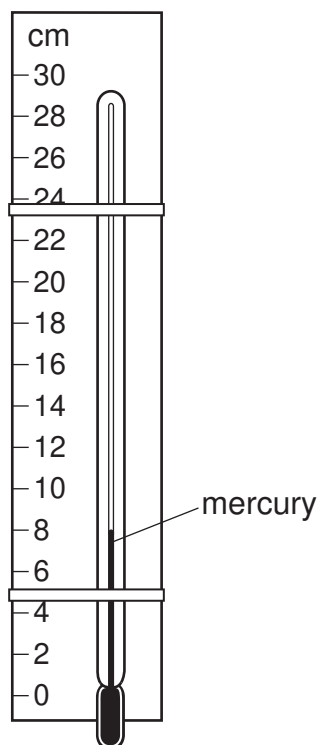

Which temperature is shown by the mercury level in the diagram?

- A** 6°C      **B** 8°C      **C** 30°C      **D** 40°C

17 Which line in the table is correct about conduction and convection?

	conduction	convection
<b>A</b>	can happen in a solid	can happen in a solid
<b>B</b>	can happen in a solid	only happens in fluids
<b>C</b>	only happens in fluids	can happen in a solid
<b>D</b>	only happens in fluids	only happens in fluids

18 A heating element is positioned in a narrow sealed tube of liquid.

What would be the best place to position the heating element in order to obtain the best circulation of the liquid through the tube?

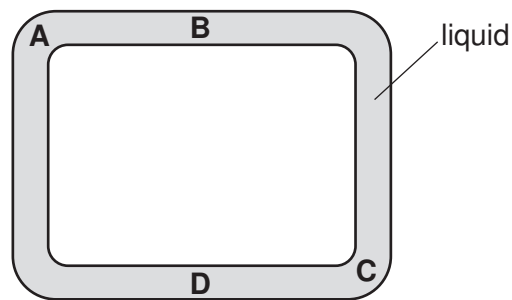

19 In a ripple tank experiment, plane water-waves meet a straight barrier with a wide gap in it.

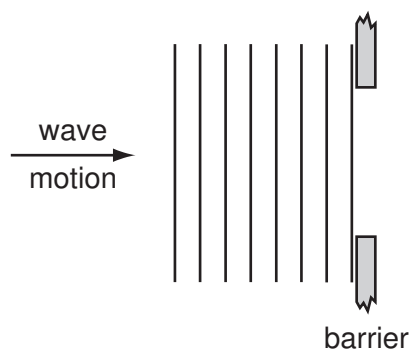

Which diagram shows the wave pattern beyond the barrier?

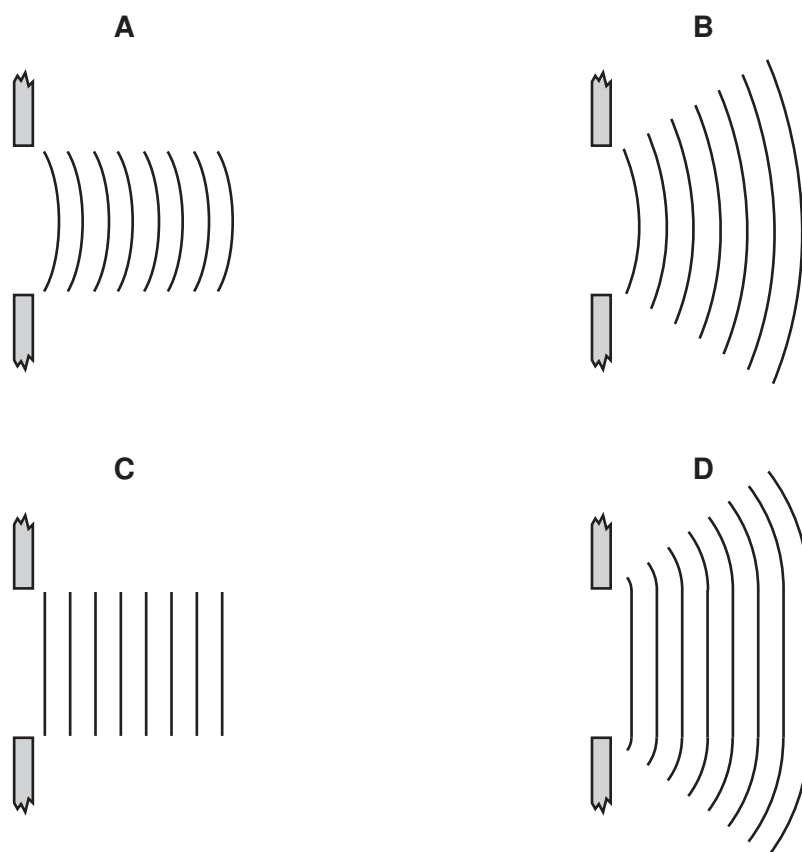

20 The diagram shows a wave.

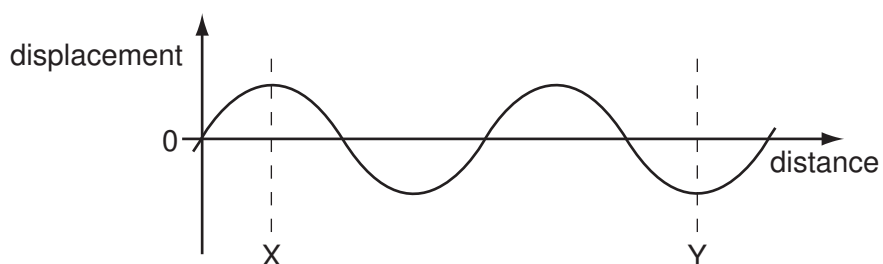

How many wavelengths are there between X and Y?

A  $\frac{2}{3}$

B 1

C  $1\frac{1}{2}$

D 3

21 A parallel beam of light falls on a converging lens.

Which diagram shows what happens to the beam of light?

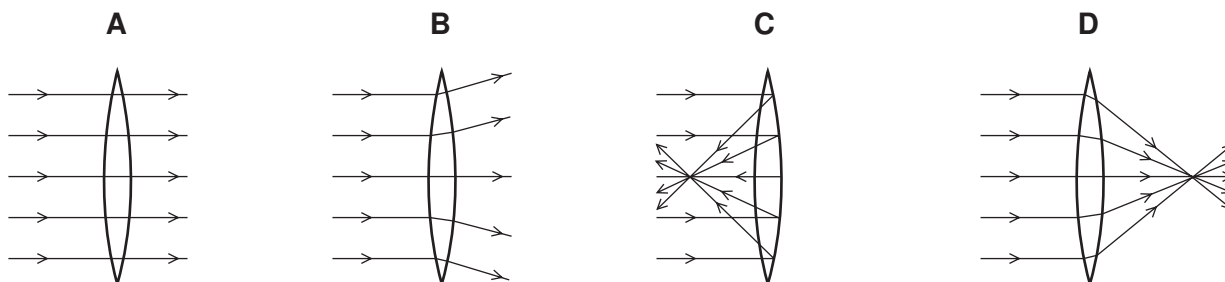

22 The image of a clock face as seen in a plane mirror is shown.

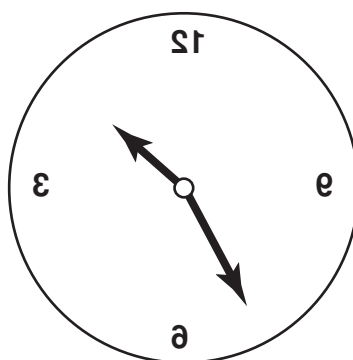

What is the time on the clock?

- A** 1.25      **B** 1.35      **C** 10.25      **D** 10.35

23 A police car with its siren sounding is stationary in heavy traffic. A pedestrian notices that, although the loudness of the sound produced does not change, the pitch varies.

Which line in the table describes the amplitude and the frequency of the sound?

	amplitude	frequency
<b>A</b>	constant	varying
<b>B</b>	constant	constant
<b>C</b>	varying	constant
<b>D</b>	varying	varying

- 24 A sports field is next to a large school building. At the far side of the sports field, a student sees a groundsman hammer a pole into the ground.

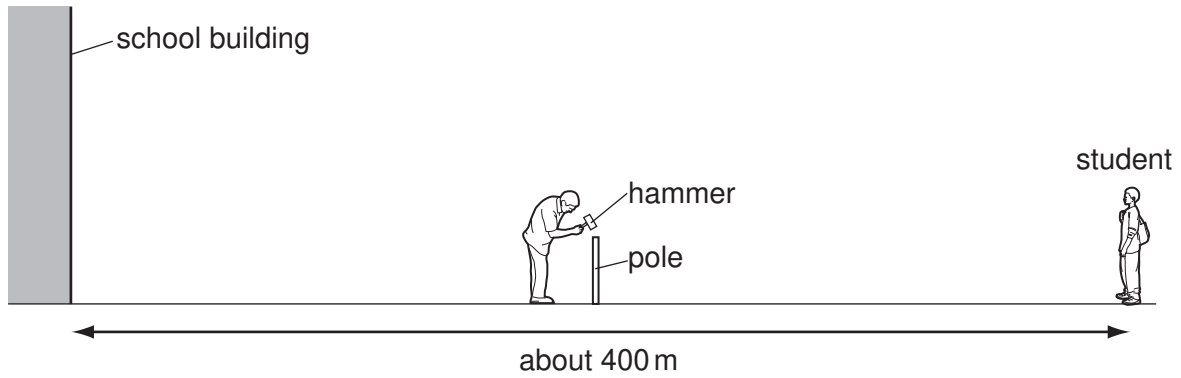

The student hears two bangs each time the hammer hits the pole.

Why does the student hear two bangs?

	first bang caused by	second bang caused by
<b>A</b>	sound of hammer hitting pole	sound of pole hitting hammer
<b>B</b>	sound reaching left ear	sound reaching right ear
<b>C</b>	sound reaching student directly	sound due to echo from school building
<b>D</b>	sound reflected back from school building	sound reaching student directly

- 25 A student uses three small plotting compasses to investigate the magnetic field around a bar magnet.

Which diagram shows the directions in which the compass needles point?

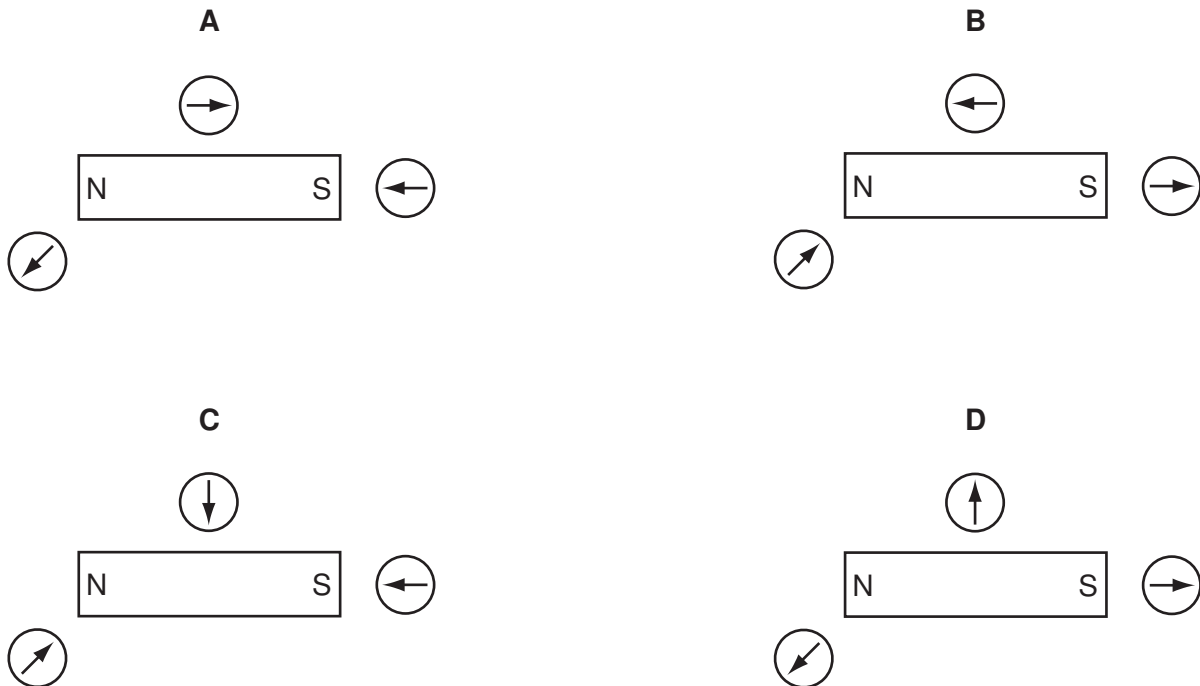

- 26 The ends of three metal rods are tested by holding end Q of rod 1 close to the others in turn.

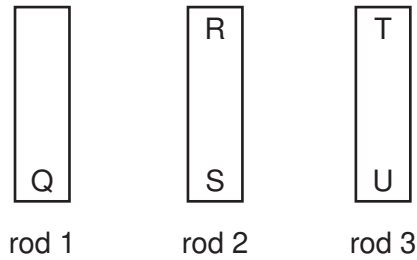

The results are as follows.

End Q: attracts end R,  
 attracts end S,  
 attracts end T,  
 repels end U.

Which of the metal rods is a magnet?

- A** rod 1 only
- B** rod 1 and rod 2 only
- C** rod 1 and rod 3 only
- D** rod 3 only
- 27 A student wishes to measure the electromotive force (e.m.f.) of a battery and the potential difference (p.d.) across a resistor.
- She has the resistor, the battery and some connecting wires.
- What else does she need?
- A** a voltmeter only
- B** an ammeter only
- C** an ammeter and a voltmeter
- D** a force meter (newton meter) and a voltmeter
- 28 Which particle does **not** experience a force due to an electric field?
- A**  $\alpha$ -particle
- B** electron
- C** neutron
- D** proton

- 29 A student uses a length of wire as a resistor. He discovers that the resistance of the wire is too small.

To be certain of making a resistor of higher value, he should use a piece of wire that is

- A longer and thicker.
- B longer and thinner.
- C shorter and thicker.
- D shorter and thinner.

- 30 Which graph shows how the resistance of a thermistor changes with temperature?

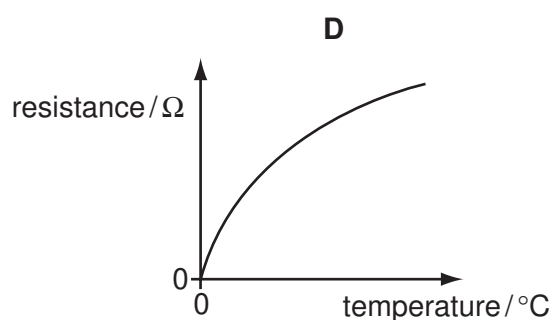
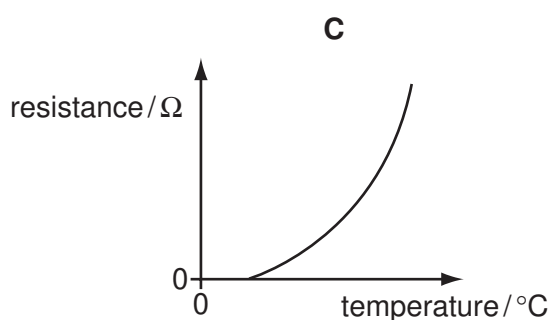
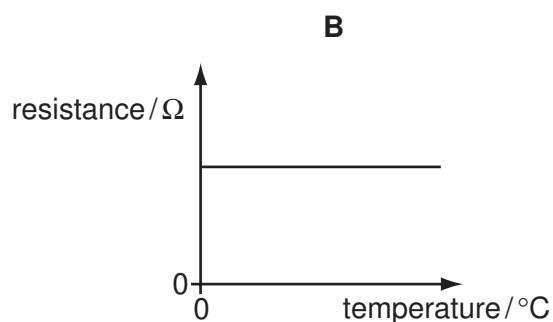
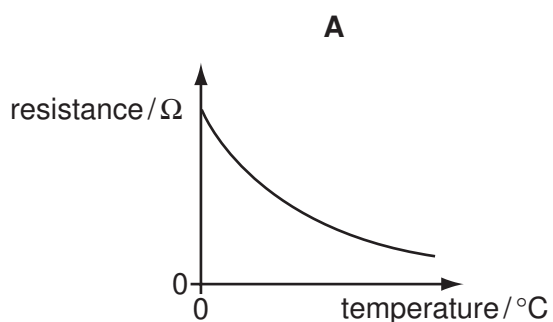

- 31 In the circuit below, one of the lamps breaks, causing all the other lamps to go out.

Which lamp breaks?

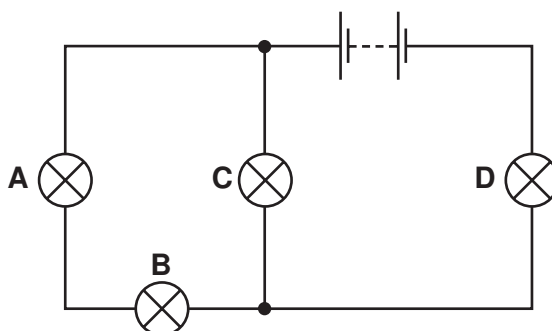

32 Circuit-breakers are used with electrical appliances as safety devices.

Which description is correct for a circuit-breaker?

	position	action when overloaded
<b>A</b>	connected in the live wire	melts
<b>B</b>	connected in the live wire	operates an electromagnet
<b>C</b>	connected to the casing of the appliance	melts
<b>D</b>	connected to the casing of the appliance	operates an electromagnet

33 An electric heater is connected to the mains using insulated copper wires. The wires become very warm.

What can be done to prevent so much heat being produced in the connecting wires?

- A** Use thicker copper wires.
- B** Use thinner copper wires.
- C** Use thicker insulation.
- D** Use thinner insulation.

34 The diagram shows an electrical device.

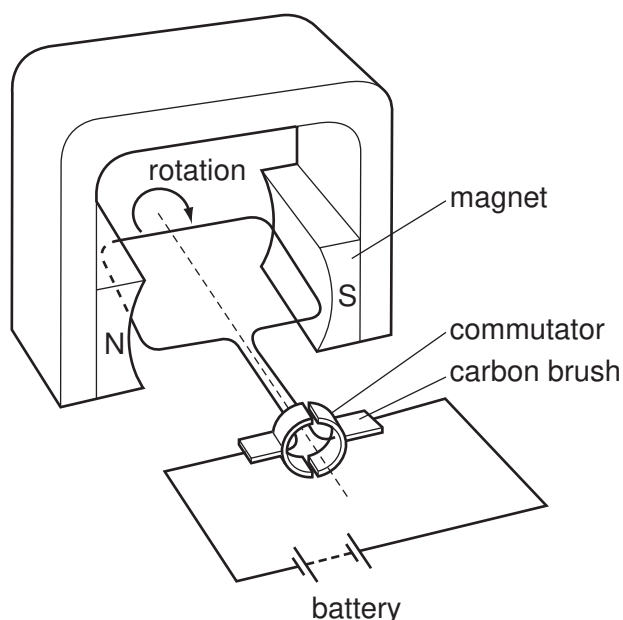

What is this electrical device?

- A** a d.c. motor
- B** an a.c. generator
- C** a magnetising coil
- D** a transformer



35 The graph shows the voltage input to a step-down transformer.

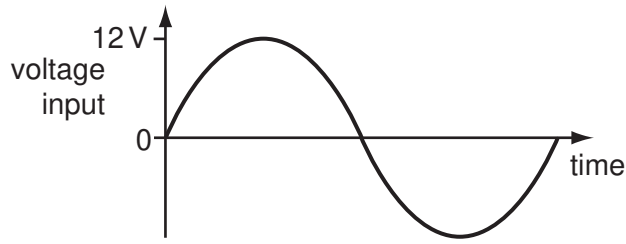

Which diagram shows the voltage output from the transformer?

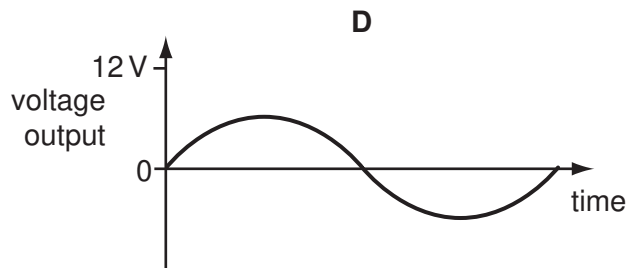
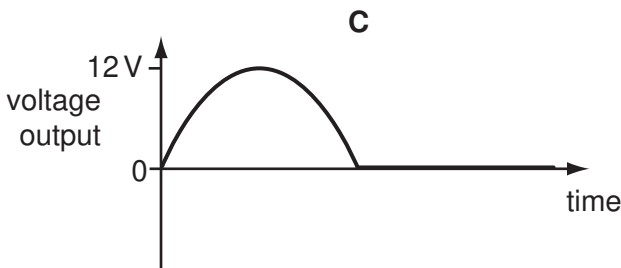
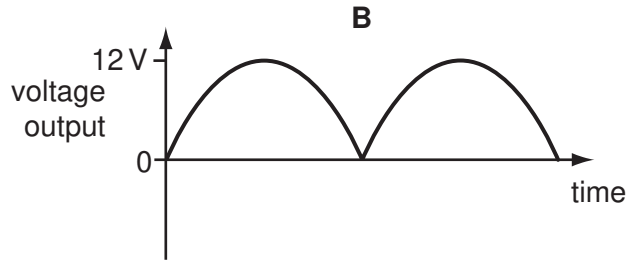
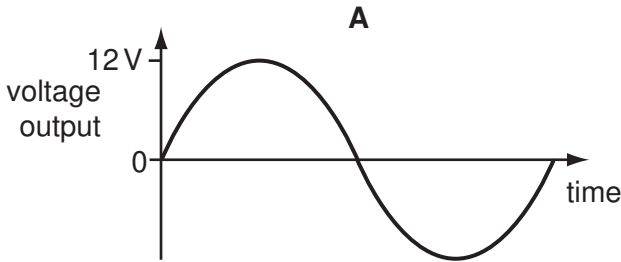

36 Particles are emitted by a heated cathode in a cathode-ray tube.

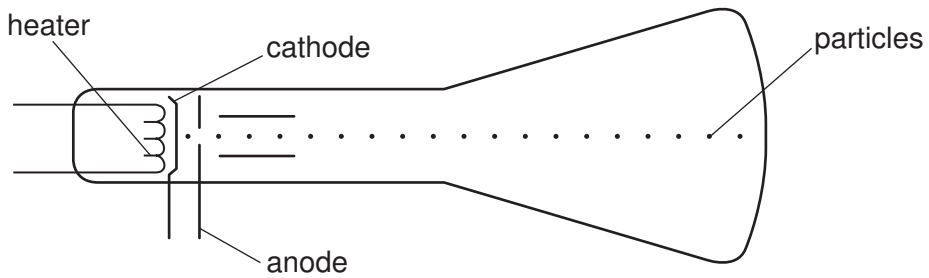

What are these particles?

- A** atoms
- B** electrons
- C** neutrons
- D** protons

37 Which line in the table describes the nature of an  $\alpha$ -particle and of a  $\gamma$ -ray?

	$\alpha$ -particle	$\gamma$ -ray
<b>A</b>	helium nucleus	electromagnetic radiation
<b>B</b>	helium nucleus	electron
<b>C</b>	proton	electromagnetic radiation
<b>D</b>	proton	electron

38 The count rates of four radioactive sources were measured at the same time on three consecutive days.

Which source has a half-life of two days?

	Monday	Tuesday	Wednesday
<b>A</b>	100	50	25
<b>B</b>	200	140	100
<b>C</b>	300	300	300
<b>D</b>	400	200	100

39 Which statement is true of all neutral atoms?

- A** The number of electrons equals the number of nucleons.
- B** The number of neutrons equals the number of protons.
- C** The number of nucleons equals the number of neutrons.
- D** The number of protons equals the number of electrons.

40 There are three nuclides of hydrogen.

nuclide 1	nuclide 2	nuclide 3
${}^1_1\text{H}$	${}^2_1\text{H}$	${}^3_1\text{H}$

Which of these nuclides have the same number of protons in their nuclei?

- A** 1 and 2 only
- B** 2 and 3 only
- C** all of them
- D** none of them

**BLANK PAGE**

**BLANK PAGE**

---

Permission to reproduce items where third-party owned material protected by copyright is included has been sought and cleared where possible. Every reasonable effort has been made by the publisher (UCLES) to trace copyright holders, but if any items requiring clearance have unwittingly been included, the publisher will be pleased to make amends at the earliest possible opportunity.

University of Cambridge International Examinations is part of the University of Cambridge Local Examinations Syndicate (UCLES), which is itself a department of the University of Cambridge.