



UNIVERSITY OF CAMBRIDGE INTERNATIONAL EXAMINATIONS
International General Certificate of Secondary Education

CANDIDATE
NAME

CENTRE
NUMBER

--	--	--	--	--

CANDIDATE
NUMBER

--	--	--	--



PHYSICS

0625/06

Paper 6 Alternative to Practical

May/June 2008

1 hour

Candidates answer on the Question Paper.
No Additional Materials are required.

READ THESE INSTRUCTIONS FIRST

Write your Centre number, candidate number and name on all work you hand in.
Write in dark blue or black pen.
You may use a soft pencil for any diagrams, graphs or rough working.
Do not use staples, paper clips, highlighters, glue or correction fluid.
DO NOT WRITE IN ANY BARCODES.

Answer **all** questions.

At the end of the examination, fasten all your work securely together.
The number of marks is given in brackets [] at the end of each question or part question.

For Examiner's Use	
1	
2	
3	
4	
5	
Total	

This document consists of **12** printed pages and **4** blank pages.



- 1 An IGCSE student is determining the density of a solid metal cylinder using a balancing method. Fig. 1.1. shows the apparatus.

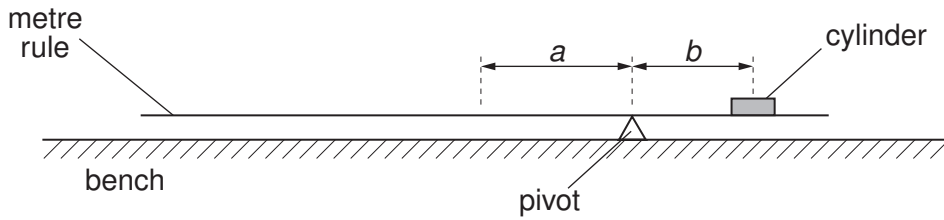

Fig. 1.1

He places the cylinder on the metre rule so that its centre is directly above the 10.0 cm mark. The rule is placed on the pivot so that the rule is as near as possible to being balanced.

He measures and records the distance a from the centre of the rule to the pivot and the distance b from the centre of the cylinder to the pivot. He repeats the experiment with the same cylinder at different positions on the rule.

The readings are shown in Table 1.1.

Table 1.1

$a/$	$b/$	$M/$
12.6	27.4	
11.0	24.0	
9.5	20.5	

- (a) (i) Complete the column headings in Table 1.1.
- (ii) For each set of readings, calculate the mass M of the cylinder using the equation

$$M = \frac{ka}{b}$$

The value of k is the mass of the rule which is 108 g.

Enter the results in Table 1.1.

[3]

- (b) The cylinder completely covers the marks on the metre rule. Describe, with the aid of a diagram, how you would judge that the centre of the cylinder is directly above the 10.0cm mark.

For
Examiner's
Use

.....
..... [1]

- (c) Use your answers in Table 1.1 to calculate and record the average of the three values for M . Show your working.

average value for M = [2]

(d) Fig. 1.2 shows the cylinder placed flat on the bench and viewed from one side.

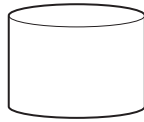

Fig. 1.2

(i) On the diagram, measure the diameter d and the thickness t of the cylinder.

$d = \dots\dots\dots$

$t = \dots\dots\dots$

(ii) Calculate the volume V of the cylinder using the equation

$$V = \frac{\pi d^2 t}{4}.$$

$V = \dots\dots\dots$

(iii) Calculate the density ρ of the cylinder using the equation

$$\rho = \frac{M}{V}.$$

$\rho = \dots\dots\dots$ [3]

[Total: 9]

BLANK PAGE

- 2 The IGCSE class is comparing the combined resistance of resistors in different circuit arrangements. The first circuit is shown in Fig. 2.1.

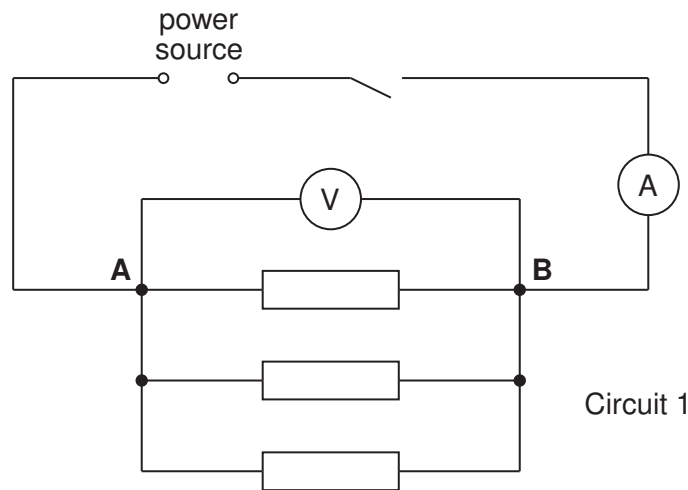

Fig. 2.1

- (a) The current I in the circuit and the p.d. V across the three resistors are measured and recorded. Three more circuit arrangements are used. For each arrangement, a student disconnects the resistors and then reconnects them between points **A** and **B** as shown in Figs. 2.2–2.4.

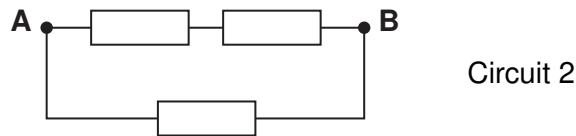

Fig. 2.2

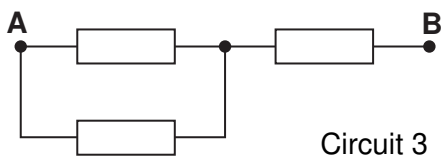

Fig. 2.3

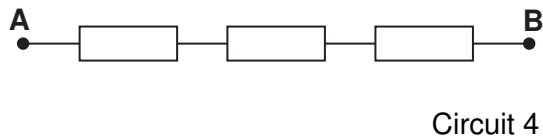

Fig. 2.4

The voltage and current readings are shown in the Table 2.1.

Table 2.1

Circuit	$V/$	$I/$	$R/$
1	1.87	1.68	
2	1.84	0.84	
3	1.87	0.37	
4	1.91	0.20	

- (i) Complete the column headings for each of the V , I and R columns of Table 2.1.

- (ii) For each circuit, calculate the combined resistance R of the three resistors using the equation

$$R = \frac{V}{I}.$$

For
Examiner's
Use

Record these values of R in Table 2.1. [3]

- (b) Theory suggests that, if all three resistors have the same resistance under all conditions, the combined resistance in circuit 1 will be one half of the combined resistance in circuit 2.

- (i) State whether, within the limits of experimental accuracy, your results support this theory. Justify your answer by reference to the results.

statement

justification

.....

- (ii) Suggest one precaution you could take to ensure that the readings are as accurate as possible.

.....

..... [3]

[Total: 6]

- 3 A student is investigating the effect of surface area exposed to the air on the rate of cooling of hot water.

For
Examiner's
Use

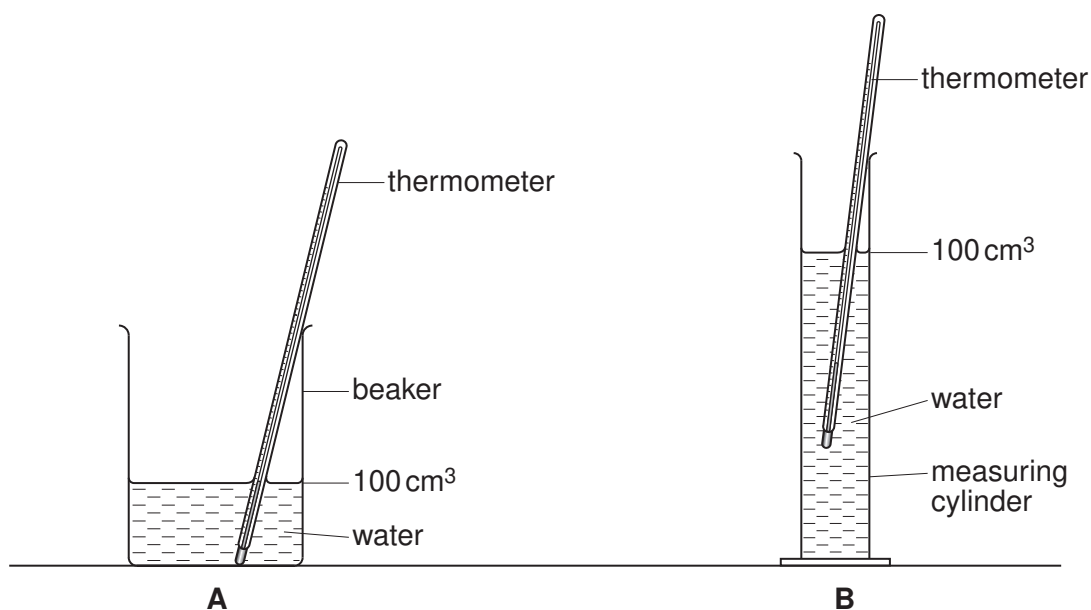

Fig. 3.1

The student is provided with two containers. The beaker is labelled **A** and the measuring cylinder is labelled **B**. Each container contains 100 cm³ of hot water. He records the temperature of the water at 30 s intervals for a total of four minutes. Table 3.1 shows the readings of time t and temperature θ .

Table 3.1

	container A (beaker)	container B (measuring cylinder)
t/s	$\theta/^\circ\text{C}$	$\theta/^\circ\text{C}$
0	85	85
30	76	79
60	68	74
90	63	69
120	59	66
150	56	63
180	54	61
210	52	59
240	51	58

- (a) (i) Use the data in Table 3.1 to plot a graph of $\theta/^\circ\text{C}$ (y -axis) against t/s (x -axis) **for the beaker**. Draw the best-fit curve.
- (ii) Use the data for the measuring cylinder to plot another curve on the same graph axes that you used for part (a)(i).

For
Examiner's
Use

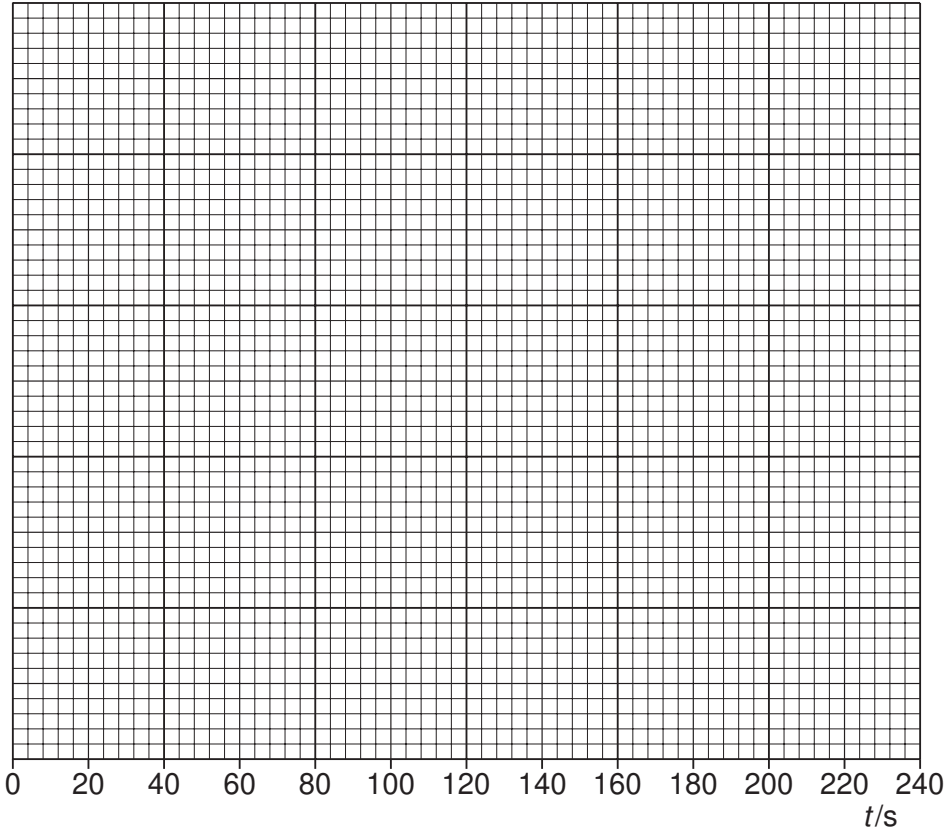

[6]

- (b) The experiment is designed to investigate the effect of the surface area exposed to the air on the rate of cooling. State briefly the effect of a larger surface area on the rate of cooling. Justify your answer by reference to your graph.

statement.....

justification.....

.....[2]

[Total: 8]

- 4 A student is determining a quantity called the refractive index of the material of a transparent block.

Fig. 4.1 shows the ray-tracing sheet that the student is producing. **ABCD** is the outline of the transparent block, drawn on the ray-tracing sheet.

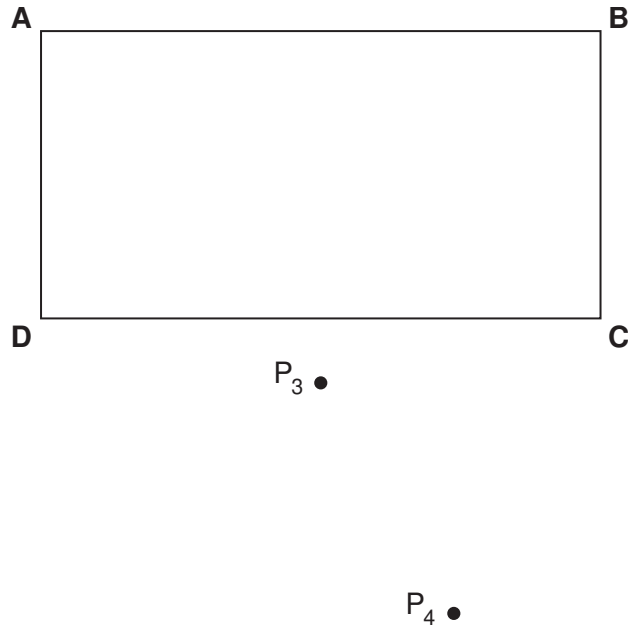

Fig. 4.1

- (a) (i) Draw the normal **NN'** to side **AB**, extended to cross side **DC**, so that the normal is 2.0 cm from **A**. Label the point **F** where **NN'** crosses **AB**. Label the point **G** where **NN'** crosses **DC**.
- (ii) Draw the line **EF** at an angle of 30° to the normal and to the left of the normal **NN'**. **E** is a point outside the block and above **AB** on the ray-tracing sheet.

[3]

- (b) Read the following passage, taken from the student's notebook and then answer the questions that follow.

For
Examiner's
Use

I placed two pins P_1 and P_2 on line **EF**.
I observed the images of P_1 and P_2 through side **CD** of the block so that the images of P_1 and P_2 appeared one behind the other. I placed two more pins P_3 and P_4 between my eye and the block so that P_3 , P_4 and the images of P_1 and P_2 , seen through the block, appeared one behind the other. I marked the positions of P_1 , P_2 , P_3 and P_4 .

- (i) Draw a line joining the positions of P_3 and P_4 . Continue the line until it meets **CD**. Label this point **H**.

- (ii) Measure and record the length a of the line **GH**.

$a = \dots\dots\dots$

- (iii) Draw the line **HF**.

- (iv) Measure and record the length b of the line **HF**.

$b = \dots\dots\dots$ [3]

- (c) Extend the straight line **EF** through the outline of the block to a point **J**. The point **J** must be at least 5 cm from the block. The line **EJ** crosses the line **CD**. Label this point **K**.

- (i) Measure and record the length c of the line **GK**.

$c = \dots\dots\dots$

- (ii) Measure and record the length d of the line **FK**.

$d = \dots\dots\dots$

- (iii) Calculate the refractive index n of the material of the block using the equation

$$n = \frac{cb}{ad}$$

$n = \dots\dots\dots$ [3]

[Total: 9]

- 5 An IGCSE student has carried out a timing experiment using a simple pendulum. She plotted a graph of T^2/s^2 against l/m . T is the time for one swing of the pendulum and l is the length of the pendulum. The graph is shown below.

For
Examiner's
Use

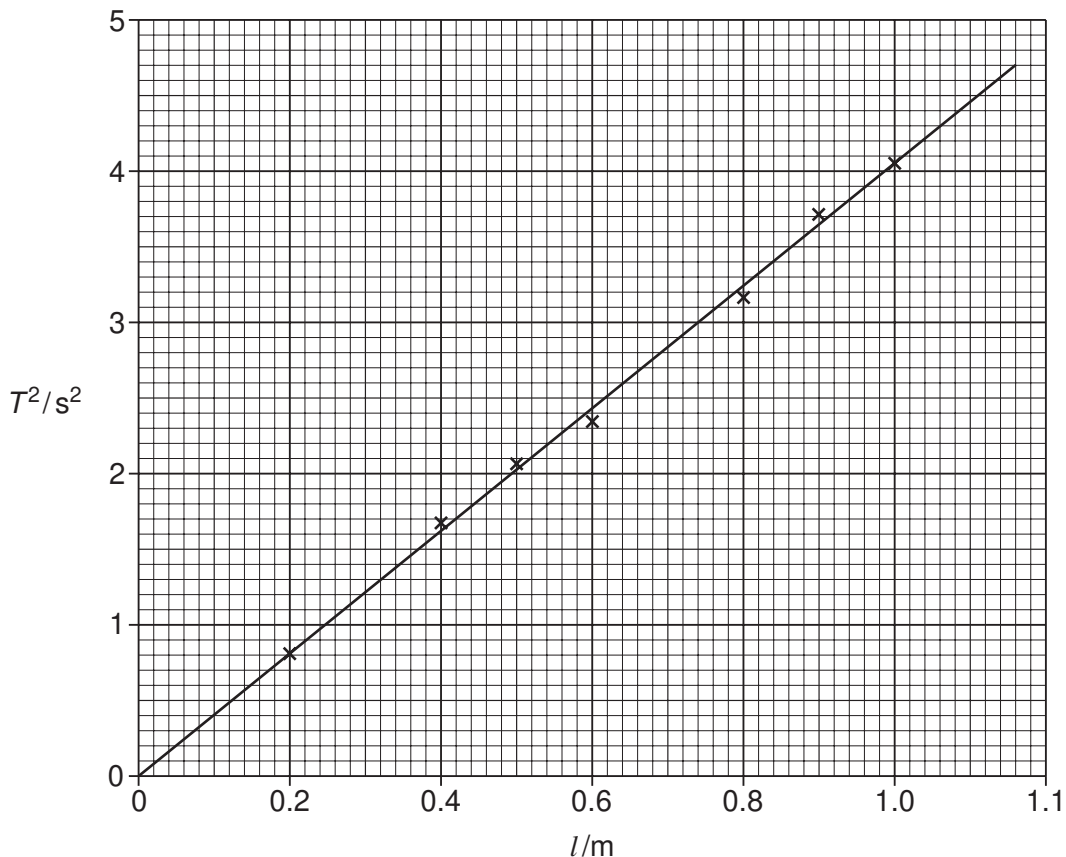

- (a) (i) Determine the gradient G of the graph. Show clearly on the graph how you obtained the necessary information.

$G = \dots\dots\dots$

- (ii) Calculate the acceleration g of free fall using the equation

$$g = \frac{4\pi^2}{G}$$

$g = \dots\dots\dots m/s^2$

- (iii) The student could have calculated the acceleration of free fall g from just one set of readings. State the purpose of taking sufficient readings to plot a graph.

.....

..... [5]

- (b) The student next studies the relationship between the mass m of the pendulum and the time for one swing T . The readings are shown in Table 5.1.

For
Examiner's
Use

Table 5.1

m/g	T/s
50	1.58
100	1.60
150	1.61
200	1.57
250	1.59

- (i) Suggest two variables that must be kept constant to make the experiment a fair test.

1.

2.

- (ii) Study the readings in the table and complete the following sentence.

Within the limits of experimental accuracy, the readings show that the mass m of the pendulum [3]

[Total: 8]

BLANK PAGE

Permission to reproduce items where third-party owned material protected by copyright is included has been sought and cleared where possible. Every reasonable effort has been made by the publisher (UCLES) to trace copyright holders, but if any items requiring clearance have unwittingly been included, the publisher will be pleased to make amends at the earliest possible opportunity.

University of Cambridge International Examinations is part of the Cambridge Assessment Group. Cambridge Assessment is the brand name of University of Cambridge Local Examinations Syndicate (UCLES), which is itself a department of the University of Cambridge.