



UNIVERSITY OF CAMBRIDGE INTERNATIONAL EXAMINATIONS
International General Certificate of Secondary Education

CANDIDATE
NAME

CENTRE
NUMBER

--	--	--	--	--

CANDIDATE
NUMBER

--	--	--	--

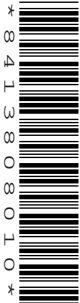

PHYSICS

0625/06

Paper 6 Alternative to Practical

October/November 2009

1 hour

Candidates answer on the Question Paper.
No Additional Materials are required.

READ THESE INSTRUCTIONS FIRST

Write your Centre number, candidate number and name on all the work you hand in.
Write in dark blue or black pen.
You may use a soft pencil for any diagrams, graphs or rough working.
Do not use staples, paper clips, highlighters, glue or correction fluid.
DO NOT WRITE IN ANY BARCODES.

Answer **all** questions.

At the end of the examination, fasten all your work securely together.
The number of marks is given in brackets [] at the end of each question or part question.

For Examiner's Use	
1	
2	
3	
4	
5	
Total	

This document consists of **14** printed pages and **2** blank pages.



- 1 The IGCSE class is investigating the period of oscillation of a simple pendulum.

Fig. 1.1 shows the set-up.

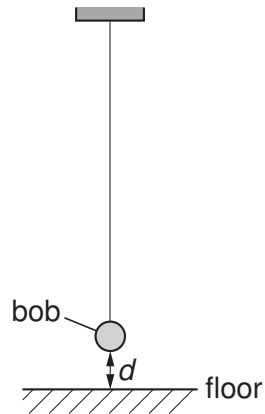

Fig. 1.1

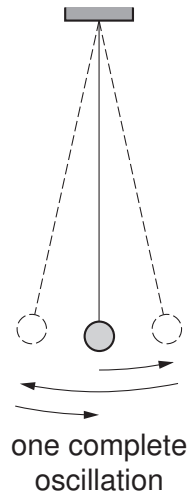

Fig. 1.2

- (a) (i) On Fig. 1.1, measure the vertical distance d from the floor to the bottom of the pendulum bob.

$d = \dots\dots\dots$

- (ii) Fig. 1.1 is drawn one twentieth actual size. Calculate the actual distance x from the floor to the bottom of the pendulum bob. Enter this value in the top row of Table 1.1.

The students displace the pendulum bob slightly and release it so that it swings. They measure and record in Table 1.1 the time t for 20 complete oscillations of the pendulum (see Fig. 1.2).

Table 1.1

x/cm	t/s	T/s	T^2/s^2
	20.0		
20.0	19.0		
30.0	17.9		
40.0	16.8		
50.0	15.5		

[4]

- (b) (i) Calculate the period T of the pendulum for each set of readings. The period is the time for one complete oscillation. Enter the values in Table 1.1.

For
Examiner's
Use

- (ii) Calculate the values of T^2 . Enter the T^2 values in Table 1.1.

- (c) Use your values from Table 1.1 to plot a graph of T^2/s^2 (y -axis) against x/cm (x -axis). Draw the best-fit line.

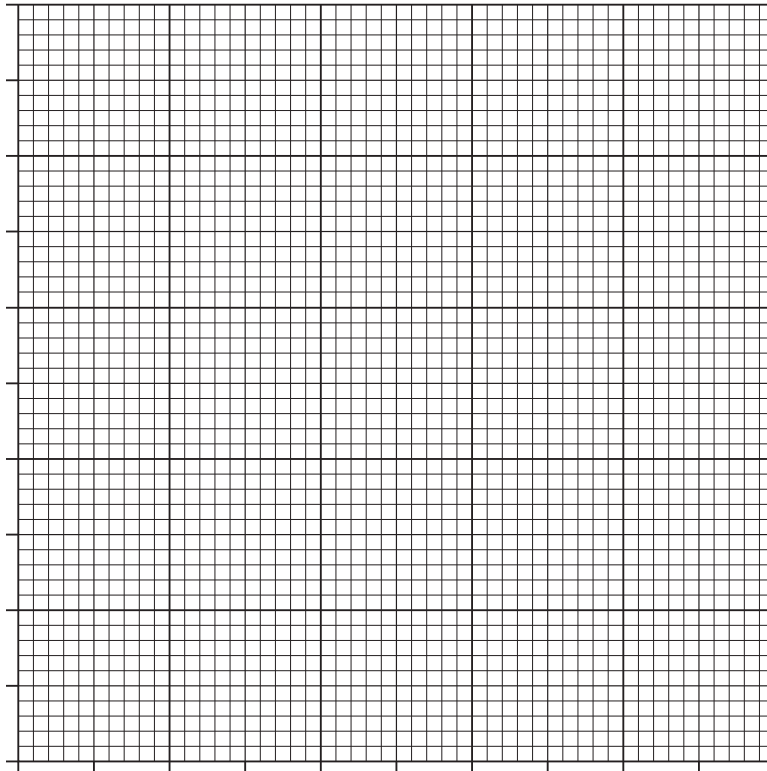

[5]

(d) State whether or not your graph shows that T^2 is directly proportional to x . Justify your statement by reference to the graph.

*For
Examiner's
Use*

statement

justification

..... [1]

[Total: 10]

BLANK PAGE

- 2 An IGCSE student is investigating the cooling of thermometer bulbs under different conditions.

He places a thermometer in a beaker of hot water and records the temperature θ_h of the hot water.

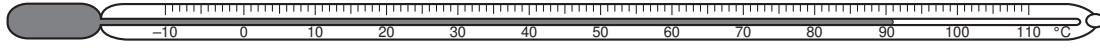

Fig. 2.1

- (a) Fig. 2.1 shows the thermometer. Write down the value of θ_h that it shows.

θ_h [1]

He then moves the thermometer until the thermometer bulb is just above the surface of the water (position **A**) and immediately starts a stopclock.

He records the time t and the temperature reading θ every 30 s. The readings are shown in Table 2.1.

Table 2.1

	Position A	Position B
$t/$	$\theta/$	$\theta/$
30	65	56
60	58	47
90	54	40
120	52	35
150	50	32
180	48	30

- (b) Complete the column headings in the table.

[1]

The student replaces the thermometer in the hot water and then moves the thermometer 15 cm away from the beaker to position **B** and immediately starts the stopclock. He records the time t and the temperature reading θ every 30 s. The readings are shown in Table 2.1.

*For
Examiner's
Use*

- (c) State in which position the thermometer bulb cooled more quickly. Justify your answer by reference to the readings.

statement

justification

..... [1]

- (d) To make a fair comparison between the rates of cooling of the thermometer bulbs in the two positions, it is important to control other experimental conditions. Suggest two conditions that should be controlled in this experiment.

1.

2. [2]

[Total: 5]

- 3 The IGCSE class is comparing the combined resistance of lamps arranged either in series or in parallel.

For
Examiner's
Use

The circuit shown in Fig. 3.1 is used.

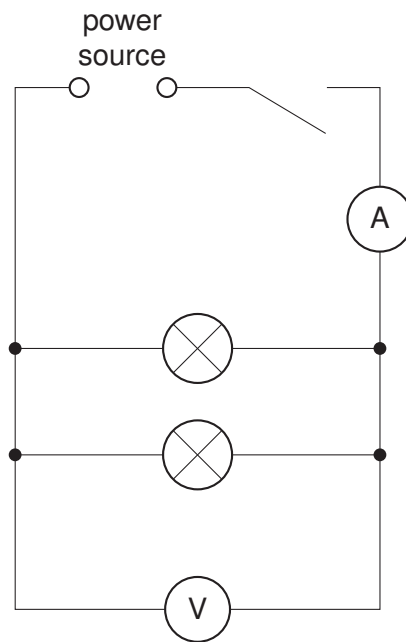

Fig. 3.1

A student measures and records the current I in the circuit and the p.d. V across the two lamps.

Fig. 3.2 shows the readings on the two meters.

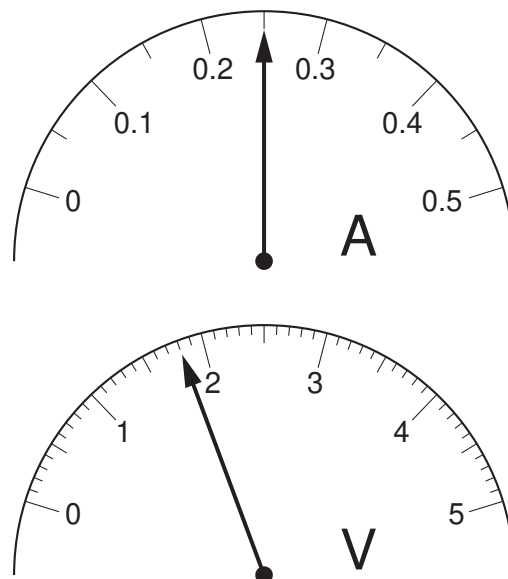

Fig. 3.2

- (a) (i) Write the voltage and current readings in Table 3.1, below.
 (ii) Complete the column headings in Table 3.1.

[3]

- (b) The student then sets up the circuit shown in Fig. 3.3 and records the readings. These readings have already been entered in Table 3.1.

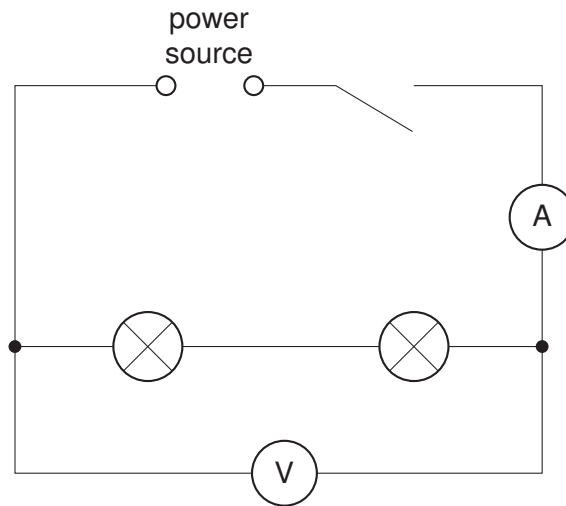

Fig. 3.3

For each set of readings in the table, calculate the combined resistance R of the two lamps using the equation $R = V/I$. Record the values of R in Table 3.1. [2]

Table 3.1

	$V/$	$I/$	$R/$
Circuit of Fig. 3.1			
Circuit of Fig. 3.3	1.8	0.52	

- (c) Using the values of resistance you have obtained, calculate the ratio y of the resistances using the equation

$$y = \frac{\text{resistance of lamps in series}}{\text{resistance of lamps in parallel}}$$

$y = \dots\dots\dots$

[2]

(d) Fig. 3.4 shows a circuit including two motors **A** and **B**.

For
Examiner's
Use

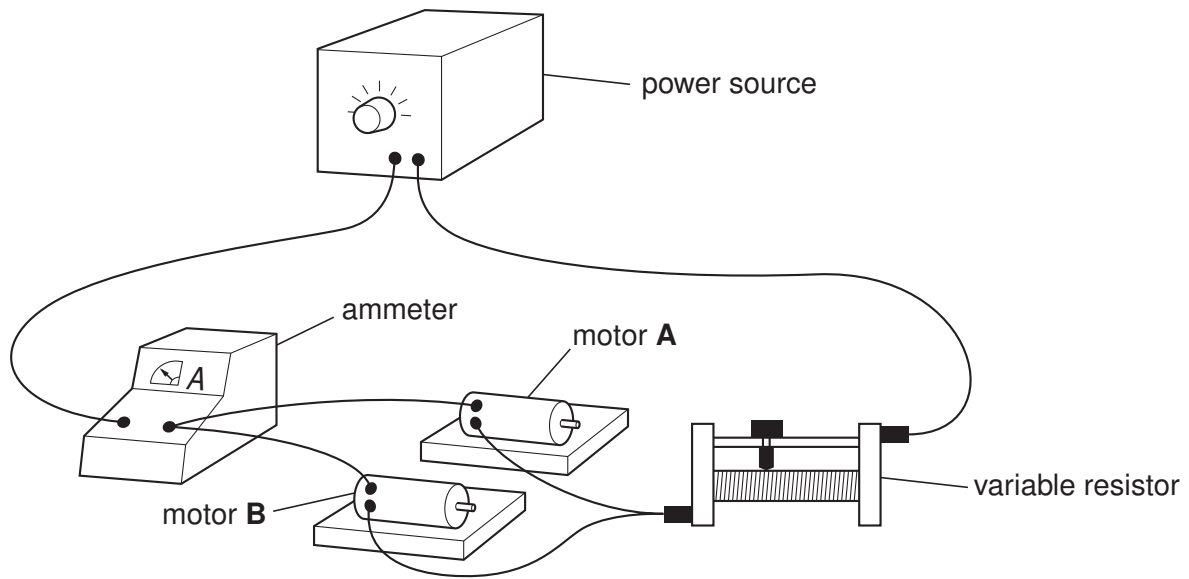
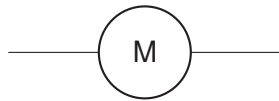

Fig. 3.4

- (i) Draw a diagram of the circuit using standard circuit symbols. The circuit symbol for a motor is:



(ii) An engineer wishes to measure the voltage across motor **A**.

*For
Examiner's
Use*

1. On Fig. 3.4, mark with the letters **X** and **Y** where the engineer should connect the voltmeter.
2. State the purpose of the variable resistor.

.....
.....

[3]

[Total: 10]

4 An IGCSE student is determining the focal length of a lens by two different methods.

The set-up for Method 1 is shown in Fig. 4.1.

For
Examiner's
Use

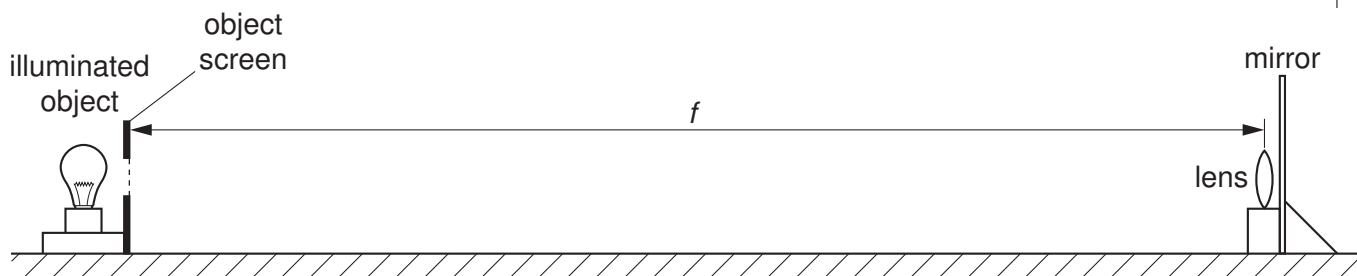

Fig. 4.1

The student moves the lens and the mirror slowly towards the object screen until a sharply focused image is obtained on the object screen as shown in Fig. 4.2.

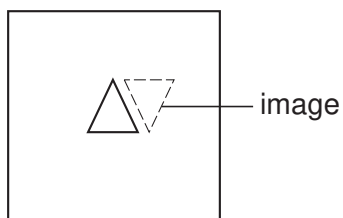

Fig. 4.2

(a) On Fig. 4.1, use your rule to measure the distance f between the lens and the object screen. This is the focal length of the lens.

$f = \dots\dots\dots$ [2]

(b) For Method 2, the student takes measurements of the diameter d and maximum thickness t of the lens. Use your rule to take measurements on Fig. 4.3.

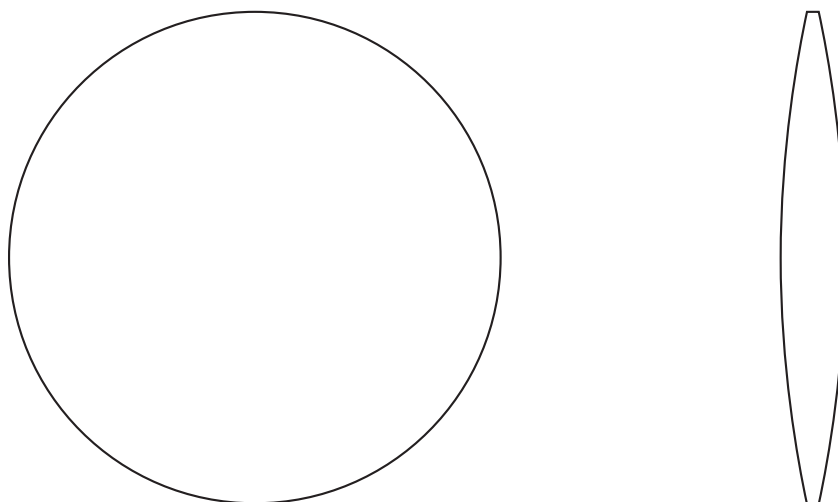

Fig. 4.3

- (i) Determine an average value for the diameter d of the lens. Record your readings in the space below.

For
Examiner's
Use

$d = \dots\dots\dots$

- (ii) Measure the maximum thickness t of the lens.

$t = \dots\dots\dots$

- (iii) Draw a diagram to show how, in the laboratory you would use two rectangular blocks of wood and a metre rule to measure the thickness of the lens as accurately as possible.

- (iv) Theory shows that, for a perfectly formed lens, the focal length is given by the formula

$$f = \frac{d^2}{kt} \quad \text{where } k = 4.16.$$

Calculate the focal length f of the lens using this formula.

$f = \dots\dots\dots$

[7]

(c) Explain whether your results from Methods 1 and 2 support the theory in part (b)(iv).

*For
Examiner's
Use*

.....

.....

..... [1]

[Total: 10]

5 An IGCSE student is carrying out an optics experiment.

The experiment involves using a lens to focus the image of an illuminated object onto a screen.

(a) Complete the diagram below to show the apparatus you would use. Include a metre rule to measure the distances between the object and the lens and between the lens and the screen. The illuminated object is drawn for you.

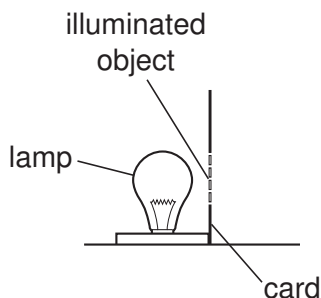

[3]

(b) State two precautions that you would take to obtain accurate results in this experiment.

- 1.
-
- 2.
-

[2]

[Total: 5]

BLANK PAGE

Permission to reproduce items where third-party owned material protected by copyright is included has been sought and cleared where possible. Every reasonable effort has been made by the publisher (UCLES) to trace copyright holders, but if any items requiring clearance have unwittingly been included, the publisher will be pleased to make amends at the earliest possible opportunity.

University of Cambridge International Examinations is part of the Cambridge Assessment Group. Cambridge Assessment is the brand name of University of Cambridge Local Examinations Syndicate (UCLES), which is itself a department of the University of Cambridge.