



UNIVERSITY OF CAMBRIDGE INTERNATIONAL EXAMINATIONS
International General Certificate of Secondary Education

PHYSICS

0625/12

Paper 1 Multiple Choice

May/June 2010

45 minutes

Additional Materials: Multiple Choice Answer Sheet
Soft clean eraser
Soft pencil (type B or HB recommended)

* 3 7 7 8 1 2 0 5 5 2 *

READ THESE INSTRUCTIONS FIRST

Write in soft pencil.
Do not use staples, paper clips, highlighters, glue or correction fluid.
Write your name, Centre number and candidate number on the Answer Sheet in the spaces provided unless this has been done for you.

There are **forty** questions on this paper. Answer **all** questions. For each question there are four possible answers **A, B, C** and **D**.
Choose the **one** you consider correct and record your choice in **soft pencil** on the separate Answer Sheet.

Read the instructions on the Answer Sheet very carefully.

Each correct answer will score one mark. A mark will not be deducted for a wrong answer.
Any rough working should be done in this booklet.

This document consists of **18** printed pages and **2** blank pages.



- 1 A student uses a stopwatch to time a runner running around a circular track. The runner runs two laps (twice around the track). The diagrams show the reading on the stopwatch when the runner starts running, at the end of the first lap, and at the end of the second lap.



reading when
runner starts



reading at end
of first lap



reading at end
of second lap

What is the time taken for the runner to run the second lap?

- A** 0 min 50 s **B** 1 min 10 s **C** 1 min 13 s **D** 2 min 03 s
- 2 A snail moves along a ruler. It takes 20 s to move from Q to R.

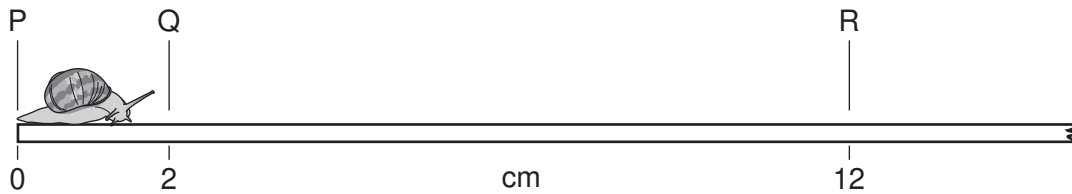

What is its average speed from Q to R?

- A** $\frac{12}{20}$ cm/s
- B** $\frac{12-2}{20}$ cm/s
- C** $\frac{20}{12}$ cm/s
- D** $\frac{20}{12-2}$ cm/s

- 3 A scientist needs to determine the volume of a small, irregularly shaped rock sample. Only a rule and a measuring cylinder, partially filled with water, are available.

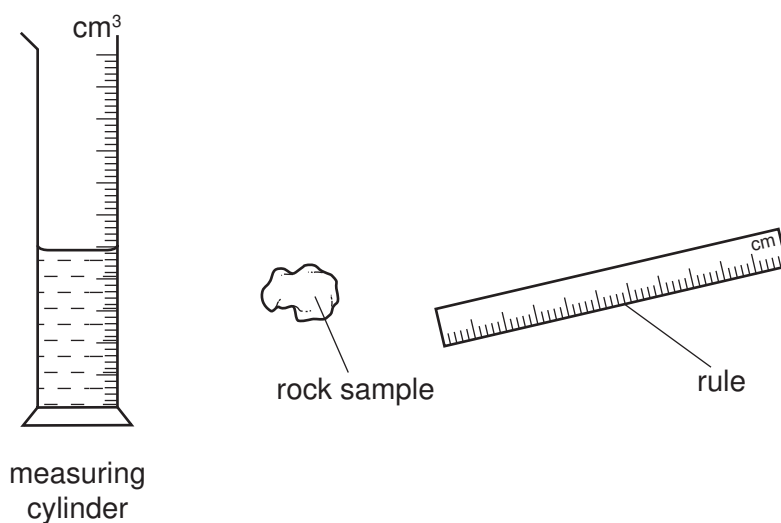

To determine the volume, which apparatus should the scientist use?

- A both the measuring cylinder and the rule
 - B neither the measuring cylinder nor the rule
 - C the measuring cylinder only
 - D the rule only
- 4 The diagram shows a rectangular block of density 2 g/cm^3 .

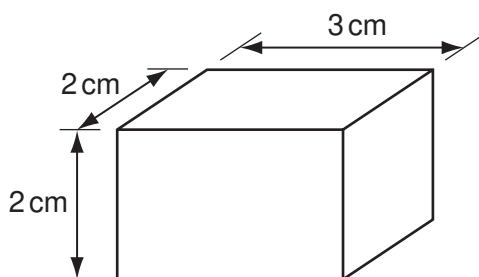

What is the mass of the block?

- A 2 g
- B 6 g
- C 14 g
- D 24 g

5 Two distance/time graphs and two speed/time graphs are shown.

Which graph represents an object that is at rest?

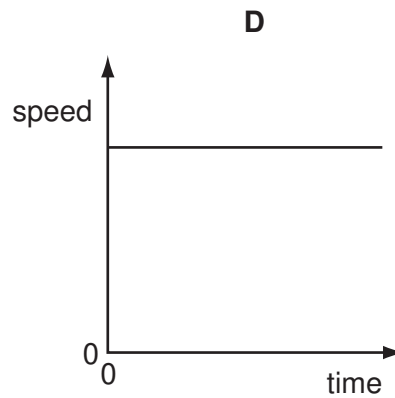
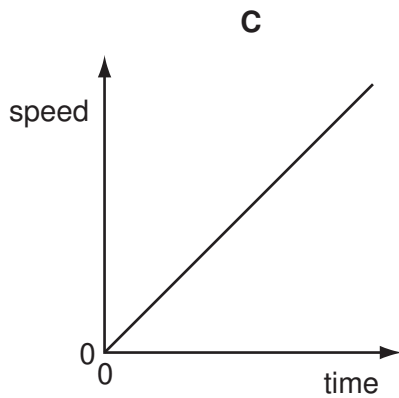
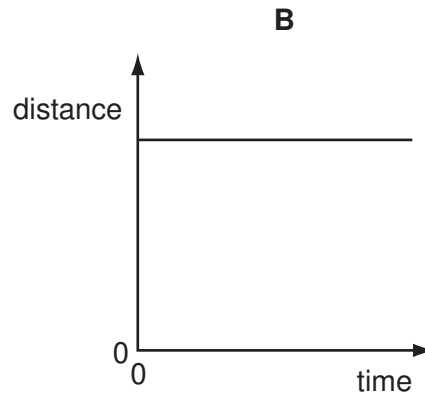
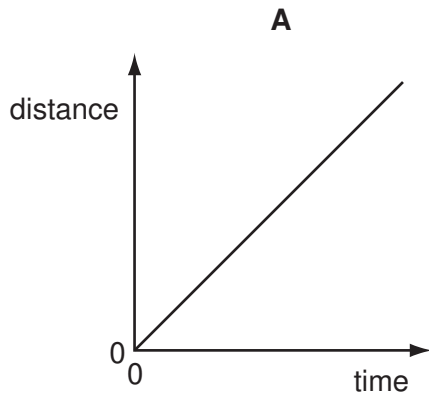

6 Which statement about a moving object is correct?

- A** When an object is accelerating, the resultant force acting on it must equal zero.
- B** When an object is moving at a steady speed, the air resistance acting on it must equal zero.
- C** When an object is moving at a steady speed, the resultant force acting on it must equal zero.
- D** When an object is moving, there must be a resultant force acting on it.

- 7 An experiment is carried out to measure the extension of a rubber band for different loads.

The results are shown below.

load/N	0	1	2	3
length/cm	15.2	16.2		18.6
extension/cm	0	1.0	2.1	3.4

Which figure is missing from the table?

- A 17.2 B 17.3 C 17.4 D 17.6
- 8 Two blocks of metal X and Y hang from spring balances as shown in the diagram.

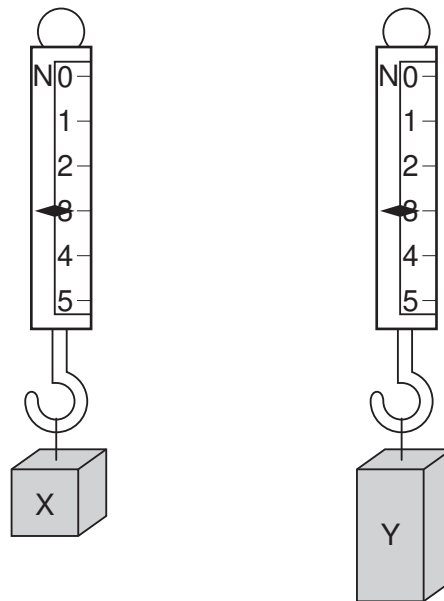

What does the diagram show about X and Y?

- A They have the same mass and the same volume but different weights.
 B They have the same mass and the same weight but different volumes.
 C They have the same mass, the same volume and the same weight.
 D They have the same weight and the same volume but different masses.

- 9 The graph shows how weight varies with mass on planet P and on planet Q.

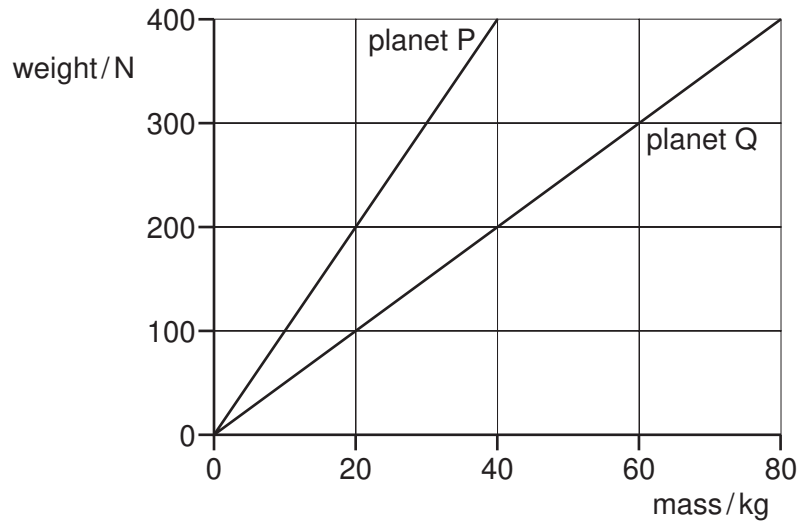

An object weighs 400 N on planet P. The object is taken to planet Q.

Which row is correct?

	mass of object on planet Q/kg	weight of object on planet Q/N
A	40	200
B	40	400
C	80	200
D	80	400

- 10 A man lifts 20 bricks, each of weight 6 N.

What other information is needed to calculate the useful work done in lifting the bricks?

- A** the distance he lifts the bricks
- B** the mass of the bricks
- C** the time taken to lift the bricks
- D** the volume of the bricks

- 11 To prevent a cement mixer sinking into soft ground, the mixer is placed on a large flat board.

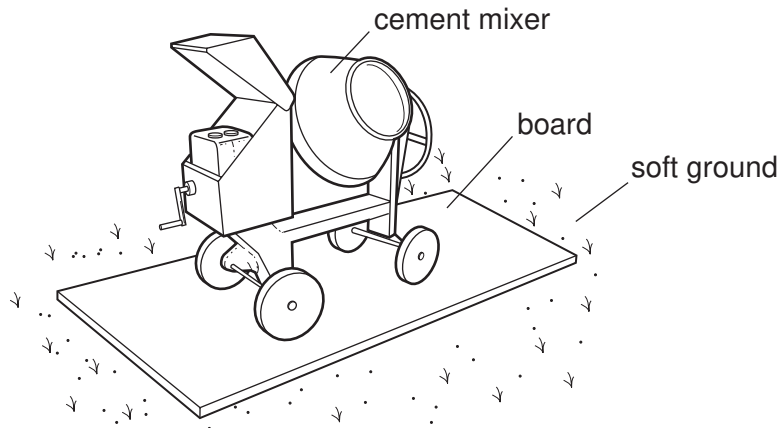

Why does this prevent the mixer sinking?

- A The large area decreases the pressure on the ground.
 - B The large area increases the pressure on the ground.
 - C The large area decreases the weight on the ground.
 - D The large area increases the weight on the ground.
- 12 The pressure of a gas is measured using a manometer as shown in the diagram.

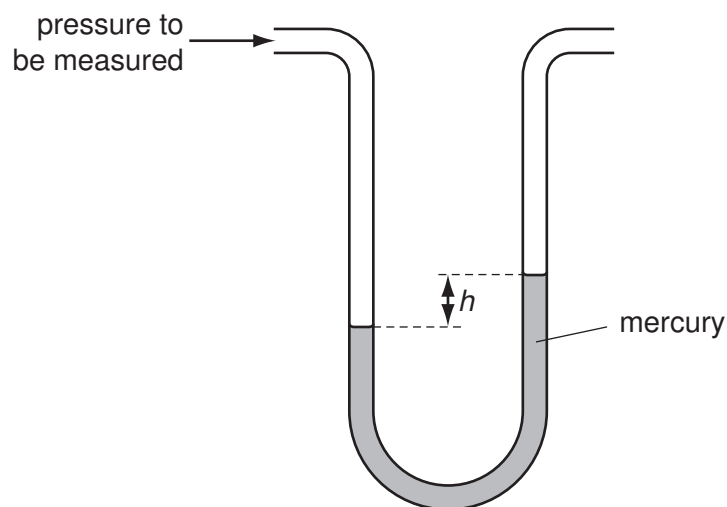

The mercury in the manometer is replaced with a liquid which is less dense.

How does the value of h change?

- A It becomes zero.
- B It decreases, but not to zero.
- C It stays the same.
- D It increases.

- 13 A thermometer has a scale which starts at -10°C and ends at 110°C .

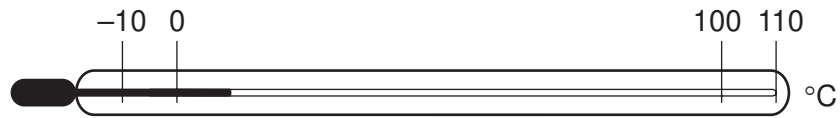

What is the value of the lower fixed point and of the upper fixed point of the scale?

	lower fixed point $/^{\circ}\text{C}$	upper fixed point $/^{\circ}\text{C}$
A	-10	100
B	-10	110
C	0	100
D	0	110

- 14 Energy is stored in a battery and in a box of matches.

Which type of energy is stored in each of them?

	a battery	a box of matches
A	chemical	chemical
B	chemical	internal (thermal)
C	electrical	chemical
D	electrical	internal (thermal)

- 15 Hot liquid in a vacuum flask cools extremely slowly. This is because some methods of heat transfer cannot take place in a vacuum.

Which methods **cannot** take place in a vacuum?

- A** conduction and convection only
- B** conduction and radiation only
- C** convection and radiation only
- D** conduction, convection and radiation

- 16 A teacher demonstrates convection currents using a box with two chimneys and a lighted candle. She holds a smoking taper at point P.

In which direction does the convection current cause the smoke to move?

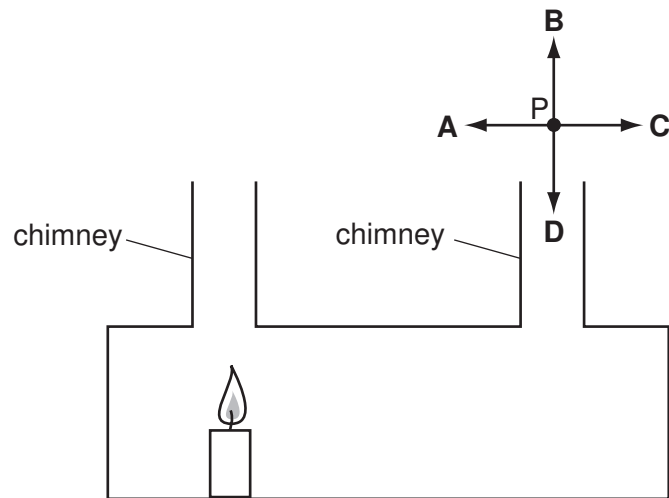

- 17 The diagram represents the molecules of a gas in a closed container of constant volume.

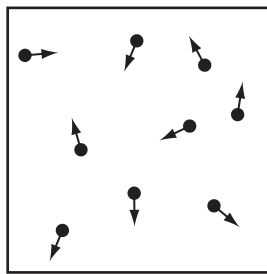

What happens to the molecules when the gas is heated?

- A They expand.
- B They hit the walls less often.
- C They move further apart.
- D They move more quickly.

18 A liquid is left in an open dish. After several days there is less liquid in the dish.

Which statement explains this?

- A The least energetic molecules leave the surface and escape into the air.
- B The least energetic molecules leave the surface and return.
- C The most energetic molecules leave the surface and escape into the air.
- D The most energetic molecules leave the surface and return.

19 A student carries out an experiment to find the melting point of wax. The graph shows how the temperature of the wax changes as it cools.

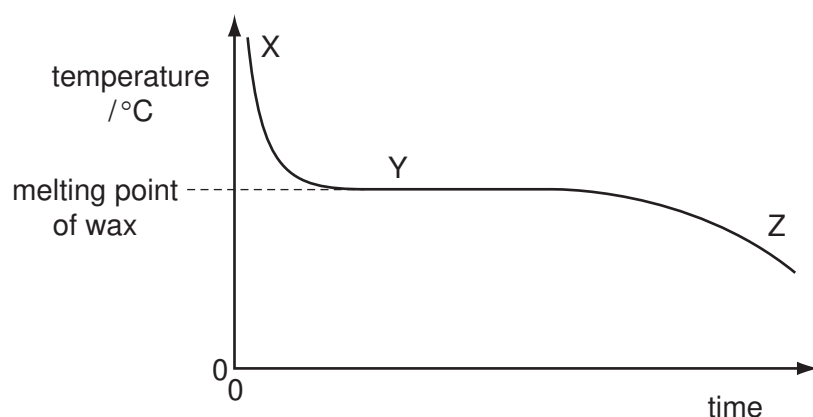

Which statement is correct?

- A At X the temperature drops more slowly than at Z.
- B At Y all the wax is solid.
- C At Y thermal energy is being given out by the wax.
- D At Z the wax molecules are not moving.

20 Which waves are longitudinal?

A

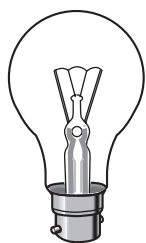

light waves
from a lamp

B

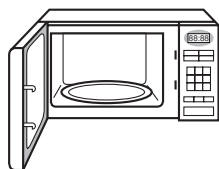

microwaves
in an oven

C



sound waves
from a trumpet

D

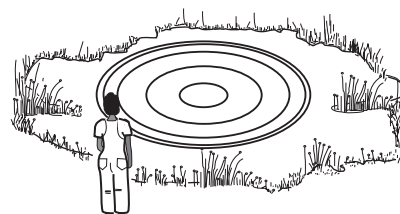

water waves
on a pond

- 21 A police car siren emits two different sounds P and Q. These are produced alternately. The diagram represents the sounds emitted.

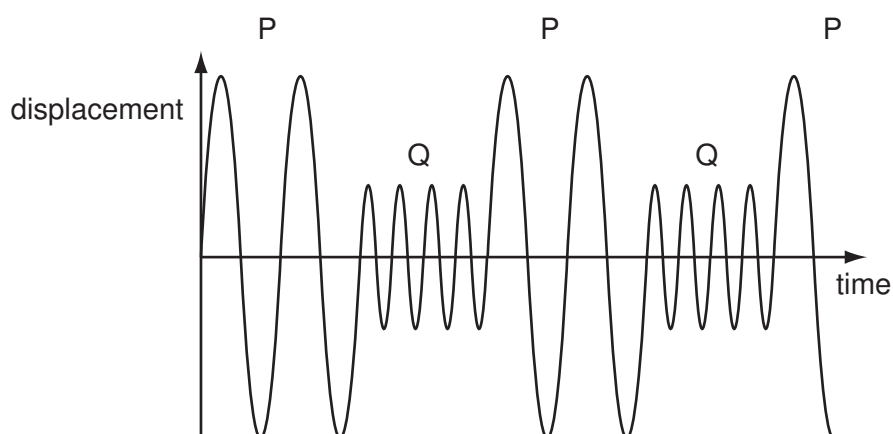

Which sound is the louder and which has the lower pitch?

	louder	lower pitch
A	P	P
B	P	Q
C	Q	P
D	Q	Q

- 22 What is the approximate value of the highest frequency that can be heard by a young person?

A 20 Hz **B** 200 Hz **C** 2000 Hz **D** 20 000 Hz

- 23 A navigation buoy floating on the sea oscillates up and down as a wave passes.

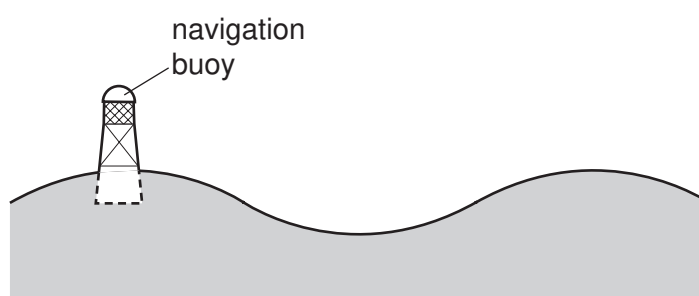

In exactly two minutes, six complete wavelengths pass the buoy.

What is the frequency of the waves?

A 0.050 Hz **B** 0.33 Hz **C** 3.0 Hz **D** 20 Hz

24 Which diagram correctly shows rays of light passing through a converging lens in a camera?

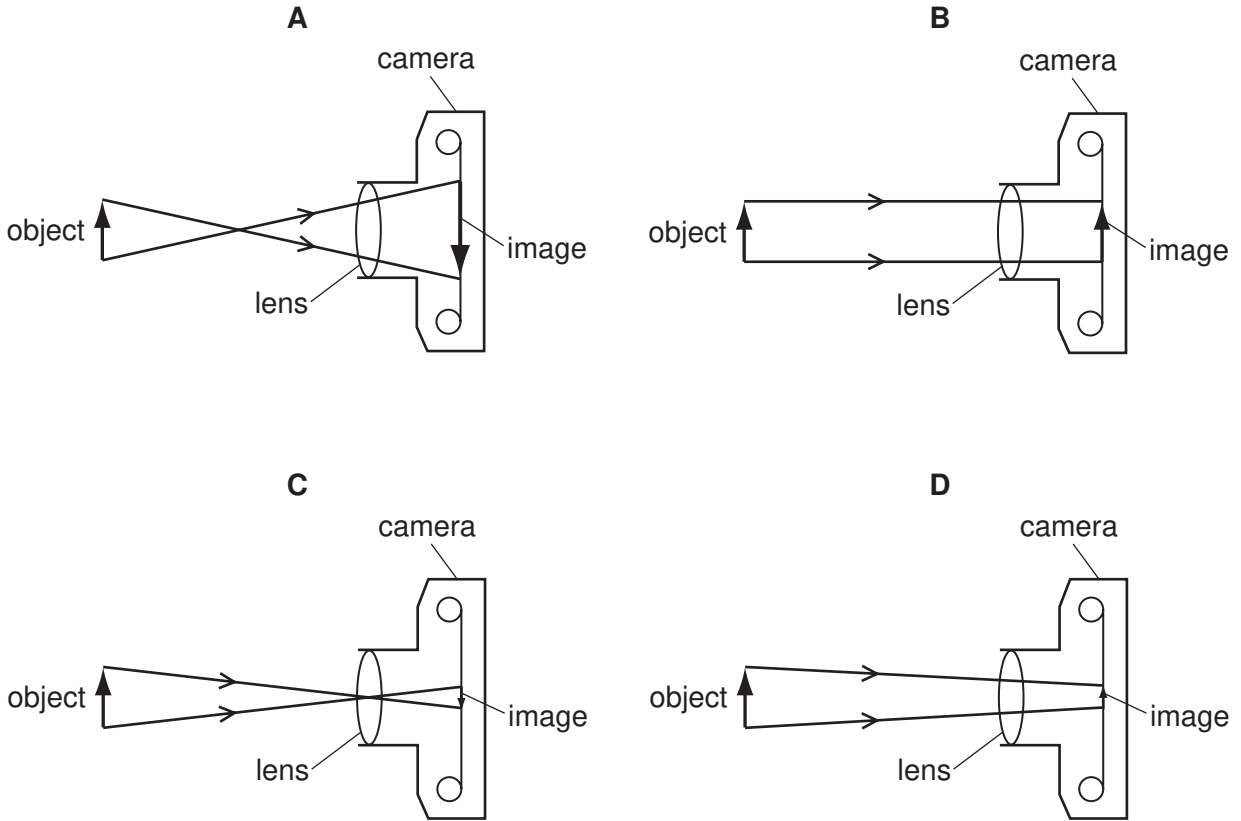

25 The diagram shows a ray of light incident on the edge of a piece of glass. The angle i is bigger than the critical angle.

Which arrow correctly shows the direction of the ray after it leaves the edge of the glass?

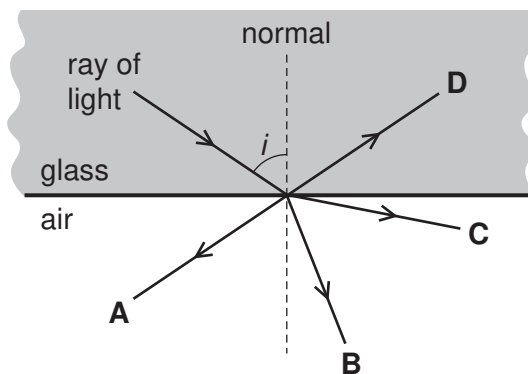

26 A magnet attracts two pieces of iron.

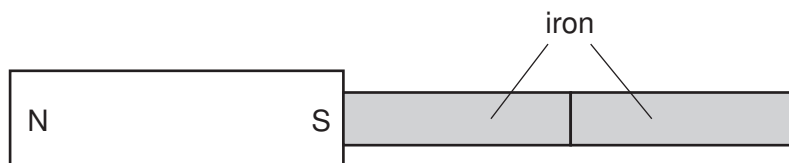

What is the arrangement of the induced poles in the pieces of iron?

A

N	S	S	N
---	---	---	---

B

N	S	N	S
---	---	---	---

C

S	N	S	N
---	---	---	---

D

S	N	N	S
---	---	---	---

27 A coil is connected to a battery and a soft iron bar is hung near to it.

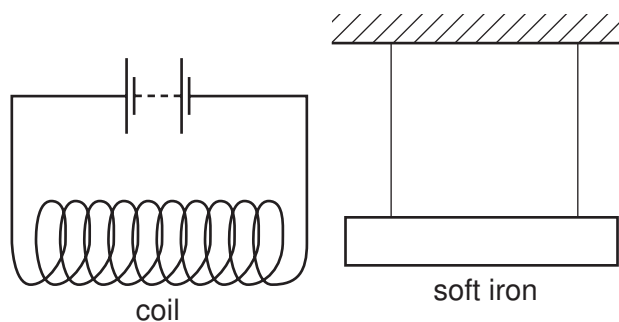

The current is then reversed by reversing the battery connections.

How does the soft iron bar behave in the two cases?

	with the battery as shown	with the battery reversed
A	attracted to the coil	attracted to the coil
B	attracted to the coil	repelled from the coil
C	repelled from the coil	attracted to the coil
D	repelled from the coil	repelled from the coil

28 A piece of iron and a piece of steel are picked up by an electromagnet as shown.

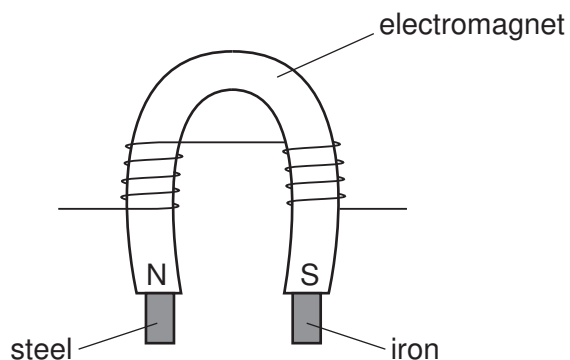

The current to the electromagnet is switched off.

What happens?

- A Both the iron and the steel remain magnetised.
- B Neither the iron nor the steel remain magnetised.
- C Only the iron remains magnetised.
- D Only the steel remains magnetised.

29 A lamp is connected in four circuits in turn, each using identical batteries.

The resistors are all identical.

In which circuit will the lamp be brightest?

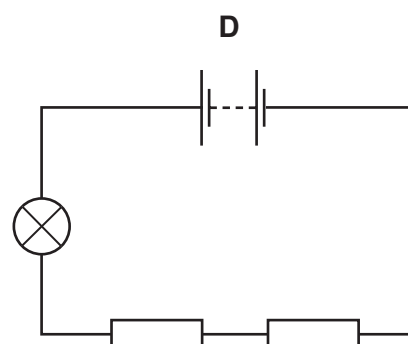
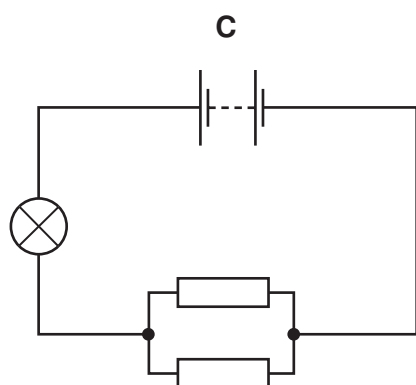
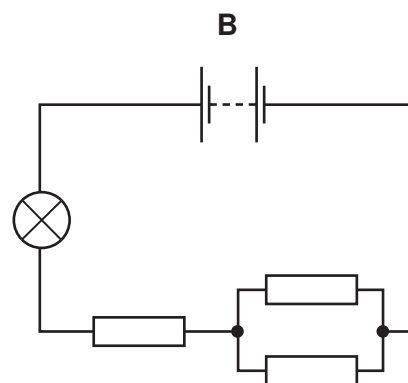
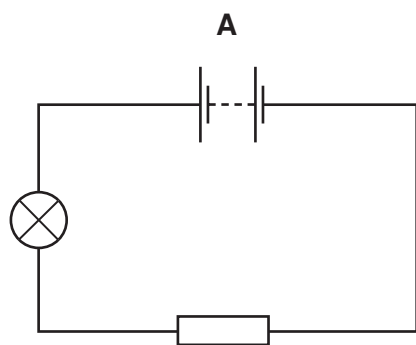

- 30 A circuit is set up to measure the resistance of a resistor R. The meter readings are 2.0 A and 3.0 V.

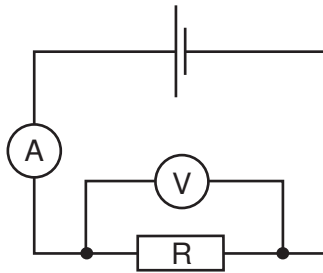

What is the resistance of the resistor R?

- A 0.67 Ω B 1.5 Ω C 5.0 Ω D 6.0 Ω
- 31 The table shows the lengths and diameters of four copper wires.

Which wire has the **least** resistance?

	length/m	diameter/mm
A	0.50	1.0
B	0.50	2.5
C	0.75	1.0
D	0.75	2.5

- 32 The circuit shown is a potential divider.

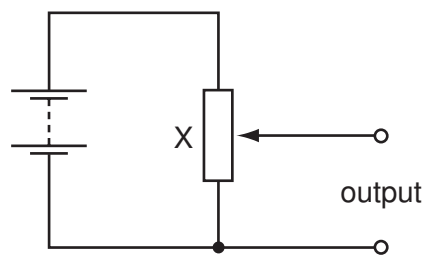

What is component X?

- A a light-dependent resistor
 B a relay
 C a thermistor
 D a variable resistor

33 A transformer has 15 000 turns on its primary coil and 750 turns on its secondary coil.

Connected in this way, for what purpose could this transformer be used?

- A** to convert the 8000 V a.c. output of a power station to 160 000 V for long-distance power transmission
- B** to convert the 160 000V d.c. supply from a power line to 8000V for local power transmission
- C** to use a 12V d.c. supply to operate a 240V razor
- D** to use a 240V a.c. mains supply to operate a 12V motor

34 After some building work in a house, a bare (uninsulated) live wire is left protruding from a wall.

What is the greatest hazard?

- A** a fire
- B** a fuse will blow
- C** an electric shock
- D** no current will flow

35 Which diagram shows the correct positions for both the switch and the fuse?

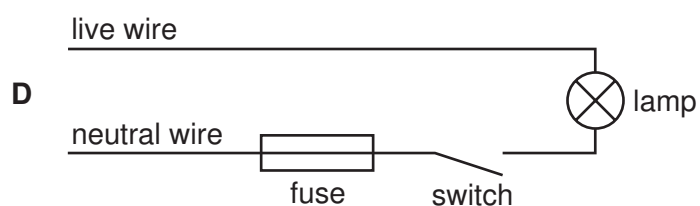
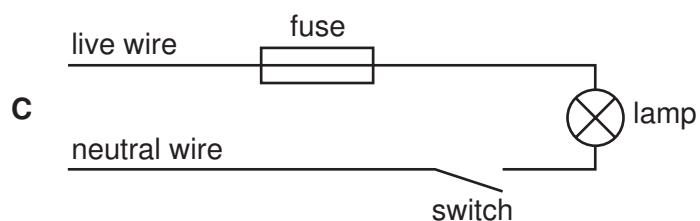
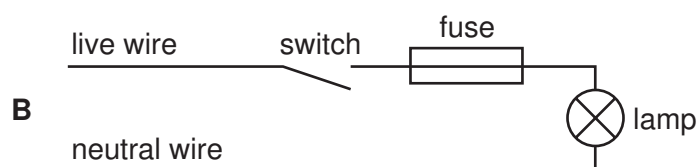
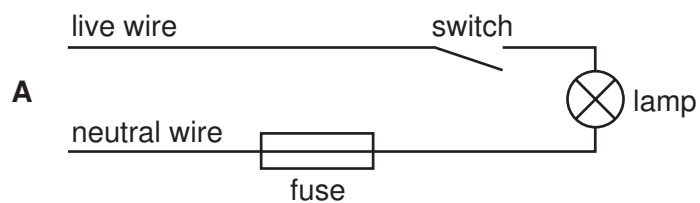

36 The nuclide notation for radium-226 is ${}^{226}_{88}\text{Ra}$.

How many electrons orbit the nucleus of a neutral atom of radium-226?

- A** 0 **B** 88 **C** 138 **D** 226

37 A radioactive substance has a half-life of 2 weeks. At the beginning of an investigation the substance emits 3000 β -particles per minute.

How many β -particles will it emit per minute after 6 weeks?

- A** 0 **B** 375 **C** 500 **D** 1500

38 Which row describes the properties of α -particles?

	ionizing effect	radiation stopped by aluminium?
A	large	no
B	large	yes
C	small	no
D	small	yes

39 What are cathode rays?

- A** a beam of electrons
- B** a beam of neutrons
- C** a beam of protons
- D** electromagnetic waves

40 A cathode-ray tube has an anode and an earthed cathode.

Which row shows the charge on the **anode** and the temperature of the **cathode**?

	anode charge	cathode temperature
A	negative	cool
B	negative	hot
C	positive	cool
D	positive	hot

BLANK PAGE

Permission to reproduce items where third-party owned material protected by copyright is included has been sought and cleared where possible. Every reasonable effort has been made by the publisher (UCLES) to trace copyright holders, but if any items requiring clearance have unwittingly been included, the publisher will be pleased to make amends at the earliest possible opportunity.

University of Cambridge International Examinations is part of the Cambridge Assessment Group. Cambridge Assessment is the brand name of University of Cambridge Local Examinations Syndicate (UCLES), which is itself a department of the University of Cambridge.