



Cambridge International Examinations
Cambridge International General Certificate of Secondary Education

PHYSICS

0625/12

Paper 1 Multiple Choice

May/June 2014

45 minutes

Additional Materials: Multiple Choice Answer Sheet
Soft clean eraser
Soft pencil (type B or HB recommended)

* 7 1 2 4 8 0 9 1 5 9 *

READ THESE INSTRUCTIONS FIRST

Write in soft pencil.

Do not use staples, paper clips, glue or correction fluid.

Write your name, Centre number and candidate number on the Answer Sheet in the spaces provided unless this has been done for you.

DO NOT WRITE IN ANY BARCODES.

There are **forty** questions on this paper. Answer **all** questions. For each question there are four possible answers **A, B, C** and **D**.

Choose the **one** you consider correct and record your choice in **soft pencil** on the separate Answer Sheet.

Read the instructions on the Answer Sheet very carefully.

Each correct answer will score one mark. A mark will not be deducted for a wrong answer.

Any rough working should be done in this booklet.

Electronic calculators may be used.

The syllabus is approved for use in England, Wales and Northern Ireland as a Cambridge International Level 1/Level 2 Certificate.

This document consists of **19** printed pages and **1** blank page.

- 1 The diagram shows part of a ruler. The ruler is used to find the length of a nail.

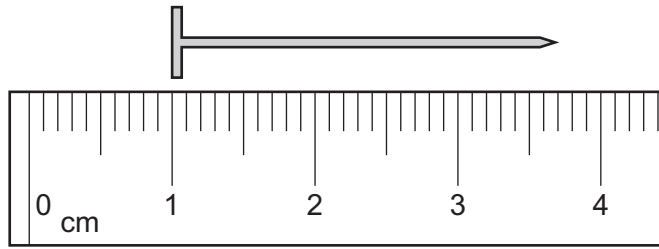

What is the length of the nail?

- A** 2.2 cm **B** 2.7 cm **C** 3.2 cm **D** 3.7 cm
- 2 Which distance/time graph represents the motion of an object moving at constant speed?

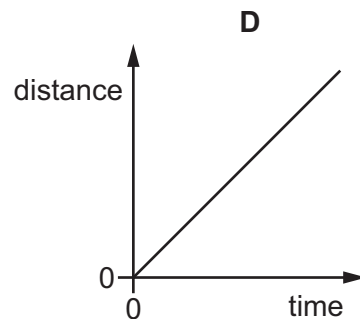
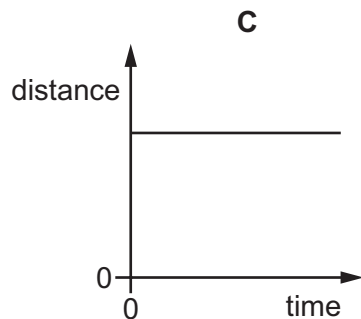
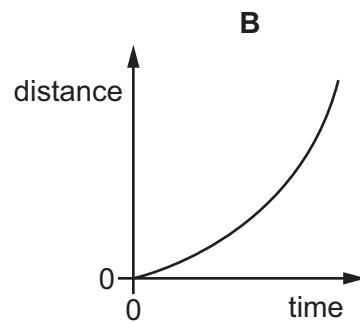
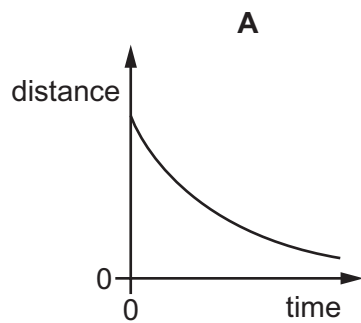

- 3 A car takes 15 minutes to travel along a road that is 20 km long.

What is the average speed of the car?

- A** 0.75 km/h **B** 5.0 km/h **C** 80 km/h **D** 300 km/h

- 4 A customer goes to a market and buys some rice. The stallholder pours rice into a dish that hangs from a spring balance. He records the reading on the spring balance.

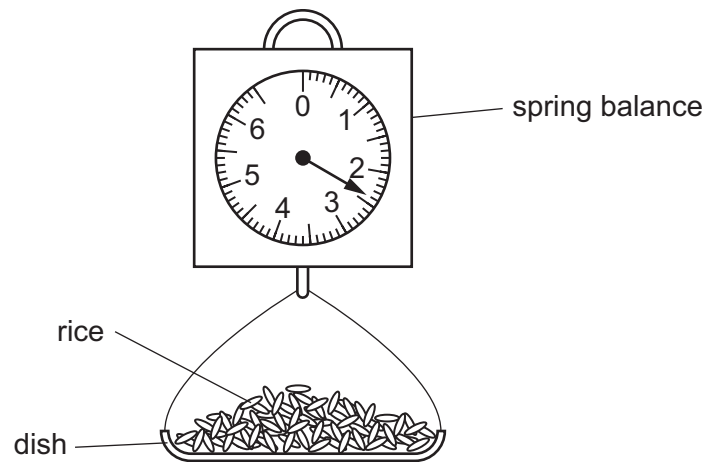

The customer then buys some pasta and the stallholder notices that the reading on the spring balance, with just pasta in the dish, is the same as it was with just rice in the dish.

The rice and the pasta must have the same

- A density.
 - B temperature.
 - C volume.
 - D weight.
- 5 The table gives the volumes and masses of four objects.

Which object has the greatest density?

	mass / g	volume / cm ³
A	5.4	2.0
B	13	3.0
C	15	6.0
D	18	5.0

- 6 A wooden bar is pivoted at its centre so that it can rotate freely. Two equal forces F are applied to the bar.

In which diagram is the turning effect greatest?

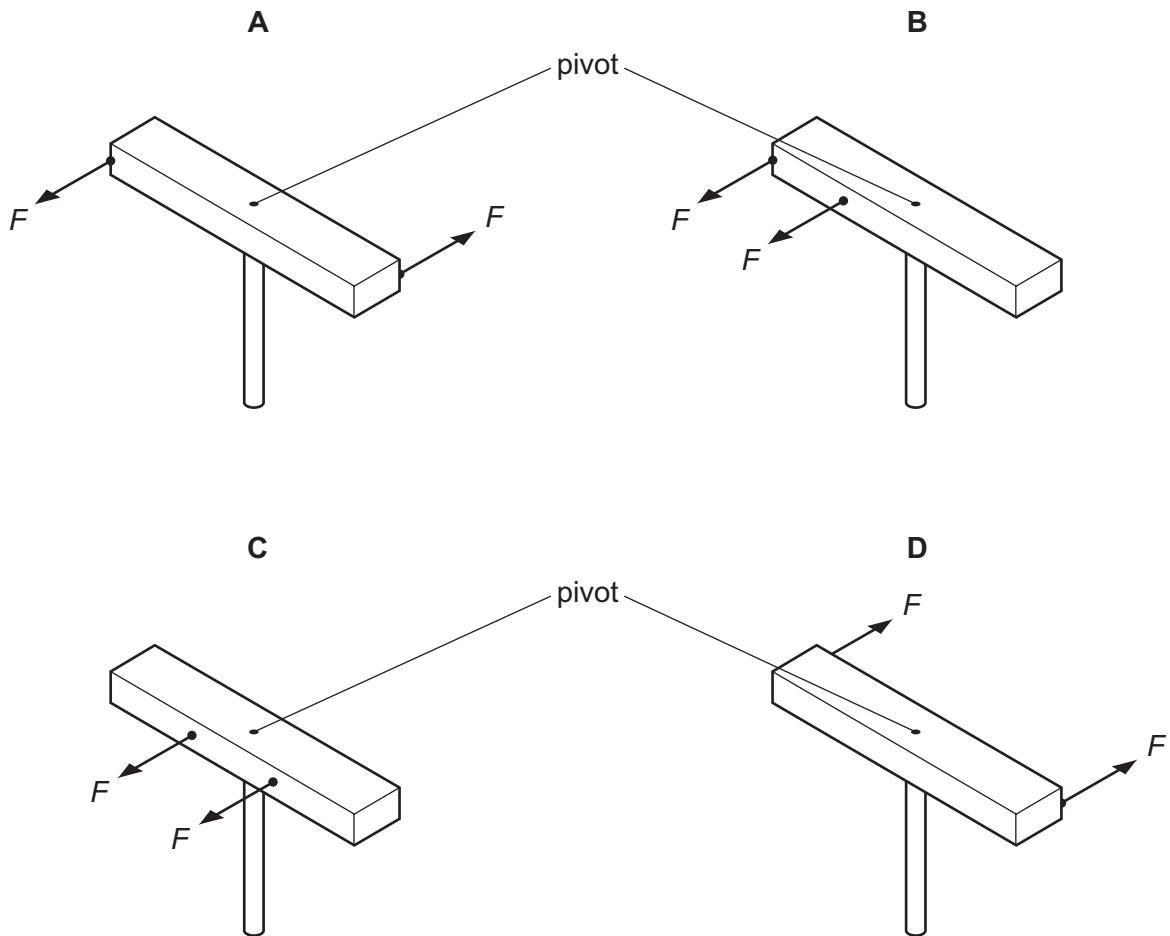

- 7 A student adds weights to an elastic cord. He measures the length of the cord for each weight. He then plots a graph from the results, as shown.

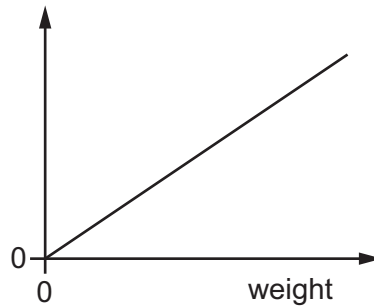

What has he plotted on the vertical axis?

- A measured length
 - B original length
 - C (measured length + original length)
 - D (measured length – original length)
- 8 In a hydroelectric power station, one form of energy is stored in a lake or reservoir. This energy is then transferred in stages to another useful form, which is the output.

Which row gives the name of the stored energy and the name of the output energy?

	stored energy	output energy
A	electrical	thermal (heat)
B	electrical	kinetic
C	gravitational	electrical
D	kinetic	electrical

- 9 A certain machine is very efficient.

What does this mean?

- A It produces a large amount of power.
- B It uses very little energy.
- C It wastes very little energy.
- D It works very quickly.

10 The diagram shows a simple mercury barometer.

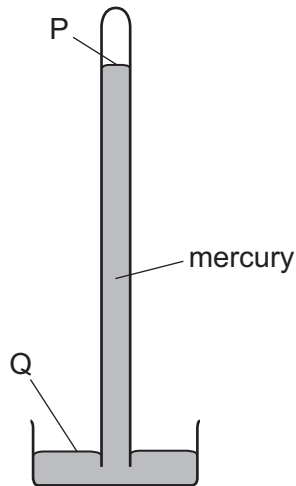

Atmospheric pressure decreases.

What happens to the level of the mercury at P and what happens to the level of the mercury at Q?

	P	Q
A	falls	falls
B	falls	rises
C	rises	falls
D	rises	rises

11 A student places four identical beakers on a bench.

Two beakers contain salt water of density 1.1 g/cm^3 and two beakers contain pure water of density 1.0 g/cm^3 .

Which beaker exerts the greatest pressure on the bench?

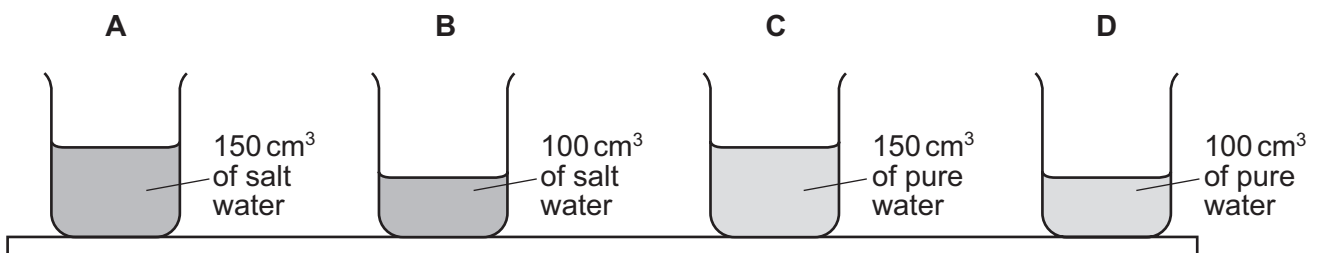

- 12 A student places his thumb firmly on the outlet of a bicycle pump, to stop the air coming out.

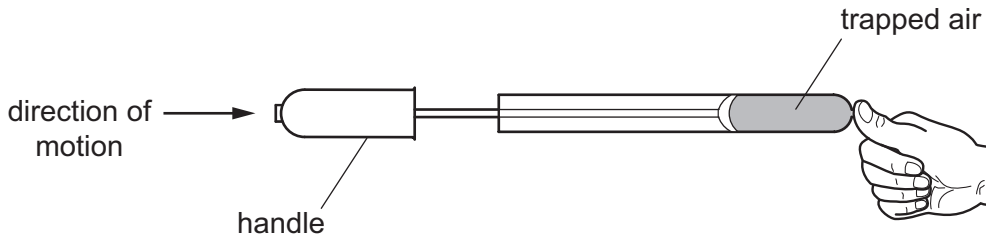

What happens to the pressure and what happens to the volume of the trapped air as the pump handle is pushed in?

	pressure	volume
A	decreases	decreases
B	decreases	remains the same
C	increases	decreases
D	increases	remains the same

- 13 The diagram represents molecules of gas moving in a container.

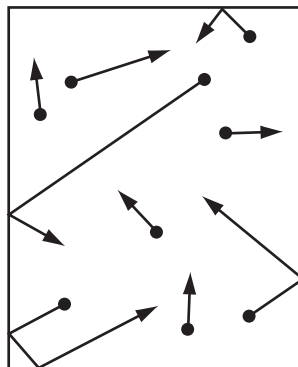

What happens to the gas molecules when the temperature of the gas increases?

- A** They move more quickly.
 - B** They move more slowly.
 - C** They vibrate more quickly.
 - D** They vibrate more slowly.
- 14 A liquid-in-glass thermometer is marked with a scale in °C.

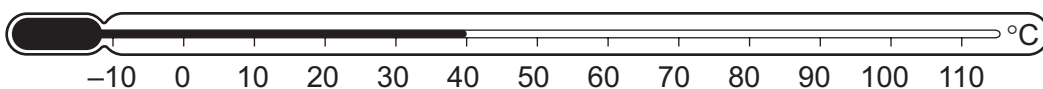

What is the temperature difference between the two fixed points for this thermometer?

- A** 40°C
- B** 50°C
- C** 100°C
- D** 120°C

- 15 Which statement gives the thermal capacity of a solid body?
- A** the energy needed to melt the body without a change in temperature
- B** the energy per degree Celsius needed to raise the temperature of the body
- C** the increase in the volume of the body when its temperature is raised by one degree Celsius
- D** the total amount of internal energy in the body
- 16 In an experiment, a thermometer is placed in a test-tube of hot liquid. The temperature of the liquid is recorded every half minute. The table shows the results.

time/minutes	0.0	0.5	1.0	1.5	2.0	2.5	3.0	3.5	4.0	4.5	5.0	5.5	6.0	6.5	7.0	7.5
temperature/°C	73	65	59	55	55	55	51	48	45	42	40	38	36	35	34	33

What is the melting point of the substance?

- A** 0°C **B** 33°C **C** 55°C **D** 73°C
- 17 The diagram shows an air-conditioning unit on the wall of a room. The unit draws in warm air from the room and releases cold air into the room.

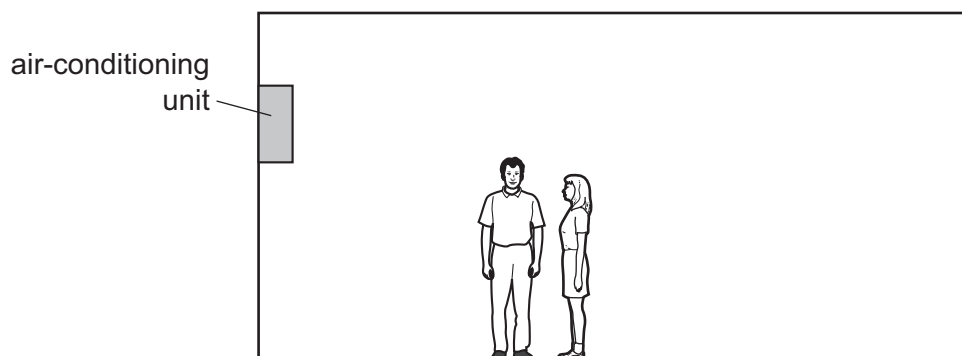

What happens to the cold air and why?

	cold air	why?
A	falls	it is less dense than warm air
B	falls	it is more dense than warm air
C	rises	it is less dense than warm air
D	rises	it is more dense than warm air

18 Which statement about thermal radiation is correct?

- A It can only occur in a vacuum.
- B It involves movement of electrons through a material.
- C It involves movement of atoms.
- D It is infra-red radiation.

19 Scout P signals to scout Q on the other side of a valley by using a mirror to reflect the Sun's rays.

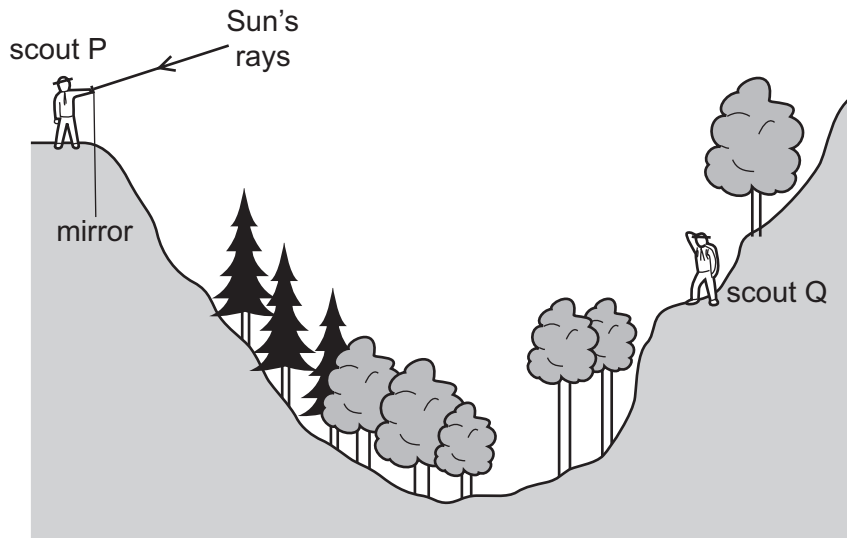

Which mirror position would allow the Sun's rays to be reflected to scout Q?

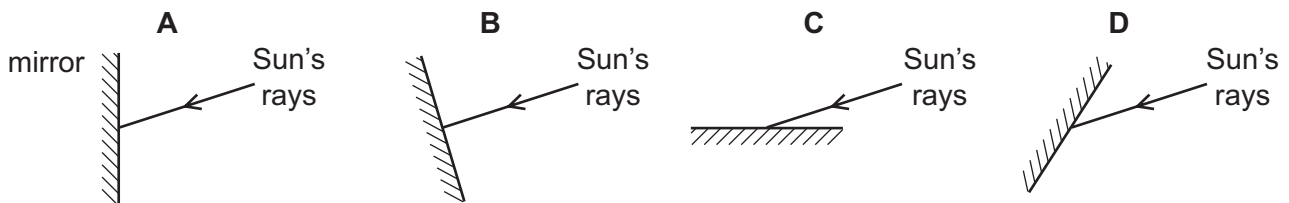

20 A small boat in a harbour is protected from waves on the sea by harbour walls.

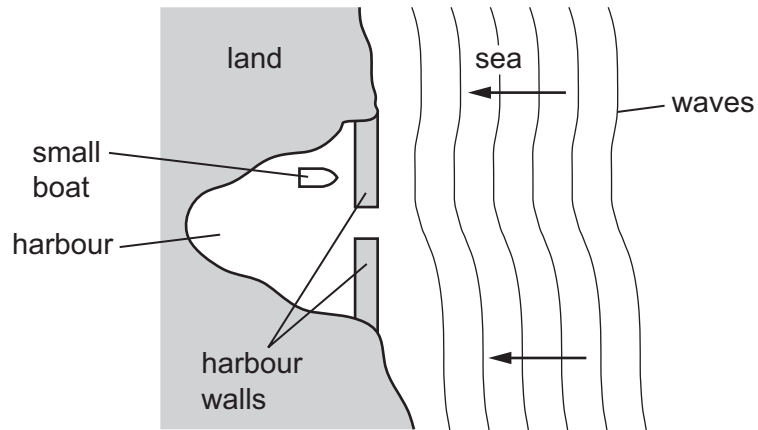

Some waves can curve round the harbour walls and reach the boat.

What is the name of this effect?

- A diffraction
 - B dispersion
 - C reflection
 - D refraction
- 21 Which statement about ultraviolet waves is correct?
- A They are used in television remote controllers.
 - B They can be detected by the human eye.
 - C They travel as longitudinal waves.
 - D They have the same speed in a vacuum as radio waves.

22 A boy wears a shirt with a letter F on the front. He stands in front of a plane mirror.

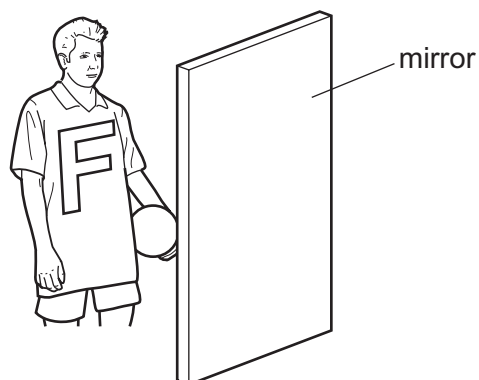

What does he see in the mirror?

A



B



C

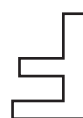

D



23 Rays of light enter and leave a box.

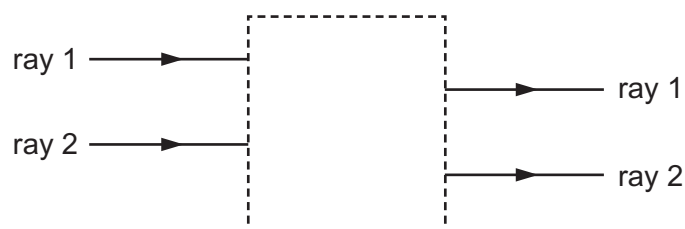

What could be inside the box to make the rays behave as shown?

- A a converging lens
- B a parallel-sided glass block
- C a plane mirror
- D a triangular prism

24 The diagrams show the wave patterns of four sounds shown on a cathode-ray oscilloscope (c.r.o.). The oscilloscope controls are set the same for each sound.

Which sound has the highest pitch?

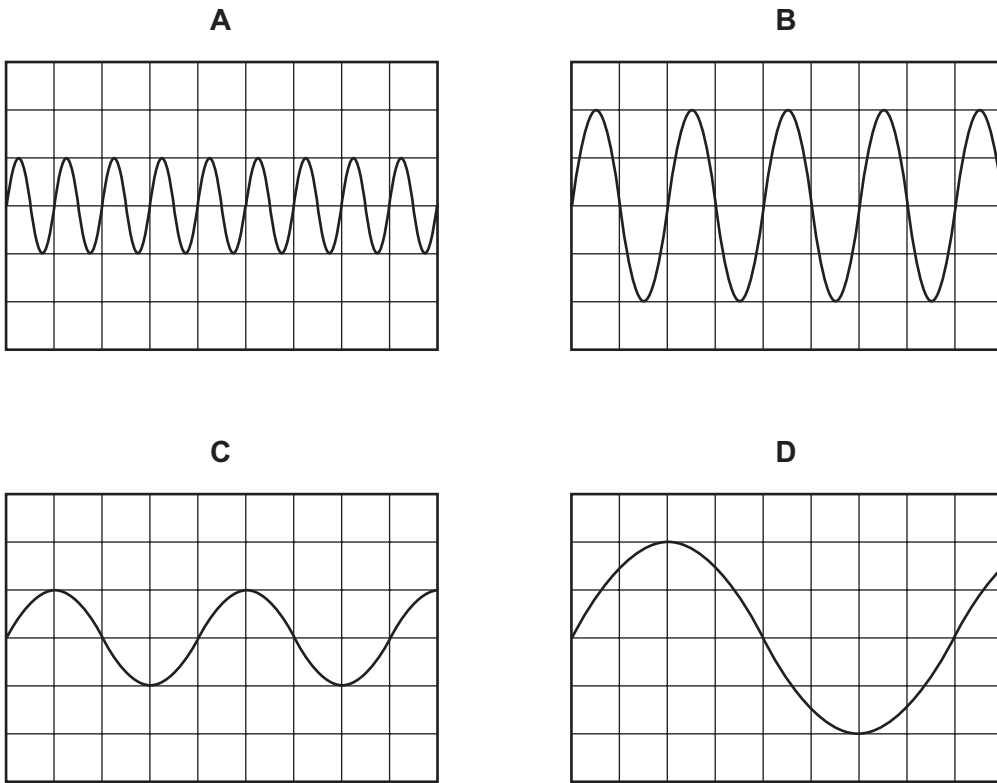

25 A lighted candle is placed in front of a loudspeaker that is making a loud, steady note. The candle flame vibrates because of the sound wave.

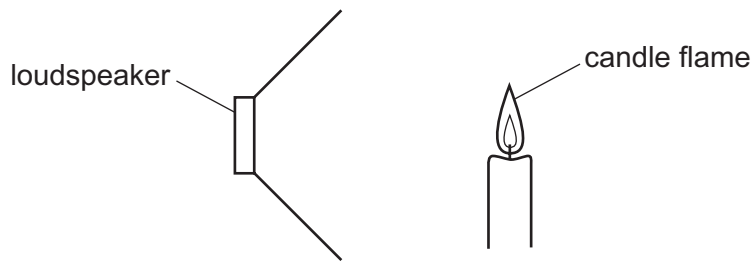

Which type of waves are sound waves and in which direction does the flame vibrate?

	type of wave	direction of vibration
A	longitudinal	↑ ↓
B	transverse	↑ ↓
C	longitudinal	← →
D	transverse	← →

26 Which row correctly shows whether copper and steel are ferrous or non-ferrous?

	copper	steel
A	ferrous	ferrous
B	ferrous	non-ferrous
C	non-ferrous	ferrous
D	non-ferrous	non-ferrous

27 A steel magnet is placed inside a coil of wire. There is a large alternating current in the coil. The magnet is slowly moved out of the coil to position P.

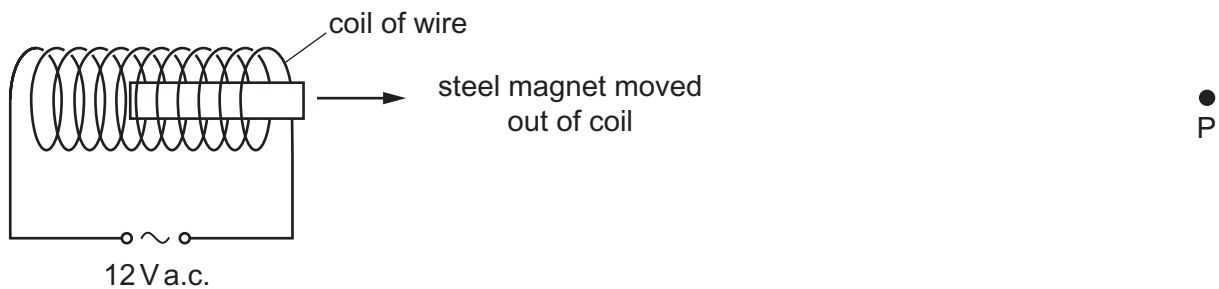

How has the steel changed, if at all, when it reaches position P?

- A** It has become a stronger magnet.
- B** It has become demagnetised.
- C** The poles have changed ends.
- D** There has been no change.

- 28 Two balloons, X and Y, are suspended by insulating threads. They are each held near a negatively charged balloon. The balloons hang as shown.

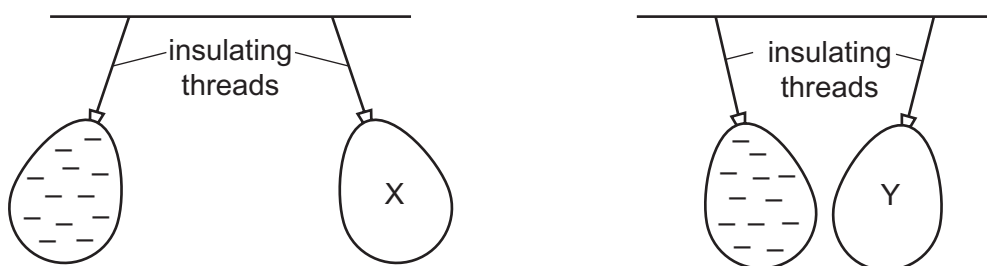

What is the charge on balloon X and what is the charge on balloon Y?

	balloon X	balloon Y
A	negative	negative
B	negative	positive
C	positive	negative
D	positive	positive

- 29 Which quantities is a voltmeter used to measure?

- A** current and e.m.f. only
- B** current and p.d. only
- C** e.m.f. and p.d. only
- D** e.m.f., current and p.d

- 30 The diagram shows a lamp and a resistor connected in a circuit. The lamp is too bright.

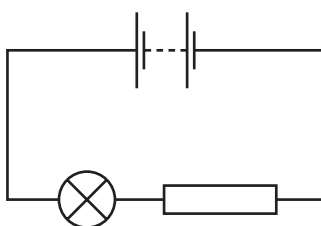

Which change to the circuit will decrease the current in the lamp and make it less bright?

- A** connecting another resistor in parallel with the one in the circuit
- B** connecting another resistor in series with the one in the circuit
- C** exchanging the positions of the lamp and the resistor in the circuit
- D** increasing the e.m.f. of the battery in the circuit

31 Which statement is **not** correct for lamps connected in parallel?

- A They can be switched on and off separately.
- B They will remain bright if another lamp is connected in parallel.
- C They share the supply voltage equally between them.
- D They still operate if one lamp is removed.

32 A student connects a circuit using an uncharged capacitor C , with a large capacitance, and a resistor R , with a high resistance.

The switch is closed. The reading on the voltmeter P rises immediately to a maximum value, then starts to fall gradually.

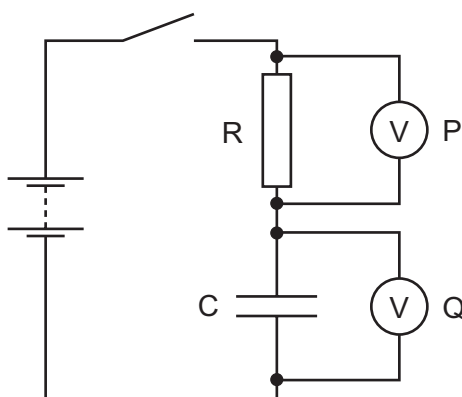

What happens to the reading on the voltmeter Q and what happens to the energy stored in the capacitor?

	reading on voltmeter Q	energy stored in capacitor
A	falls	decreases
B	falls	increases
C	rises	decreases
D	rises	increases

33 Which labelled component in the circuit shown controls the brightness of lamp X?

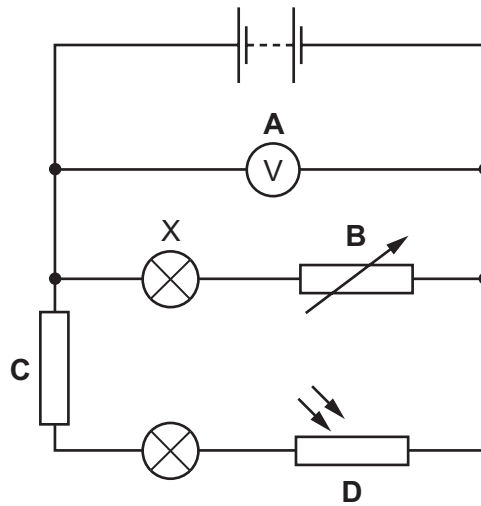

34 In the circuit shown, the current from the battery divides equally between the two lamps. Each ammeter reads 6.0 A.

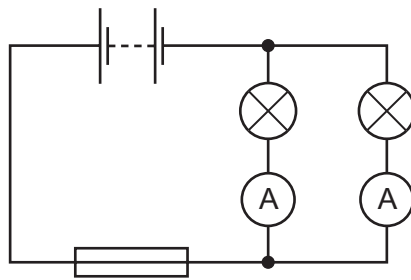

What is a suitable rating for the fuse in this circuit?

- A** 3.0 A **B** 6.0 A **C** 10.0 A **D** 13.0 A

35 A metal wire is placed between the poles of a magnet.

The wire can be moved in each of three directions OP, QR and ST.

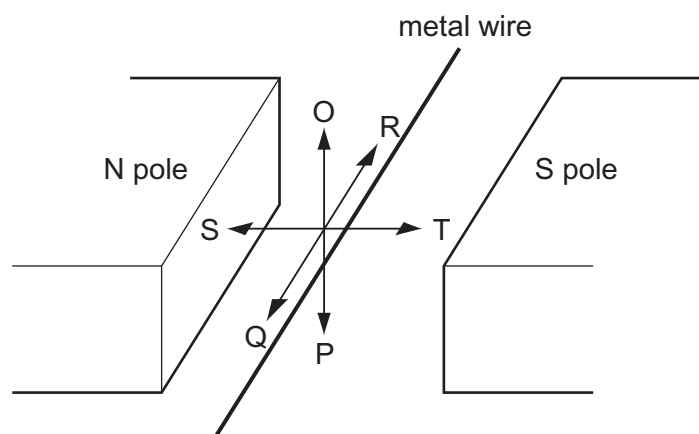

In which direction or directions must the wire be moved to induce an e.m.f. across the ends of the wire?

- A** OP only **B** OP or ST **C** QR **D** ST only

36 A transformer has 100 turns on its primary coil and 25 turns on its secondary coil. The primary coil is connected to a 12 V a.c. supply.

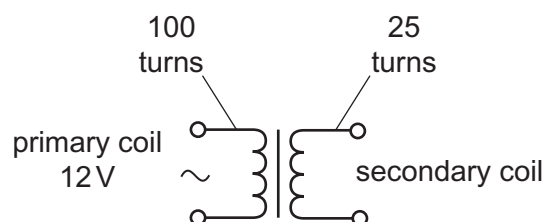

What is the voltage induced across the secondary coil?

- A** 3.0V **B** 4.0V **C** 48V **D** 300V

- 37 A beam of cathode rays passes between two parallel metal plates connected to a high-voltage d.c. power supply.

Which path does the beam follow?

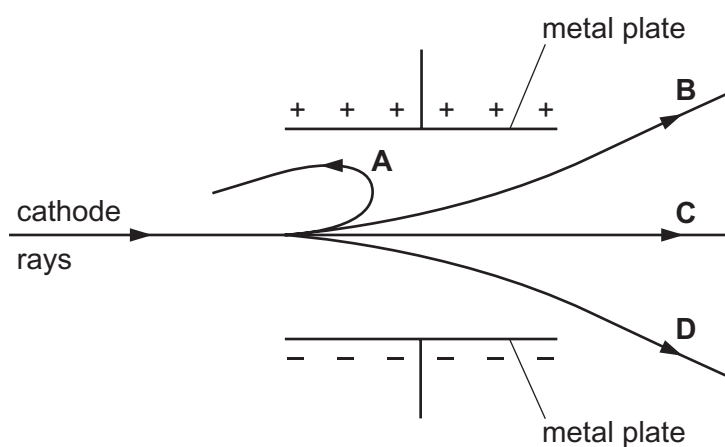

- 38 Compared with β -particles and γ -rays, α -particles

- A are the only type of radiation to carry a charge.
- B have the greatest ionising effect.
- C have the greatest penetrating effect.
- D have the smallest mass.

- 39 The diagram shows a box used for storing radioactive sources.

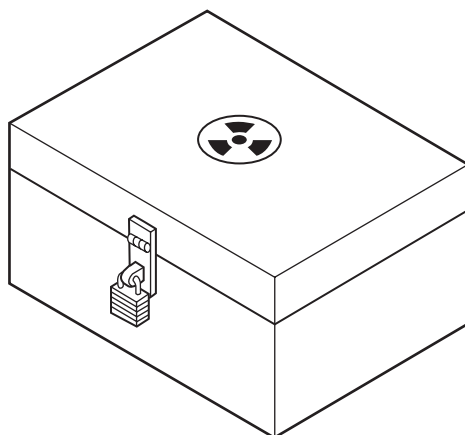

Which material is best for lining the box to prevent the escape of most radioactive emissions?

- A aluminium
- B copper
- C lead
- D steel

40 A particular nuclide of chlorine can be represented by the symbol shown.



How many electrons are there in a neutral atom of this nuclide?

A 17

B 20

C 37

D 54

BLANK PAGE

Permission to reproduce items where third-party owned material protected by copyright is included has been sought and cleared where possible. Every reasonable effort has been made by the publisher (UCLES) to trace copyright holders, but if any items requiring clearance have unwittingly been included, the publisher will be pleased to make amends at the earliest possible opportunity.

Cambridge International Examinations is part of the Cambridge Assessment Group. Cambridge Assessment is the brand name of University of Cambridge Local Examinations Syndicate (UCLES), which is itself a department of the University of Cambridge.