



Cambridge International Examinations
Cambridge International General Certificate of Secondary Education

CANDIDATE NAME

CENTRE NUMBER

CANDIDATE NUMBER



PHYSICS

0625/62

Paper 6 Alternative to Practical

October/November 2015

1 hour

Candidates answer on the Question Paper.

No Additional Materials are required.

READ THESE INSTRUCTIONS FIRST

Write your Centre number, candidate number and name on all the work you hand in.

Write in dark blue or black pen.

You may use an HB pencil for any diagrams or graphs.

Do not use staples, paper clips, glue or correction fluid.

DO NOT WRITE IN ANY BARCODES.

Answer **all** questions.

Electronic calculators may be used.

You may lose marks if you do not show your working or if you do not use appropriate units.

At the end of the examination, fasten all your work securely together.

The number of marks is given in brackets [] at the end of each question or part question.

The syllabus is approved for use in England, Wales and Northern Ireland as a Cambridge International Level 1/Level 2 Certificate.

This document consists of **14** printed pages and **2** blank pages.

- 1 The class is investigating the masses of two loads, **P** and **Q**.

Fig. 1.1 shows the apparatus.

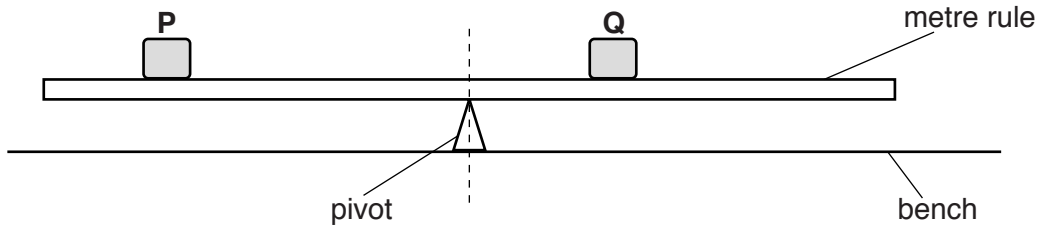

Fig. 1.1

- (a) A student places the metre rule on the pivot at the 50.0 cm mark.

He places the load **P** on the metre rule. He then places the load **Q** on the metre rule and adjusts its position so that the metre rule is as near as possible to being balanced.

- (i) On Fig. 1.1, measure the distance x from the centre of load **P** to the pivot.

$x =$

- (ii) On Fig. 1.1, measure the distance y from the pivot to the centre of load **Q**.

$y =$

[1]

- (iii) Fig. 1.1 is drawn 1/10th full size.

Calculate the actual distance a from the centre of load **P** to the pivot. Calculate the actual distance b from the pivot to the centre of load **Q**. Write the results in Table 1.1. [1]

Table 1.1

a/cm	b/cm
35.0	17.6
30.0	14.8
25.0	12.7
20.0	10.1

- (b) The student repeats the procedure using different positions of **P**. His readings are shown in the table.

Plot a graph of b/cm (y -axis) against a/cm (x -axis).

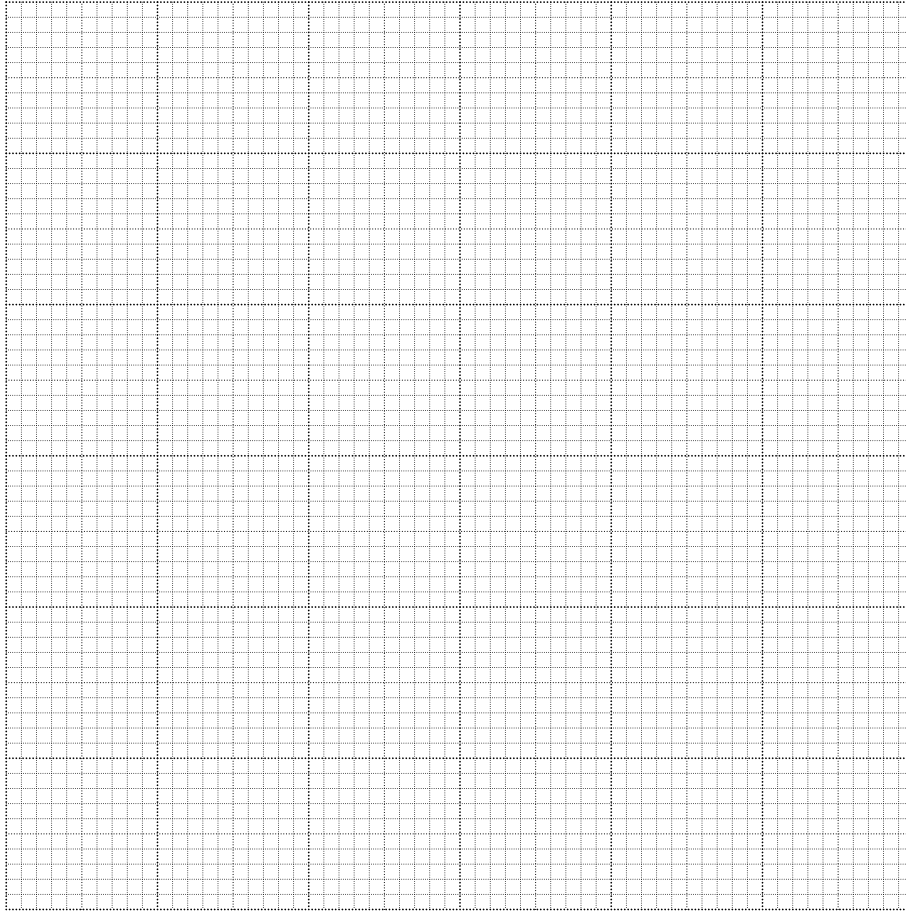

[4]

- (c) Determine the gradient G of the graph. Show clearly on the graph how you obtained the necessary information.

$G = \dots\dots\dots$ [2]

- (d) The gradient G is the ratio of the masses of the two loads **P** and **Q**.

Suggest a suitable value for the mass of **P** in this experiment. Use this, and your value for G , to determine an estimate for the mass of **Q**.

estimated mass of **P** =

estimated mass of **Q** =

[2]

[Total: 10]
[Turn over

2 The class is investigating the cooling of a thermometer bulb.

Figs. 2.1 and 2.2 show the apparatus.

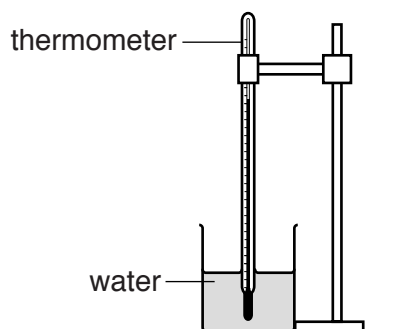

Fig. 2.1

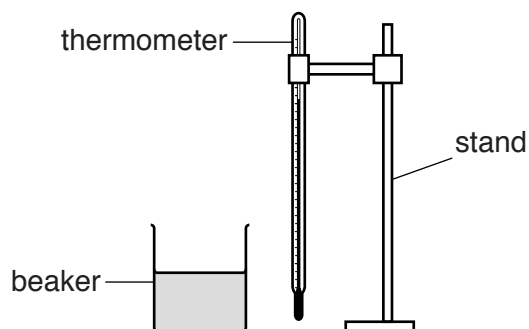

Fig. 2.2

(a) In the space in Table 2.1, record the temperature θ_1 of the hot water as shown on the thermometer in Fig. 2.3.

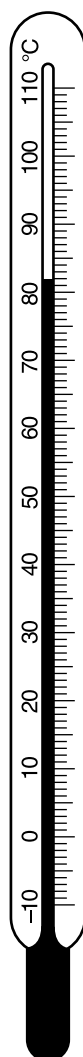

Fig. 2.3

[1]

- (b) A student removes the thermometer from the beaker of hot water, as shown in Fig. 2.2. She immediately starts a stopclock, and records the temperature θ_1 every 10s for 1 minute. The temperature readings are shown in Table 2.1.

Table 2.1

$t/$	$\theta_1/$	$\theta_2/$
0		33
	72	30
	65	28
	59	27
	53	26
	48	26
	43	25

She then adds 100cm^3 of cold water to the water in the beaker and repeats the procedure. She records the temperature readings in the θ_2 column of the table.

(i) Complete the column headings in the table.

(ii) Record the time readings in the table.

[2]

- (c) (i) Using the readings in the θ_1 column of the table, calculate the decrease in temperature $\Delta\theta_1$ in 60s.

$$\Delta\theta_1 = \dots\dots\dots$$

- (ii) Using the readings in the θ_2 column of the table, calculate the decrease in temperature $\Delta\theta_2$ in 60s.

$$\Delta\theta_2 = \dots\dots\dots$$

- (iii) State the reason why $\Delta\theta_2$ is less than $\Delta\theta_1$.

.....

[2]

- (d) State a precaution that you would take when reading the thermometer scale in order to obtain reliable readings.

.....[1]

(e) Suggest **one** reason why other students, carrying out this experiment with care, might obtain values of $\Delta\theta_1$ and $\Delta\theta_2$ different from the values in part (c).

.....

.....[1]

[Total: 7]

3 The class is investigating the combined resistance of resistors in series and parallel arrangements.

The circuit is shown in Fig. 3.1.

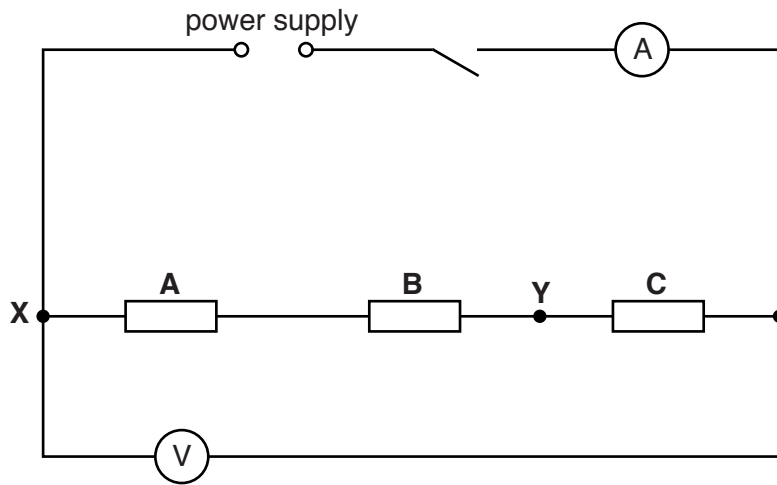

Fig. 3.1

(a) (i) Record the potential difference V_1 across the resistors and the current I_1 in the circuit, as shown in Figs. 3.2 and 3.3.

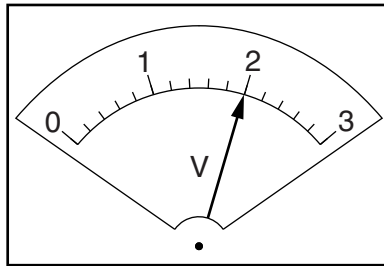

Fig. 3.2

$V_1 = \dots\dots\dots$

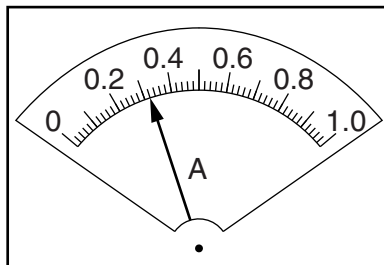

Fig. 3.3

$I_1 = \dots\dots\dots$ [2]

- (ii) Calculate the combined resistance R_1 of the resistors using the equation $R_1 = \frac{V_1}{I_1}$.

$$R_1 = \dots\dots\dots[1]$$

(b) A student rearranges the circuit shown in Fig. 3.1. He follows these instructions:

- Disconnect resistors **A** and **B**.
- Connect together the resistors **A** and **B** in parallel.
- Connect one side of this parallel combination to the resistor **C** at the point labelled **Y** in Fig. 3.1.
- Connect the other side of the parallel combination to the point labelled **X** in Fig. 3.1.
- Do not make any other changes to the circuit.

On Fig. 3.4, complete the diagram of this new circuit using standard circuit symbols.

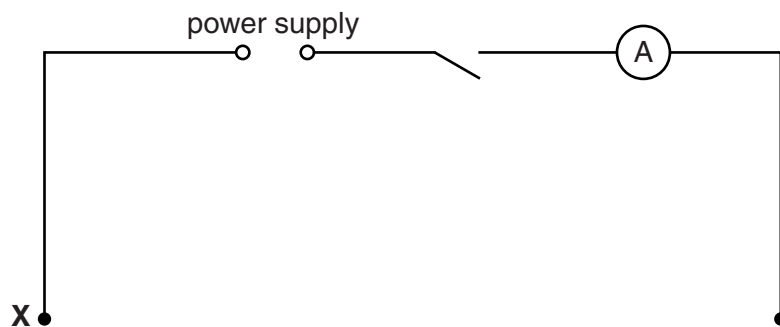

Fig. 3.4

[2]

- (c) Using the new circuit, a student measures the potential difference V_2 across the three resistors and the current I_2 in the circuit.

$$V_2 = \dots\dots\dots 2.1\text{V}$$

$$I_2 = \dots\dots\dots 0.69\text{A}$$

- (i) Calculate the combined resistance R_2 of the resistors using the equation $R_2 = \frac{V_2}{I_2}$.

$$R_2 = \dots\dots\dots$$

- (ii) Calculate the ratio $\frac{R_1}{R_2}$.

$$\frac{R_1}{R_2} = \dots\dots\dots [2]$$

- (d) R_1 should equal $2 \times R_2$ when all three resistors are identical.

State whether the results indicate that the resistors are identical. Justify your answer by reference to the results.

statement

justification

.....

.....

[2]

[Total: 9]

- 4 The class is investigating reflection using a plane mirror.

Fig. 4.1 shows a student's ray-trace sheet.

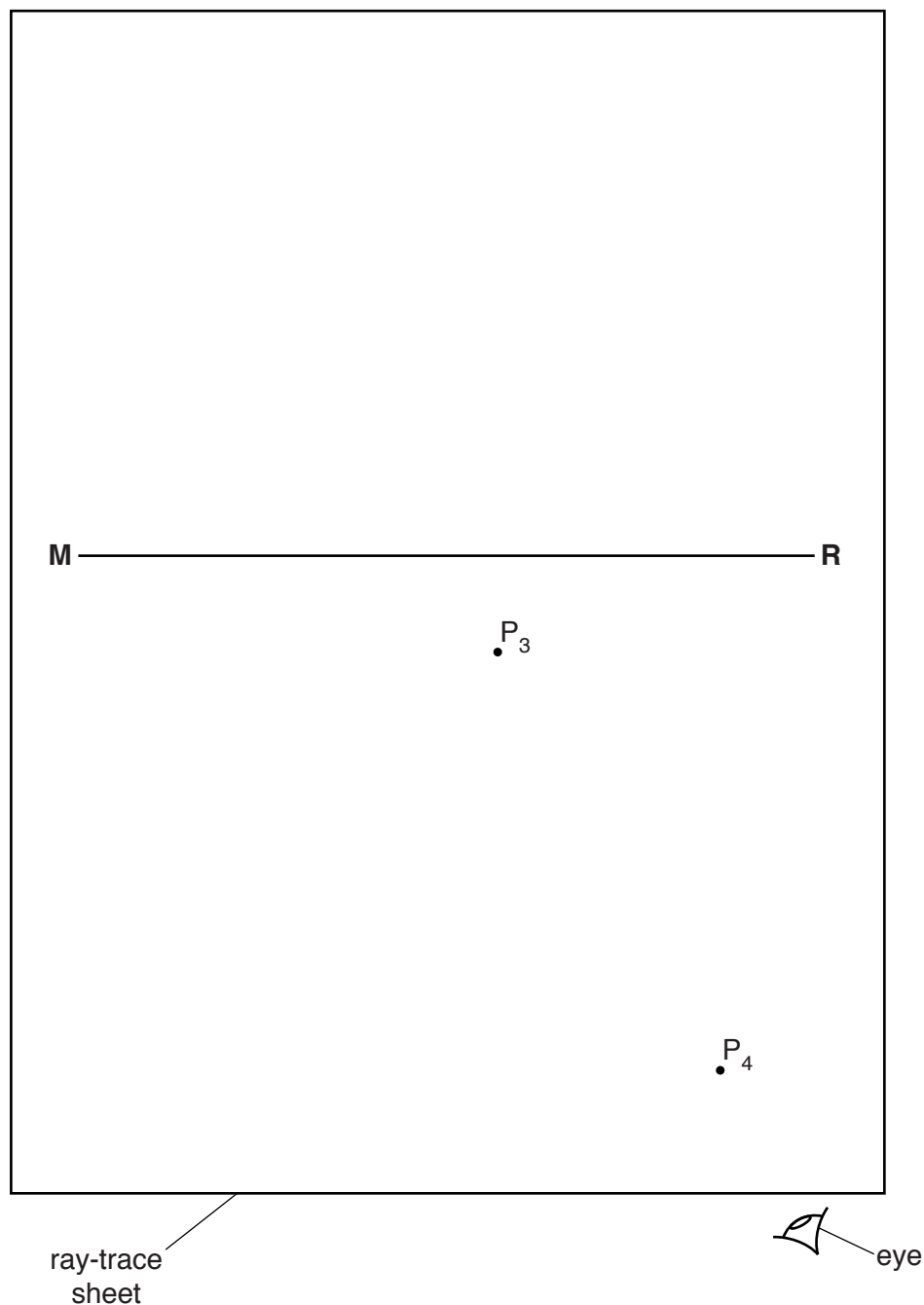

Fig. 4.1

- (a) The student draws the line **MR** to mark the position of a plane mirror.
- (i) On Fig. 4.1, draw a normal to this line that passes through its centre. Label the normal **NL**. Label the point at which **NL** crosses **MR** with the letter **A**.
- (ii) Draw a line 8.0 cm long from **A** at an angle of incidence $i = 30^\circ$ to the normal, below **MR** and to the left of the normal. Label the end of this line **B**.

[3]

(b) The student places a pin P_1 at point **B**. She places a second pin P_2 on line **AB**.

Label a position **X** on line **AB** to show a suitable position for pin P_2 . [1]

(c) She views the images of pins P_1 and P_2 from the direction indicated by the eye in Fig. 4.1. She places two pins P_3 and P_4 , some distance apart, so that pins P_3 and P_4 , and the images of P_2 and P_1 , all appear exactly one behind the other. The positions of P_3 and P_4 are shown in Fig. 4.1.

(i) Draw the line joining the positions of P_3 and P_4 . Extend the line until it meets **NL**.

(ii) Measure the angle r between **NL** and the line joining the positions of P_3 and P_4 .

$r = \dots\dots\dots$ [2]

(d) State two precautions that you would take with the pins in this experiment in order to obtain reliable readings.

1.
.....
2.
.....

[2]

- (e) The student turns the ray-trace sheet through 180°. She draws a line **AC** at an angle of incidence $i = 30^\circ$ to the normal, below **MR** and to the right of the normal.

She repeats the procedure described in parts (b) and (c). Her ray-trace is shown in Fig. 4.2.

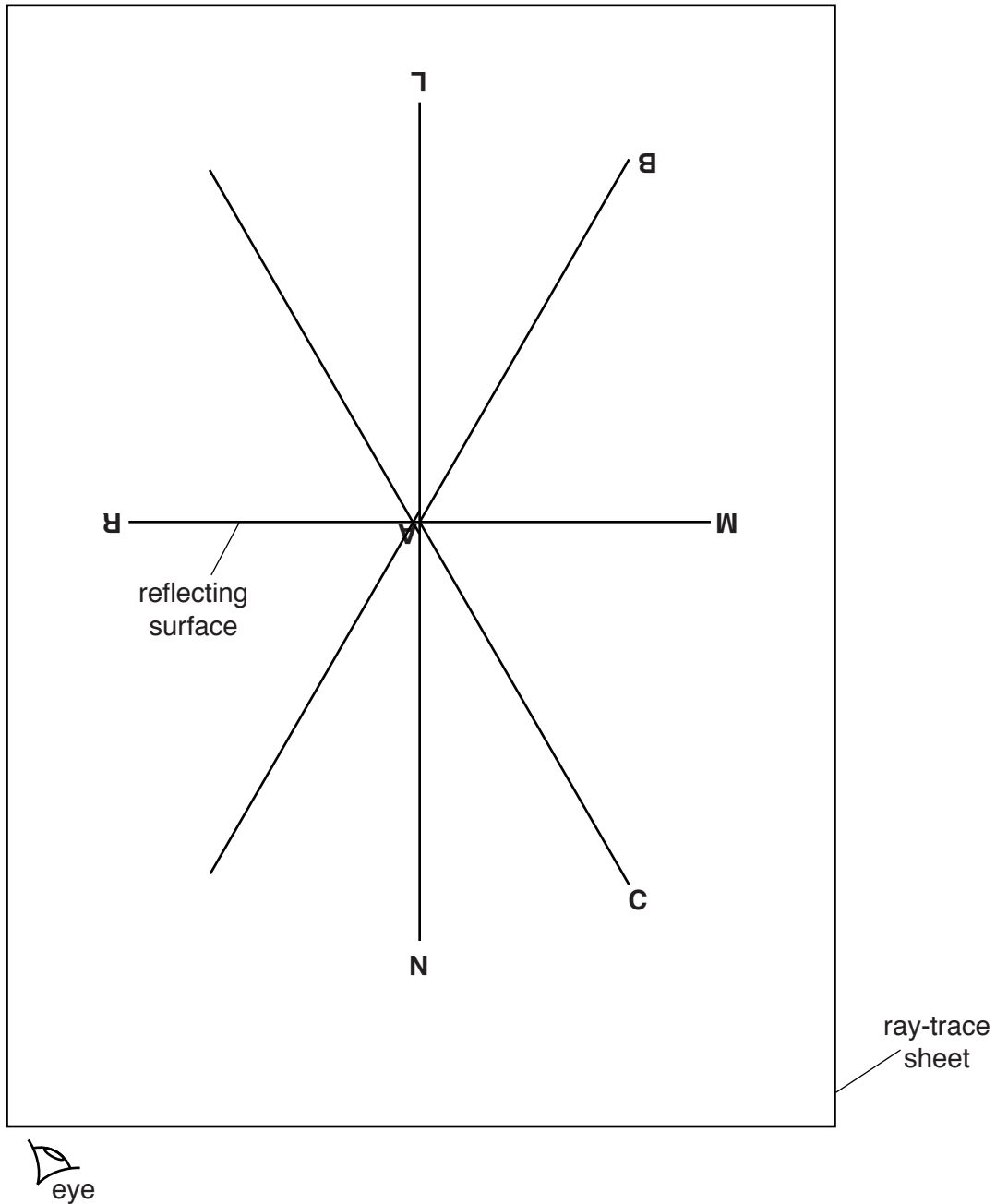

Fig. 4.2

She carried out the experiment very carefully. She expected that the results would show all the incident rays and reflected rays meeting at point **A**.

Suggest a practical reason why the lines may not meet exactly at point **A**.

.....
[1]

[Total: 9]

- 5 The class is investigating the motion of a small steel ball when it is dropped on to a tray full of sand. Fig. 5.1 shows the apparatus.

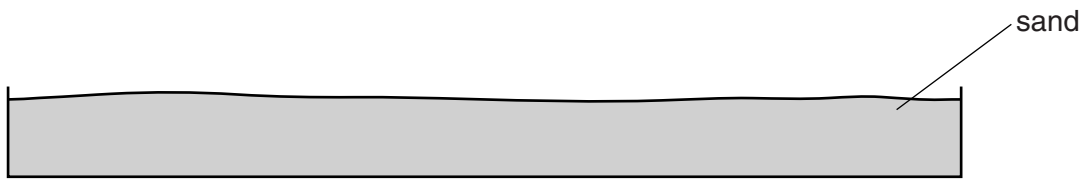

Fig. 5.1

- (a) A student is measuring the time it takes for the steel ball to fall through 2.00 m on to the sand. He uses a stopwatch.

Suggest a cause of inaccuracy in the timing.

.....
.....[1]

- (b) When the steel ball falls into the sand it creates a circular hole.

Suggest how you would measure the diameter of the hole as reliably as possible. Name the measuring device that you would use. You may draw a diagram.

.....
.....
.....[2]

- (c) The student suggests that the diameter of the hole depends on the height from which the ball is dropped, because this affects the speed.

Suggest two other variables on which the size of the hole may depend.

1.

2.

[2]

[Total: 5]

BLANK PAGE

Permission to reproduce items where third-party owned material protected by copyright is included has been sought and cleared where possible. Every reasonable effort has been made by the publisher (UCLES) to trace copyright holders, but if any items requiring clearance have unwittingly been included, the publisher will be pleased to make amends at the earliest possible opportunity.

To avoid the issue of disclosure of answer-related information to candidates, all copyright acknowledgements are reproduced online in the Cambridge International Examinations Copyright Acknowledgements Booklet. This is produced for each series of examinations and is freely available to download at www.cie.org.uk after the live examination series.

Cambridge International Examinations is part of the Cambridge Assessment Group. Cambridge Assessment is the brand name of University of Cambridge Local Examinations Syndicate (UCLES), which is itself a department of the University of Cambridge.